

PCF 10.00/07/135 3.5SN OR BX

Weidmüller Interface GmbH & Co. KG
 Klingenbergstraße 26
 D-32758 Detmold
 Germany

www.weidmueller.com

Product image

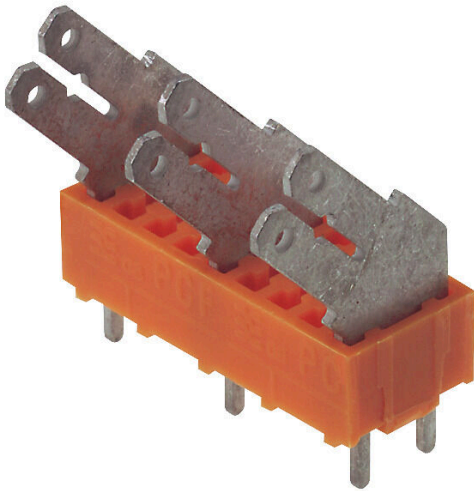

Similar to illustration

Flat-blade connection in 90°, 135° and 180° conductor outlet direction for 6.3 and 2.8 mm spade connector at 10.00 mm pitch

General ordering data

Version	Printed circuit board terminals, 10.00 mm, Number of poles: 7, 135°, Solder pin length (l): 3.5 mm, tinned, orange, Flat-blade connection, Box
Order No.	9512140000
Type	PCF 10.00/07/135 3.5SN OR BX
GTIN (EAN)	4008190558291
Qty.	50 items
Product data	IEC: 1000 V / 24 A UL: 300 V / 15 A
Packaging	Box

PCF 10.00/07/135 3.5SN OR BX

Weidmüller Interface GmbH & Co. KG
 Klingenbergstraße 26
 D-32758 Detmold
 Germany

www.weidmueller.com

Technical data

Approvals

Approvals



ROHS Conform

Dimensions and weights

Depth	9.8 mm	Depth (inches)	0.3858 inch
Height	21.4 mm	Height (inches)	0.8425 inch
Height of lowest version	17.9 mm	Width	64.8 mm
Width (inches)	2.5512 inch	Net weight	7.6 g

Environmental Product Compliance

RoHS Compliance Status Compliant without exemption
 REACH SVHC No SVHC above 0.1 wt%

System parameters

Product family	PCF	Wire connection method	Flat-blade connection
Mounting onto the PCB	THT solder connection	Conductor outlet direction	135°
Pitch in mm (P)	10.00 mm	Pitch in inches (P)	0.394 "
Number of poles	7	Pin series quantity	1
Fitted by customer	No	Number of rows	1
Solder pin length (l)	3.5 mm	Solder pin dimensions	0.8 x 1.0 mm, 0.75 x 0.9 mm
Solder eyelet hole diameter (D)	1.3 mm	Solder eyelet hole diameter tolerance (D)+	0,1 mm
Number of solder pins per pole	2	L1 in mm	60.00 mm
L1 in inches	2.362 "	Touch-safe protection acc. to DIN VDE 0470	IP 00
Protection degree	IP20	Volume resistance	1.20 mΩ

Material data

Insulating material	PA	Colour	orange
Colour chart (similar)	RAL 2000	Insulating material group	I
Comparative Tracking Index (CTI)	≥ 600	Moisture Level (MSL)	
UL 94 flammability rating	V-2	Contact material	Cu-alloy
Contact surface	tinned	Layer structure of solder connection	1.5...3 μm Ni / 5...7 μm Sn
Storage temperature, min.	-40 °C	Storage temperature, max.	70 °C
Operating temperature, min.	-50 °C	Operating temperature, max.	100 °C
Temperature range, installation, min.	-25 °C	Temperature range, installation, max.	100 °C

Conductors suitable for connection

Reference text Length of ferrules is to be chosen depending on the product and the rated voltage., The outside diameter of the plastic collar should not be larger than the pitch (P)

PCF 10.00/07/135 3.5SN OR BX

Weidmüller Interface GmbH & Co. KG
 Klingenbergstraße 26
 D-32758 Detmold
 Germany

www.weidmueller.com

Technical data

Rated data acc. to IEC

tested acc. to standard	IEC 60664-1, IEC 61984	Rated current, min. number of poles (Tu=20°C)	24 A
Rated current, max. number of poles (Tu=20°C)	26 A	Rated current, min. number of poles (Tu=40°C)	24 A
Rated current, max. number of poles (Tu=40°C)	22 A	Rated voltage for surge voltage class / pollution degree II/2	1000 V
Rated voltage for surge voltage class / pollution degree III/2	690 V	Rated voltage for surge voltage class / pollution degree III/3	690 V
Rated impulse voltage for surge voltage class/ pollution degree II/2	6 kV	Rated impulse voltage for surge voltage class/ pollution degree III/2	6 kV
Rated impulse voltage for surge voltage class/ contamination degree III/3	6 kV	Short-time withstand current resistance	3 x 1s mit 192 A

Rated data acc. to CSA

Institute (CSA)	CSA	Certificate No. (CSA)	12400-282
Rated voltage (Use group B / CSA)	300 V	Rated voltage (Use group C / CSA)	300 V
Rated voltage (Use group D / CSA)	300 V	Rated current (Use group B / CSA)	15 A
Rated current (Use group C / CSA)	15 A	Rated current (Use group D / CSA)	10 A
Reference to approval values	Specifications are maximum values, details - see approval certificate.		

Rated data acc. to UL 1059

Rated voltage (Use group B / UL 1059)	300 V	Rated voltage (Use group C / UL 1059)	300 V
Rated voltage (Use group D / UL 1059)	300 V	Rated current (Use group B / UL 1059)	15 A
Rated current (Use group C / UL 1059)	15 A	Rated current (Use group D / UL 1059)	10 A

Packing

Packaging	Box	VPE length	150.00 mm
VPE width	113.00 mm	VPE height	64.00 mm

Type tests

Test: Durability of markings	Test	mark of origin, type identification, approval marking UL, approval marking CSA, durability
	Evaluation	passed

Important note

IPC conformity	Conformity: The products are developed, manufactured and delivered according international recognized standards and norms and comply with the assured properties in the data sheet resp. fulfill decorative properties in accordance with IPC-A-610 "Class 2". Further claims on the products can be evaluated on request.
Notes	<ul style="list-style-type: none"> Long term storage of the product with average temperature of 50 °C and maximum humidity 70%, 36 months

Classifications

ETIM 8.0	EC002643	ETIM 9.0	EC002643
ETIM 10.0	EC002643	ECLASS 14.0	27-46-01-01
ECLASS 15.0	27-46-01-01		

Dimensional drawing

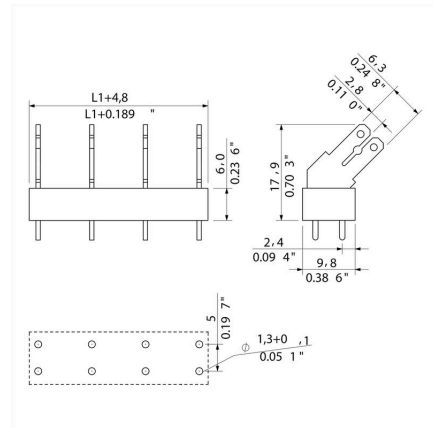

PCF 10.00/07/135 3.5SN OR BX

Weidmüller Interface GmbH & Co. KG
Klingenbergstraße 26
D-32758 Detmold
Germany

www.weidmueller.com

Accessories

Cross-connections



Large potential for small terminals.
For efficient electrical distribution directly at the connection:

- Isolated comb rail
- Available with the most standard pole numbers
- Easy to shorten

Simply reduce in size to match the number of poles and connect with the conductor in a single working procedure.

For retrofitting or deliberate reduction of the thermal load on the PCB.

General ordering data

Type	PCF CROSSLINK 10MM PITCH	Version
Order No.	6382690000	Printed circuit board terminals, Accessories, Cross-connector, Number
GTIN (EAN)	4008190549558	of poles: 2
Qty.	1000 ST	