

MRS 24Vdc 1CO C1D2

Weidmüller Interface GmbH & Co. KG
 Klingenbergstraße 26
 D-32758 Detmold
 Germany

www.weidmueller.com

Product image

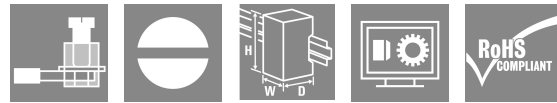
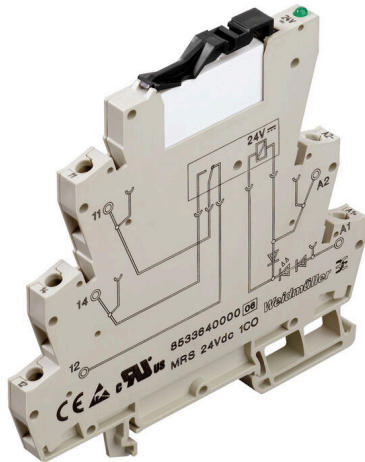

Similar to illustration

General ordering data

Version	MICROSERIES, Relay module, Number of contacts: 1, CO contact AgNi, Rated control voltage: 24 V DC $\pm 20\%$, Continuous current: 6 A, Screw connection, Test button available: No
Order No.	8967350000
Type	MRS 24Vdc 1CO C1D2
GTIN (EAN)	4032248788958
Qty.	10 items
Delivery status	Discontinued
Available until	2016-06-30T00:00:00+02:00
Alternative product	TRS 24VDC 1CO C1D2

MRS 24Vdc 1CO C1D2

Weidmüller Interface GmbH & Co. KG

Klingenbergstraße 26

D-32758 Detmold

Germany

www.weidmueller.com

Technical data

Approvals

ROHS	Conform
------	---------

Dimensions and weights

Depth	94 mm	Depth (inches)	3.7008 inch
Height	93 mm	Height (inches)	3.6614 inch
Width	6.1 mm	Width (inches)	0.2402 inch
Net weight	36.5 g		

Temperatures

Storage temperature	-40 °C...60 °C	Operating temperature	-25 °C...55
Humidity	40 °C / 93 % rel. humidity, no condensation		

Environmental Product Compliance

RoHS Compliance Status	Compliant
REACH SVHC	Lead 7439-92-1
SCIP	0f455e0d-3c4b-49b7-ae9b-28f18844bd32

Control side

Rated control voltage	24 V DC \pm 20 %	Rated current DC	6.6 mA
Power rating	160 mW	Status indicator	Green LED
Protective circuit	Free-wheeling diode, Reverse polarity protection		

Load side

Rated switching voltage	250 V AC	Max. switching frequency at rated load	0.1 Hz
Max. switching voltage, AC	250 V	Max. switching voltage, DC	250 V
Inrush current	6 A	AC switching capacity (resistive), max.	1500 VA
DC switching capacity (resistive), max.	144 W @ 24 V	Switch-on delay	6.6 ms
Switch-off delay	5.8 ms	Contact type	1 CO contact (AgNi)
Mechanical service life	5 x 10 ⁶ switching cycles	Min. switching power	1 mA @ 24 V, 10 mA @ 10 V, 100 mA @ 5 V

General data

Version	cULus C1D2	Mounting rail	TS 35
Test button available	No	Mechanical switch position indicator	No
Colour	beige		

Insulation coordination

Rated voltage	300 V	Pollution severity	2
Surge voltage category	III	Creepage and clearance distance input \geq 5.5 mm output	
Dielectric strength to mounting rail	4 kVeff / 1 Min.	Impulse withstand voltage	4 kV (1.2/50 μ s)
Protection degree	IP20		

Further details of approvals / standards

Standards	UL508
-----------	-------

MRS 24Vdc 1CO C1D2

Weidmüller Interface GmbH & Co. KG
Klingenbergstraße 26
D-32758 Detmold
Germany

www.weidmueller.com

Technical data**Connection data**

Wire connection method	Screw connection	Clamping range, rated connection	2.5 mm ²
Clamping range, min.	0.5 mm ²	Clamping range, max.	4 mm ²
Blade size	0.6 x 3.5 mm		

Classifications

ETIM 8.0	EC001437	ETIM 9.0	EC001437
ETIM 10.0	EC001437	ECLASS 14.0	27-37-16-01
ECLASS 15.0	27-37-16-01		

MRS 24Vdc 1CO C1D2

Weidmüller Interface GmbH & Co. KG
 Klingenbergstraße 26
 D-32758 Detmold
 Germany

www.weidmueller.com

Drawings

Wiring diagram

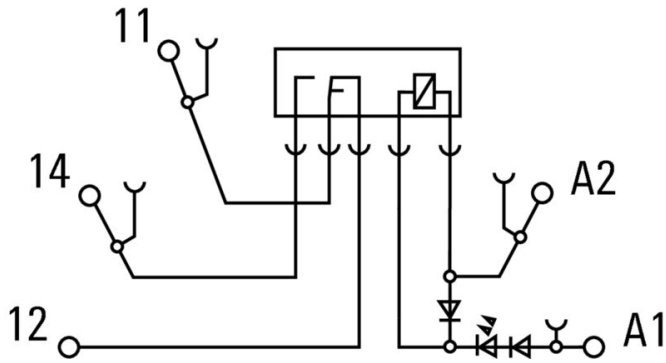

Graph



DC load limit curve

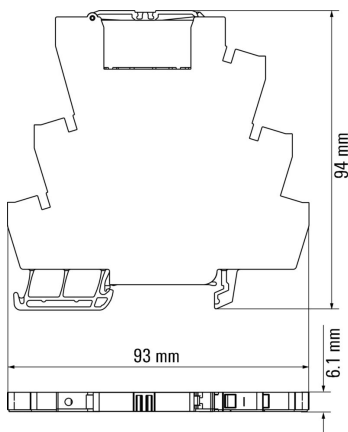
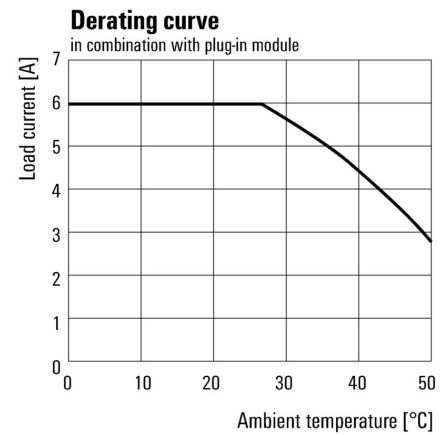
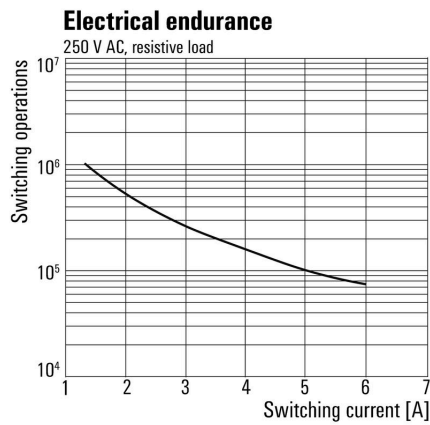

MRS 24Vdc 1CO C1D2

Weidmüller Interface GmbH & Co. KG
 Klingenbergstraße 26
 D-32758 Detmold
 Germany

Accessories

www.weidmueller.com

Cross-connections



The distribution or multiplication of a potential to adjoining terminal blocks is realized via a cross-connection. Additional wiring effort can be easily avoided. Even if the poles are broken out, contact reliability in the terminal blocks is still ensured. Our portfolio offers pluggable and screwable cross-connection systems for modular terminal blocks.

General ordering data

Type	ZQV 4N/2 SW	Version
Order No.	1793970000	W-Series, Cross-connector, 32 A
GTIN (EAN)	4032248233762	
Qty.	60 ST	
Type	ZQV 4N/3 SW	Version
Order No.	1794000000	W-Series, Cross-connector, 32 A
GTIN (EAN)	4032248233793	
Qty.	60 ST	
Type	ZQV 4N/4 SW	Version
Order No.	1794030000	W-Series, Cross-connector, 32 A
GTIN (EAN)	4032248233915	
Qty.	60 ST	
Type	ZQV 4N/10 SW	Version
Order No.	1794060000	W-Series, Cross-connector, 32 A
GTIN (EAN)	4032248234059	
Qty.	20 ST	
Type	ZQV 4N/20 SW	Version
Order No.	1909120000	W-Series, Cross-connector, 32 A
GTIN (EAN)	4032248535804	
Qty.	20 ST	
Type	ZQV 4N/2 GE	Version
Order No.	1758250000	W-Series, Cross-connector, 32 A
GTIN (EAN)	4032248169795	
Qty.	60 ST	
Type	ZQV 4N/3 GE	Version
Order No.	1762630000	W-Series, Cross-connector, 32 A
GTIN (EAN)	4032248169788	
Qty.	60 ST	
Type	ZQV 4N/4 GE	Version
Order No.	1762620000	W-Series, Cross-connector, 32 A
GTIN (EAN)	4032248169771	
Qty.	60 ST	
Type	ZQV 4N/10 GE	Version
Order No.	1758260000	W-Series, Cross-connector, 32 A
GTIN (EAN)	4032248169764	
Qty.	20 ST	
Type	ZQV 4N/20 GE	Version
Order No.	1909020000	W-Series, Cross-connector, 32 A
GTIN (EAN)	4032248535644	
Qty.	20 ST	

MRS 24Vdc 1CO C1D2

Weidmüller Interface GmbH & Co. KG
 Klingenbergstraße 26
 D-32758 Detmold
 Germany

www.weidmueller.com

Accessories

Type	ZQV 4N/2 BL	Version
Order No.	1793960000	W-Series, Cross-connector, 32 A
GTIN (EAN)	4032248233755	
Qty.	60 ST	
Type	ZQV 4N/3 BL	Version
Order No.	1793990000	W-Series, Cross-connector, 32 A
GTIN (EAN)	4032248233786	
Qty.	60 ST	
Type	ZQV 4N/4 BL	Version
Order No.	1794020000	W-Series, Cross-connector, 32 A
GTIN (EAN)	4032248233816	
Qty.	60 ST	
Type	ZQV 4N/10 BL	Version
Order No.	1794050000	W-Series, Cross-connector, 32 A
GTIN (EAN)	4032248234011	
Qty.	20 ST	
Type	ZQV 4N/20 BL	Version
Order No.	1909100000	W-Series, Cross-connector, 32 A
GTIN (EAN)	4032248535774	
Qty.	20 ST	
Type	ZQV 4N/2 RT	Version
Order No.	1793950000	W-Series, Cross-connector, 32 A
GTIN (EAN)	4032248233748	
Qty.	60 ST	
Type	ZQV 4N/3 RT	Version
Order No.	1793980000	W-Series, Cross-connector, 32 A
GTIN (EAN)	4032248233779	
Qty.	60 ST	
Type	ZQV 4N/4 RT	Version
Order No.	1794010000	W-Series, Cross-connector, 32 A
GTIN (EAN)	4032248233809	
Qty.	60 ST	
Type	ZQV 4N/10 RT	Version
Order No.	1794040000	W-Series, Cross-connector, 32 A
GTIN (EAN)	4032248234004	
Qty.	20 ST	
Type	ZQV 4N/20 RT	Version
Order No.	1909150000	W-Series, Cross-connector, 32 A
GTIN (EAN)	4032248535934	
Qty.	20 ST	

Slotted screwdriver



Slotted screwdriver with rounded blade SD DIN 5265, ISO 2380/2, output to DIN 5264, ISO 2380/1. ChromTop tip, SoftFinish grip

MRS 24Vdc 1CO C1D2

Weidmüller Interface GmbH & Co. KG
 Klingenbergstraße 26
 D-32758 Detmold
 Germany

www.weidmueller.com

Accessories

General ordering data

Type	SDS 0.6X3.5X100	Version	
Order No.	2749340000	Screwdriver, Blade width (B): 3.5 mm, Blade length: 100 mm, Blade thickness (A): 0.6 mm	
GTIN (EAN)	4050118895568		
Qty.	1 ST		

LM MT300 15X6

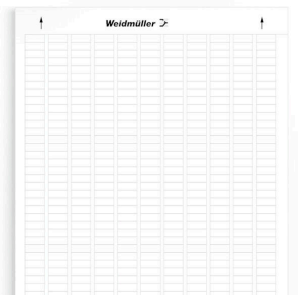

- Adhesive polyester labels
- Suitable for A4 laser printers
- Abrasion-resistant
- High heat resistance
- For marking all kinds of switchgear and modules
- Can also be written on with a ballpoint pen or STI marking pen

General ordering data

Type	LM MT300 15/6 WS	Version	
Order No.	1686361044	LaserMark, Device markers, 6 x 15.2 mm, white	
GTIN (EAN)	4008190493844		
Qty.	10 ST		

Blank



WS markers are the perfect match for the W-series connectors. Thanks to their system compatibility, the WS tags can also be used with the I-series and the Z-series. The large marking surfaces do not only permit long character strings but also multi-line text. WS markers are ideal for labels with long, customised character strings. Thanks to the proven MultiCard format, printing with PrintJet CONNECT oder/or Plotter is possible.

- Can be fitted in strips or individually
- Markers in proven MultiCard format

For custom printing: Please send us a file of our labeling software M-Print PRO or M-Print PRO Online (without installation) for your labeling specifications.

General ordering data

Type	WS 12/6 MC NE WS	Version	
Order No.	1609900000	WS, Terminal marker, 12 x 6 mm, Pitch in mm (P): 6.00 Weidmueller, Allen-Bradley, white	
GTIN (EAN)	4008190203467		
Qty.	600 ST		

MRS 24Vdc 1CO C1D2

Weidmüller Interface GmbH & Co. KG
 Klingenbergstraße 26
 D-32758 Detmold
 Germany

Accessories

www.weidmueller.com

Micro interface digital



Specific adapter to be connected to the MICROSERIE RELAYS using a 10-pole flat-cable connector or 15-pole Sub-D connector.

General ordering data

Type	MI8DI-S F10 S	Version
Order No.	8773510000	Plug-in connector in acc. with IEC60603-13 / DIN41651, Screw connection
GTIN (EAN)	4032248442034	
Qty.	1 ST	
Type	MI8DI-S SUB D15S	Version
Order No.	8773460000	IEC 60603/DIN41612 plug-in connectors, Screw connection
GTIN (EAN)	4032248441990	
Qty.	1 ST	
Type	MI8DO-S F10 S	Version
Order No.	8773600000	Plug-in connector in acc. with IEC60603-13 / DIN41651, Screw connection
GTIN (EAN)	4032248442133	
Qty.	1 ST	
Type	MI8DO-S SUB D15S	Version
Order No.	8773550000	IEC 60603/DIN41612 plug-in connectors, Screw connection
GTIN (EAN)	4032248442089	
Qty.	1 ST	