

ACT20X-SDI-HDO-H-S

Weidmüller Interface GmbH & Co. KG
 Klingenbergstraße 26
 D-32758 Detmold
 Germany

www.weidmueller.com

Product image, Similar to illustration

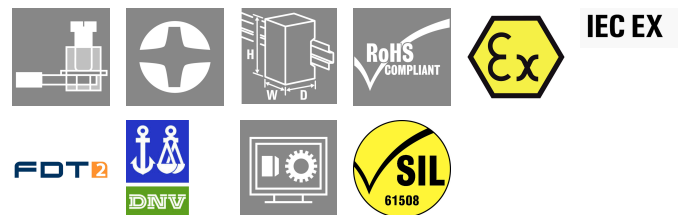

The ACT20X-SDI-HDO/2SDI-2HDO valve control modules are controlled from the safe zone on the input side by the switching signals (NPN, PNP) and provide digital outputs to switch actuators (solenoids, alarms) in Ex zone 0. Depending on the module, the output current is limited for the ignition protection groups IIC/IIB to 35 mA or 60 mA (only one channel). Integrated alarm contacts issue an alert in the event of a malfunction; this makes troubleshooting easier and increases system availability. The rail mounted disconnect-switch amplifiers are optionally available in one- or two-channel versions. With 11 mm width per channel, the devices need little space in the electrical cabinet.

General ordering data

Version	EX signal isolating converter, Safe-input: relay, Ex-output: Opto module, High-current, 1-channel
Order No.	8965410000
Type	ACT20X-SDI-HDO-H-S
GTIN (EAN)	4032248785025
Qty.	1 items

ACT20X-SDI-HDO-H-S

Weidmüller Interface GmbH & Co. KG

Klingenbergstraße 26

D-32758 Detmold

Germany

www.weidmueller.com

Technical data

Approvals

Approvals CE; CULUS; DETNORVER; FMEX; FUSAFETY; IECEXKEM; KEMAATEX

Approvals DNVGL;

Approvals



ROHS Conform

UL File Number Search [UL Website](#)

Certificate no. (cULus) E337701

Dimensions and weights

Depth	113.6 mm	Depth (inches)	4.4724 inch
Height	119.2 mm	Height (inches)	4.6929 inch
Width	22.5 mm	Width (inches)	0.8858 inch
Net weight	170 g		

Temperatures

Storage temperature	-20 °C...85 °C	Operating temperature	-20 °C...60 °C
Humidity	0...95 % (no condensation)		

Probability of failure

SIL PAPER	SIL certificate - PDF/ Cert_Weidmueller_070902_P0002_C004_V2R1.pdf (application/pdf)	SIL in compliance with IEC 61508	2
MTBF	175 a	SFF	91 %

Environmental Product Compliance

RoHS Compliance Status	Compliant with exemption
RoHS Exemption (if applicable/known)	7a, 7cl
REACH SVHC	Lead 7439-92-1
SCIP	2f6dd957-421a-46db-a0c2-cf1609156924

Assembling

Type of mounting	Rail, Snap mounting support rail	Mounting rail	TS 35
Mounting position	horizontal or vertical		

Input

Number inputs	1	Type	NPN, PNP transistor, switching signal [input safe-side valve component]
Input voltage	≤ 28 V DC, Trigger level low: ≤ 2.0 V DC (NPN), ≤ 8.0 V DC (PNP), Trigger level high: ≥ 4.0 V DC (NPN), ≥ 10.0 V DC (PNP)	Input resistance, voltage	3.5 kΩ

ACT20X-SDI-HDO-H-S

Weidmüller Interface GmbH & Co. KG

Klingenbergstraße 26

D-32758 Detmold

Germany

www.weidmueller.com

Technical data

Output

Load impedance current	<300 Ω		
Type	intrinsically safe circuit, digital, output = input, direct or inverse (configurable)		
Output values	Current	max.	60 mA
	Voltage	min.	9 V
	Current	max.	50 mA
	Voltage	min.	11.5 V
	Current	max.	60 mA
	Voltage	min.	10 V
	Current	max.	50 mA
	Voltage	min.	12.5 V
	Current	max.	60 mA
	Voltage	min.	11 V
	Current	max.	50 mA
	Voltage	min.	13.5 V
Output values	depending on terminal assignment: 9 V @ 60 mA / 11.5 V @ 50 mA / 10 V @ 60 mA / 12.5 V @ 50 mA / 11 V @ 60 mA / 13.5 V @ 50 mA		
Number of outputs, Ex	1		
Residual ripple (current loop)	<40 mVeff		
Output values	depending on terminal assignment		

Output (Status)

Hysteresis	0.1 mA (switching threshold)	Type	Status relay, 1 NC (voltage-free)
Alarm function	Failure of power supply, Device error	Number of alarm outputs	1
Nominal switching voltage	≤ 125 V AC / 110 V DC (safe area) ≤ 32 V AC / 32 V DC (zone 2)	Continuous current	≤ 0.5 A AC / 0.3 A DC (safe zone), ≤ 0.5 A AC / 1 A DC (zone 2)
Power rating	≤ 62.5 VA / 32 W (safe area) ≤ 16 VA / 32 W (Zone 2)		

General specifications

Type of connection	Screw connection	Humidity	0...95 % (no condensation)
Protection degree	IP20	Supply voltage	19.2...31.2 V DC
Step response time	10 ms	Configuration	With FDT/DTM software, Requires configuration adapter 8978580000 CBX200 USB
Operating altitude	≤ 2000 m	Heat dissipation	$\leq 1,7$ W

Insulation coordination

EMC standards	EN 61326-1	Standards	EN 61010-1
Insulation voltage	2.6 kV (input / output)	Rated voltage	300 V

Data for Ex applications (ATEX)

ATEX - gas labelling	II (1) G [Ex ia Ga] IIC/IIB/IIA	ATEX - dust labelling	II (1) D [Ex ia Da] IIIC, I (M1) [Ex ia Ma] I
IECEx - gas labelling	Ex ec nC IIC T4 Gc, [Ex ia Ga] IIC/IIB/IIA	Installation location	Device installed in safe area, zone 2

ACT20X-SDI-HDO-H-S

Weidmüller Interface GmbH & Co. KG

 Klingenbergstraße 26
 D-32758 Detmold
 Germany

www.weidmueller.com

Technical data

Connection data

Type of connection	Screw connection	Tightening torque, min.	0.4 Nm
Tightening torque, max.	0.6 Nm	Clamping range, rated connection	2.5 mm ²
Clamping range, min.	0.25 mm ²	Clamping range, max.	2.5 mm ²
Wire connection cross section AWG, min.	AWG 26	Wire connection cross section AWG, max.	AWG 12

Guarantee

Time interval	3 years
---------------	---------

Part description

Product description	<p>The ACT20X-SDI-HDO-S solenoid valve switch/alarm transmitter has one input in the non-hazardous area and one output in the hazardous area Zone 0. The device is suitable for switching e.g. magnetic valves or alarm transmitters. The device is available as single-channel or dual-channel version.</p> <p>Features</p> <ul style="list-style-type: none"> • Solenoid valve switch / alarm transmitter for the control of solenoids, acoustic alarms and LED's installed in the hazardous area. • Two variants with 35 mA or 60 mA output current are available in 1-channel or 2-channel versions. • Configuration and diagnosis via FDT/DTM Software "WI-Manager". • Selection of direct or inverted function for each channel and the possibility of reducing the output current to the hazardous area to suit the application. • The device can be mounted in the safe area and in Zone 2 / Division 2 and receive signals from Zone 0, 1, 2, 20, 21 and 22, as well as Class I/II/III, Division 1, Group A-G. • Extended self diagnostic: Monitoring of error events via the individual status relay. • LED indication: green and 2 yellow/red front LED's to indicate operation status and malfunction • 3-way galvanic isolation between input, output and power supply.
---------------------	--

Classifications

ETIM 8.0	EC002653	ETIM 9.0	EC002653
ETIM 10.0	EC002653	ECLASS 14.0	27-21-01-20
ECLASS 15.0	27-21-01-20		

Connection diagram

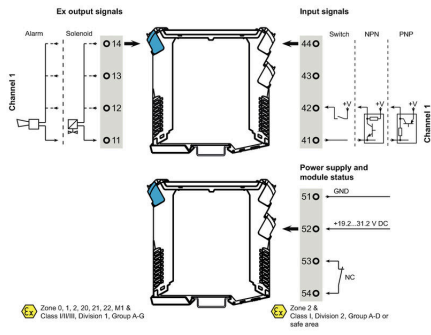

Application



Block diagram

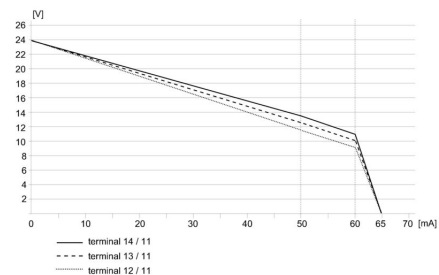
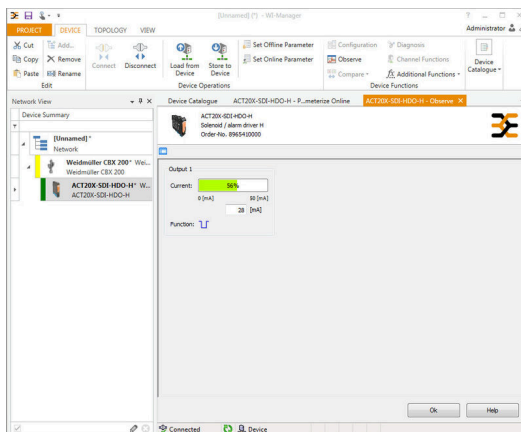
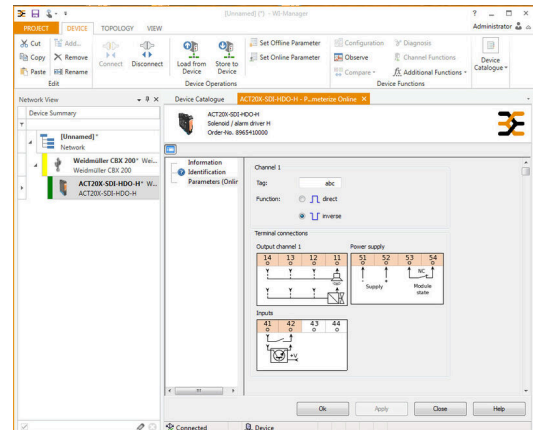
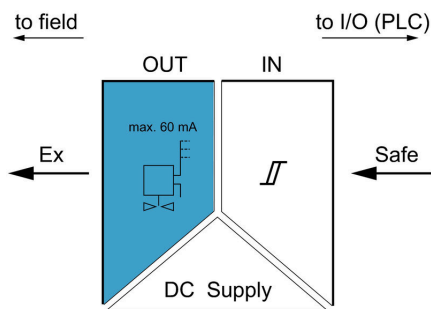

ACT20X-SDI-HDO-H-S

Weidmüller Interface GmbH & Co. KG
Klingenbergstraße 26
D-32758 Detmold
Germany

Drawings

www.weidmueller.com

Dimensioned drawing

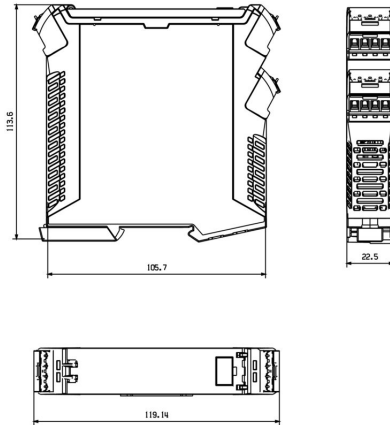

Removable terminals with coding

ACT20X-SDI-HDO-H-S

Weidmüller Interface GmbH & Co. KG
 Klingenbergstraße 26
 D-32758 Detmold
 Germany

www.weidmueller.com

Accessories

Blank



ESG is the tried-and-tested marker in MultiCard format for use on many well-known electrical devices. The result is high-quality device marking with a high-contrast appearance.

Various types are available for devices from manufacturers like Siemens, ABB, Beckhoff etc.

Advantages at a glance:

- Tags for universal usage, self-adhesive or clip-on tags, depending on type
- For aligned equipment, e.g. circuit breakers, we supply ESG markers for clipping onto tag rails
- Individual laser-quality printing according to specifications

For custom printing: Please send us a file of our labeling software M-Print PRO or M-Print PRO Online (without installation) for your labeling specifications.

General ordering data

Type	ESG 6.6/20 BHZ 5.00/04	Version	
Order No.	1082540000	ESG, Device markers x 20 mm, PA 66, Colour: white, pluggable	
GTIN (EAN)	4032248845439		
Qty.	200 ST		
Type	ESG 8/13.5/43.3 SAI AU	Version	
Order No.	1912130000	ESG, Device markers x 13.5 mm, PA 66, Colour: Transparent, pluggable	
GTIN (EAN)	4032248541164		
Qty.	5 ST		

Configuration interfaces



General ordering data

Type	CBX200 USB	Version	
Order No.	8978580000		
GTIN (EAN)	4032248813759		
Qty.	1 ST		