

RCMKIT-I 24VDC 3CO LD

Weidmüller Interface GmbH & Co. KG
 Klingenbergstraße 26
 D-32758 Detmold
 Germany

www.weidmueller.com

Product image

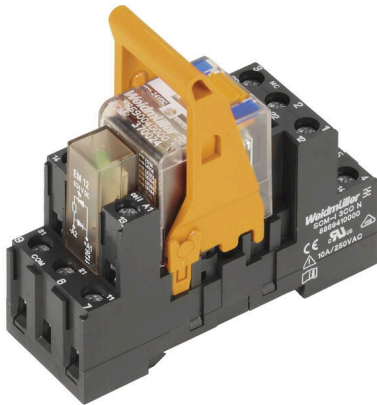

- Mounted kit consisting relay, socket and retaining clip
- 100 % function tested
- 100 % check of the dielectric strenght between input - output
- 3 CO contacts
- Test button with mechanical status indicator
- Bright status LED (AC coil: red / DC coil: green)
- Identification of coils (AC red / DC blue)

General ordering data

Version	RIDERSERIES RCM, Relay module, Number of contacts: 3, CO contact AgNi, Rated control voltage: 24 V DC, Continuous current: 10 A, Screw connection, Test button available: Yes
Order No.	8920980000
Type	RCMKIT-I 24VDC 3CO LD
GTIN (EAN)	403224869223 1
Qty.	10 items
Delivery status	This article will no longer be available in the future.
Available until	2026-01-31T00:00:00+01:00

RCMKIT-I 24VDC 3CO LD

Weidmüller Interface GmbH & Co. KG
 Klingenbergstraße 26
 D-32758 Detmold
 Germany

www.weidmueller.com

Technical data

Approvals

Approvals



ROHS Conform

Dimensions and weights

Depth	71.6 mm	Depth (inches)	2.8189 inch
Height	73.5 mm	Height (inches)	2.8937 inch
Width	27.2 mm	Width (inches)	1.0709 inch
Net weight	86.95 g		

Temperatures

Storage temperature	-40 °C...70 °C	Ambient temperature	-40 °C...70 °C
Operating temperature		Humidity	40 °C / 93 % rel. humidity, no condensation

Environmental Product Compliance

RoHS Compliance Status	Compliant without exemption
REACH SVHC	No SVHC above 0.1 wt%

Control side

Rated control voltage	24 V DC	Rated current DC	32.8 mA
Power rating	804 mW	Coil resistance	777 Ω ± 10 %
Status indicator	Green LED	Protective circuit	Free-wheeling diode

Load side

Rated switching voltage	240 V AC	Continuous current	10 A
Max. switching frequency at rated load	0.1 Hz	Max. switching voltage, AC	250 V
Inrush current	20 A / 20 ms	AC switching capacity (resistive), max.	2500 VA
DC switching capacity (resistive), max.	240 W @ 24 V	Switch-on delay	≤ 15 ms
Switch-off delay	≤ 10 ms	Contact type	3 CO contact (AgNi)
Mechanical service life	AC coil 20 x 106 switching cycles, DC coil 30 x 106 switching cycles	Min. switching power	1 mA @ 24 V, 10 mA @ 12 V, 100 mA @ 5 V

General data

Mounting rail	TS 35	Test button available	Yes
Version of test button	Lockable test button, Momentary test button	Mechanical switch position indicator	Yes
Colour	black		

Insulation coordination

Rated voltage	250 V	Pollution severity	2
Surge voltage category	III	Insulating material group	IIIa
Clearance and creepage distances for control side - load side	≥ 4 mm	Dielectric strength for control side - load side	2.5 kVeff / 1 Min.
Dielectric strength of neighbouring contacts	2.5 kVeff / 1 Min.	Dielectric strength of open contact	1.2 kVeff / 1 min.

RCMKIT-I 24VDC 3CO LD

Weidmüller Interface GmbH & Co. KG
 Klingenbergstraße 26
 D-32758 Detmold
 Germany

www.weidmueller.com

Technical data

Impulse withstand voltage	5 kV (1.2/50 µs)	Protection degree	IP20
---------------------------	------------------	-------------------	------

Further details of approvals / standards

Relevant rim module	RIM-I 2 6/24VDC GN	Relevant relay	RCM370024
Relevant base	SCM-I 3CO N	Certificate no. (CSA) relay	249409-2426937
Certificate no. (CSA) base	249409-2295474	Certificate No. (DNV)	TAA000011A
Certificate no. (cURus) relay	E522350	Certificate no. (cURus) base	E223759

Connection data

Wire connection method	Screw connection	Stripping length, rated connection	8 mm
Tightening torque, min.	0.5 Nm	Tightening torque, max.	0.7 Nm
Clamping range, rated connection	2.5 mm ²	Clamping range, min.	1 mm ²
Clamping range, max.	2.5 mm ²	Wire cross-section, solid, min.	1 mm ²
Wire cross-section, solid, max.	2.5 mm ²	Wire connection cross section, finely stranded, min.	1 mm ²
Wire connection cross section, finely stranded, max.	2.5 mm ²	Wire connection cross-section, finely stranded with wire-end ferrules DIN 46228/4, min.	1 mm ²
Wire connection cross-section, finely stranded with wire-end ferrules DIN 46228/4, max.	2.5 mm ²	Conductor cross-section, flexible, AEH (DIN 46228-1), min.	1 mm ²
Conductor cross-section, flexible, AEH (DIN 46228-1), max.	2.5 mm ²	Wire connection cross section, finely stranded, two clampable wires, min.	1 mm ²
Wire cross-section, finely stranded, two clampable wires, max.	1.5 mm ²	Blade size	size PZ1

Important note

Product information	IP20 without connected conductor at complete opened clamping yoke connection.
---------------------	---

Classifications

ETIM 8.0	EC001437	ETIM 9.0	EC001437
ETIM 10.0	EC001437	ECLASS 14.0	27-37-16-01
ECLASS 15.0	27-37-16-01		

RCMKIT-I 24VDC 3CO LD

Weidmüller Interface GmbH & Co. KG
 Klingenbergstraße 26
 D-32758 Detmold
 Germany

www.weidmueller.com

Drawings

Wiring diagram

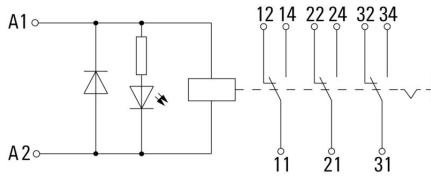

Graph

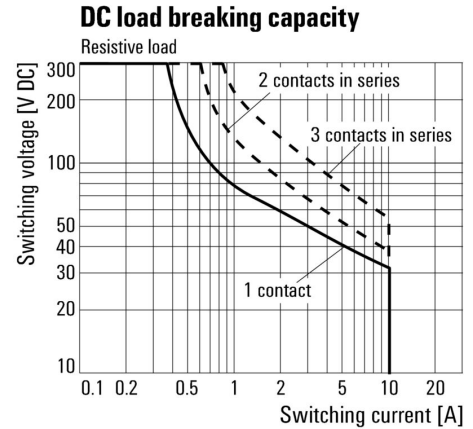

DC load limit curve Resistive load

Graph

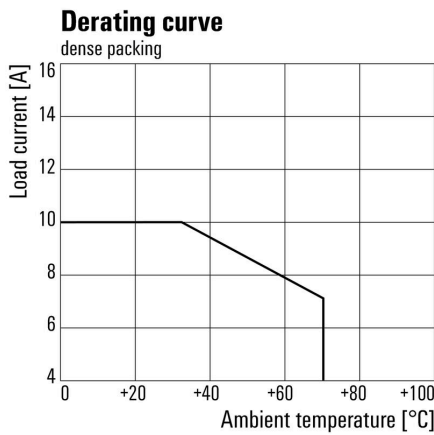

Derating curve Relay in combination with base

Graph

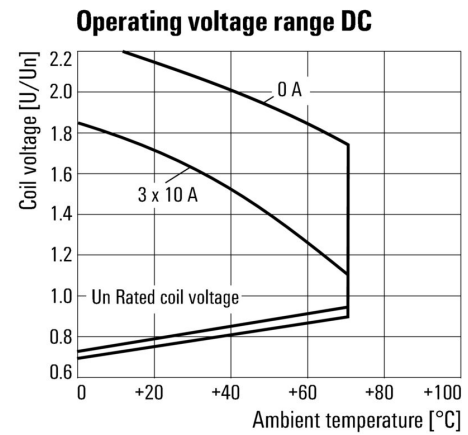

DC operational voltage range

RCMKIT-I 24VDC 3CO LD

Weidmüller Interface GmbH & Co. KG
 Klingenbergstraße 26
 D-32758 Detmold
 Germany

www.weidmueller.com

Drawings

Graph

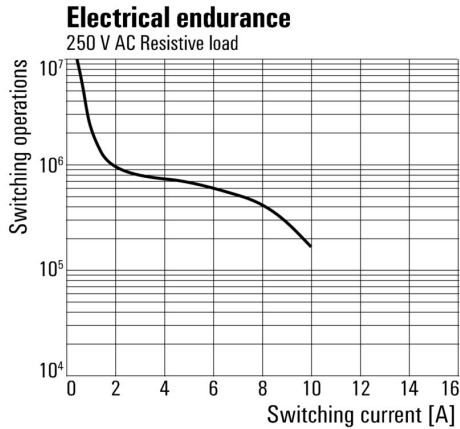

Electrical service life 250 V AC
 resistive load 250 V AC resistive load

Dimensional drawing

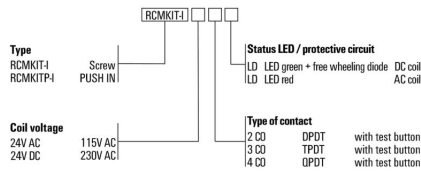
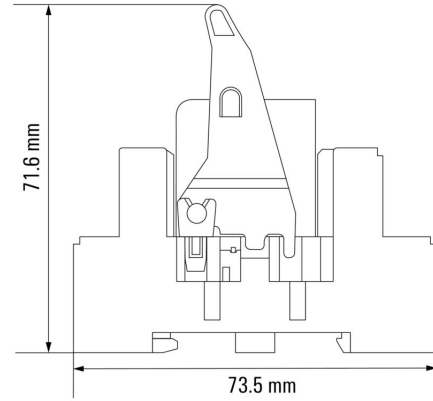

RCMKIT-I 24VDC 3CO LD

Weidmüller Interface GmbH & Co. KG
 Klingenbergstraße 26
 D-32758 Detmold
 Germany

www.weidmueller.com

Accessories

Cross-connection for socket with screw connection

Cross-connection for the sockets in the D-SERIES DRM.

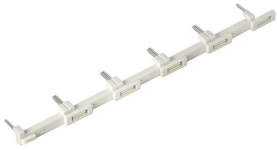

General ordering data

Type	SCM-I QV S	Version	
Order No.	1132080000	RIDERSERIES RCM, Cross-connector	
GTIN (EAN)	4032248912193		
Qty.	10 ST		

Protection module



Pluggable protective modules for the RIDERSERIES RCI / RCM relay sockets, with optional protective functions.

- Optional with free-wheeling diode, protective varistor, load resistor or RC filter

General ordering data

Type	RIM-I 1 6/230V	Version	
Order No.	8869580000	RIDERSERIES, Free-wheeling diode, Rated control voltage: 6...230 V	
GTIN (EAN)	4032248614523	DC, Plug-in connection	
Qty.	10 ST		

LED / Free-wheel diode



Pluggable protective modules for the RIDERSERIES RCI / RCM relay sockets, with optional protective functions.

- Optional with green or red LED
- With free-wheeling diode
- For DC supply voltage

General ordering data

Type	RIM-I 2 24/60VDC	Version	
Order No.	8869670000	RIDERSERIES, LED module with freewheel diode, Rated control voltage: 24...60 V DC, Plug-in connection	
GTIN (EAN)	4032248614608		
Qty.	10 ST		

RCMKIT-I 24VDC 3CO LD

Weidmüller Interface GmbH & Co. KG
 Klingenbergstraße 26
 D-32758 Detmold
 Germany

www.weidmueller.com

Accessories

Type	RIM-I 2 24/60VDC GN	Version
Order No.	8869680000	RIDERSERIES, LED module with freewheel diode, Rated control
GTIN (EAN)	4032248614615	voltage: 24...60 V DC, Plug-in connection
Qty.	10 ST	
Type	RIM-I 2 6/24VDC	Version
Order No.	8869590000	RIDERSERIES, LED module with freewheel diode, Rated control
GTIN (EAN)	4032248614530	voltage: 6...24 V DC, Plug-in connection
Qty.	10 ST	
Type	RIM-I 2 6/24VDC GN	Version
Order No.	8869600000	RIDERSERIES, LED module with freewheel diode, Rated control
GTIN (EAN)	4032248614547	voltage: 6...24 V DC, Plug-in connection
Qty.	10 ST	

LED



Pluggable protective modules for the RIDERSERIES RCI / RCM relay sockets, with optional protective functions.

- Optional with green or red LED
- For UC supply voltage

General ordering data

Type	RIM-I 3 24/60VUC	Version
Order No.	8869610000	RIDERSERIES, LED module, Rated control voltage: 24...60 V UC, Plug-
GTIN (EAN)	4032248614554	in connection
Qty.	10 ST	
Type	RIM-I 3 24/60VUC GN	Version
Order No.	8869620000	RIDERSERIES, LED module, Rated control voltage: 24...60 V UC, Plug-
GTIN (EAN)	4032248614561	in connection
Qty.	10 ST	
Type	RIM-I 3 6/24VUC	Version
Order No.	8869630000	RIDERSERIES, LED module, Rated control voltage: 6...24 V UC, Plug-in
GTIN (EAN)	4032248614578	connection
Qty.	10 ST	
Type	RIM-I 3 6/24VUC GN	Version
Order No.	8869640000	RIDERSERIES, LED module, Rated control voltage: 6...24 V UC, Plug-in
GTIN (EAN)	4032248614585	connection
Qty.	10 ST	

RCMKIT-I 24VDC 3CO LD

Weidmüller Interface GmbH & Co. KG
 Klingenbergstraße 26
 D-32758 Detmold
 Germany

www.weidmueller.com

Accessories

Protective varistor



Pluggable protective modules for the RIDERSERIES RCI / RCM relay sockets, with optional protective functions.

- With protective varistor
- For UC supply voltage

General ordering data

Type	RIM-I 4 24VUC VAR	Version	
Order No.	8869710000	RIDERSERIES, Protective varistor, Rated control voltage: 24 V UC,	
GTIN (EAN)	4032248606344	Plug-in connection	
Qty.	10 ST		

Retaining clips



Retaining clip for RIDERSERIES RCM relays

- Metal and plastic retaining clip

General ordering data

Type	SCM-I CLIP M	Version	
Order No.	8869450000	RIDERSERIES RCM, Retaining clip	
GTIN (EAN)	4032248614301		
Qty.	10 ST		
Type	SCM-I CLIP P	Version	
Order No.	8869440000	RIDERSERIES RCM, Retaining clip	
GTIN (EAN)	4032248614295		
Qty.	10 ST		

RCMKIT-I 24VDC 3CO LD

Weidmüller Interface GmbH & Co. KG
 Klingenbergstraße 26
 D-32758 Detmold
 Germany

www.weidmueller.com

Accessories

Blank

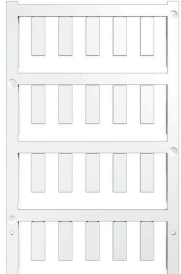

ESG is the tried-and-tested marker in MultiCard format for use on many well-known electrical devices. The result is high-quality device marking with a high-contrast appearance.

Various types are available for devices from manufacturers like Siemens, ABB, Beckhoff etc.

Advantages at a glance:

- Tags for universal usage, self-adhesive or clip-on tags, depending on type
- For aligned equipment, e.g. circuit breakers, we supply ESG markers for clipping onto tag rails
- Individual laser-quality printing according to specifications

For custom printing: Please send us a file of our labeling software M-Print PRO or M-Print PRO Online (without installation) for your labeling specifications.

General ordering data

Type	ESG 6/17 K MC NE WS	Version
Order No.	1880120000	ESG, Device markers x 17 mm, PA 66, Colour: white, Self-adhesive
GTIN (EAN)	4032248478804	
Qty.	200 ST	
Type	ESG 6/15 K MC NE GE	Version
Order No.	1880130000	ESG, Device markers x 15 mm, PA 66, Colour: yellow, Self-adhesive
GTIN (EAN)	4032248478910	
Qty.	200 ST	
Type	ESG 6/15 K MC NE WS	Version
Order No.	1880100000	ESG, Device markers x 15 mm, PA 66, Colour: white, Self-adhesive
GTIN (EAN)	4032248478781	
Qty.	200 ST	
Type	ESG 6/17 K MC NE GE	Version
Order No.	1880110000	ESG, Device markers x 17 mm, PA 66, Colour: yellow, Self-adhesive
GTIN (EAN)	4032248478798	
Qty.	200 ST	

Crosshead screwdriver, Pozidrive



VDE insulated screwdriver sets, for working on live parts up to 1000 V AC and 1500 V DC, DIN EN 60900. IEC 900. Each piece is "GS" safety tested. Blade made from fully hardened, high-alloy chromium-vanadium-molybdenum steel, gun-metal finish.

General ordering data

Type	SDIK SLIM PZ1 X 80	Version
Order No.	2749670000	Screwdriver, Blade width (B): 1 mm, 80 mm, Blade thickness (A): 1
GTIN (EAN)	4050118896411	
Qty.	1 ST	

RCMKIT-I 24VDC 3CO LD

Weidmüller Interface GmbH & Co. KG
 Klingenbergstraße 26
 D-32758 Detmold
 Germany

www.weidmueller.com

Accessories

Crosshead screwdriver Pozidriv



VDE insulated crosshead screwdriver type Pozidriv SDIK PZ DIN 7438, ISO 8764/2-PZ, output to ISO 8764-PZ, SoftFinish grip

General ordering data

Type	SDIK PZ1 X 80	Version	
Order No.	2749920000	Screwdriver, Blade width (B): 1 mm, 80 mm, Blade thickness (A): 1	
GTIN (EAN)	4050118897227		
Qty.	1 ST		
Type	SDK PZ1 X 80	Version	
Order No.	2749440000	Screwdriver, Blade width (B): 14.5 mm, 80 mm, Blade thickness (A): 1	
GTIN (EAN)	4050118895667		
Qty.	1 ST		

ESG 6/15



Guaranteed long service life: ESG

The multi-colour and multi-format labels have a strong adhesive layer to ensure the best possible adhesion to the underlying surface. Double laminated polyester makes the basic material very thin and yet extremely tear-resistant. Your benefits with MultiMark

- "Different materials for various requirements"
- Can be used with equipment from many manufacturers
- Device markers with a familiar design

General ordering data

Type	ESG 6/15 MM WS	Version	
Order No.	2619940000	ESG, Device markers, 6 x 15 mm, white	
GTIN (EAN)	4050118626148		
Qty.	3000 ST		

ESG 6/17



Guaranteed long service life: ESG

The multi-colour and multi-format labels have a strong adhesive layer to ensure the best possible adhesion to the underlying surface. Double laminated polyester makes the basic material very thin and yet extremely tear-resistant. Your benefits with MultiMark

- "Different materials for various requirements"
- Can be used with equipment from many manufacturers
- Device markers with a familiar design

RCMKIT-I 24VDC 3CO LD

Weidmüller Interface GmbH & Co. KG
 Klingenbergstraße 26
 D-32758 Detmold
 Germany

www.weidmueller.com

Accessories

General ordering data

Type	ESG 6/17 MM WS	Version	
Order No.	2005100000	ESG, Device markers, 6 x 17 mm, white	
GTIN (EAN)	4050118390728		
Qty.	3000 ST		

Blank

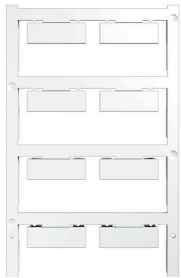

ESG is the tried-and-tested marker in MultiCard format for use on many well-known electrical devices. The result is high-quality device marking with a high-contrast appearance.

Various types are available for devices from manufacturers like Siemens, ABB, Beckhoff etc.

Advantages at a glance:

- Tags for universal usage, self-adhesive or clip-on tags, depending on type
- For aligned equipment, e.g. circuit breakers, we supply ESG markers for clipping onto tag rails
- Individual laser-quality printing according to specifications

For custom printing: Please send us a file of our labeling software M-Print PRO or M-Print PRO Online (without installation) for your labeling specifications.

General ordering data

Type	ESG 9/26 SCM-I MC NE WS	Version	
Order No.	2558330000	ESG, Device markers x 26 mm, PA 66, Colour: white, pluggable	
GTIN (EAN)	4050118569049		
Qty.	80 ST		