

RCI374S15

Weidmüller Interface GmbH & Co. KG

Klingenbergstraße 26
D-32758 Detmold
Germany

www.weidmueller.com

Product image

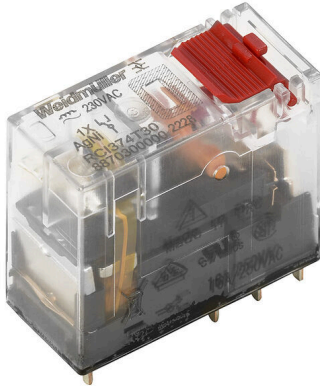

Similar to illustration

Individual relays within the RIDERSERIES RCI

- 1 CO contact
- AC coils
- With integrated status LED and test button

General ordering data

Version	RIDERSERIES RCI, Relay, Number of contacts: 1, CO contact AgNi, Rated control voltage: 115 V AC, Continuous current: 16 A, Plug-in connection, Test button available: Yes
Order No.	8870290000
Type	RCI374S15
GTIN (EAN)	4032248613663
Qty.	10 items
Delivery status	This article will no longer be available in the future.
Available until	2024-10-31T00:00:00+01:00
Alternative product	CRI10615T

Creation date 25.02.2026 08:00:16 MEZ

Catalogue status / Drawings

RCI374S15

Weidmüller Interface GmbH & Co. KG

Klingenbergstraße 26

D-32758 Detmold

Germany

www.weidmueller.com

Technical data

Approvals

Approvals



ROHS Conform

Dimensions and weights

Depth	26.7 mm	Depth (inches)	1.0512 inch
Height	29 mm	Height (inches)	1.1417 inch
Width	13 mm	Width (inches)	0.5118 inch
Net weight	13.91 g		

Temperatures

Storage temperature	-40 °C...85 °C	Ambient temperature	-40 °C...70 °C
Operating temperature		Humidity	40 °C / 93 % rel. humidity, no condensation

Environmental Product Compliance

RoHS Compliance Status	Compliant without exemption
REACH SVHC	No SVHC above 0.1 wt%

Control side

Rated control voltage	115 V AC	Rated current AC	7.1 mA
Power rating	814 mVA	Coil resistance	8100 Ω ± 15 %
Status indicator	red LED		

Load side

Rated switching voltage	240 V AC	Continuous current	16 A
Max. switching frequency at rated load	0.1 Hz	Max. switching voltage, AC	250 V
Inrush current	30 A / 4 s	AC switching capacity (resistive), max.	4000 VA
DC switching capacity (resistive), max.	384 W @ 24 V	Switch-on delay	≤ 8 ms
Switch-off delay	≤ 6 ms	Contact type	1 CO contact (AgNi)
Mechanical service life	AC coil 5 x 106 switching cycles, DC coil 10 x 106 switching cycles	Min. switching power	1 mA @ 24 V, 10 mA @ 12 V, 100 mA @ 5 V

General data

Test button available	Yes	Version of test button	lockable, just when removing the detend lock, Momentary test button
Mechanical switch position indicator	Yes	Colour	Transparent
UL 94 flammability rating	V-2		

Insulation coordination

Rated voltage	250 V	Pollution severity	2
Surge voltage category	III	Insulating material group	IIIa

RCI374S15

Weidmüller Interface GmbH & Co. KG
Klingenbergstraße 26
D-32758 Detmold
Germany

www.weidmueller.com

Technical data

Clearance and creepage distances for control side - load side	≥ 8 mm	Dielectric strength for control side - load side	5 kVeff / 1min
Dielectric strength of open contact	1 kVeff / 1 min	Impulse withstand voltage	5 kV (1.2/50 µs)

Further details of approvals / standards

Certificate No. (CSA) 249409-2426937

Connection data

Wire connection method Plug-in connection Pitch in mm (P) 5.00 mm

Classifications

ETIM 8.0	EC001437	ETIM 9.0	EC001437
ETIM 10.0	EC001437	ECLASS 14.0	27-37-16-01
ECLASS 15.0	27-37-16-01		

Drawings

Wiring diagram

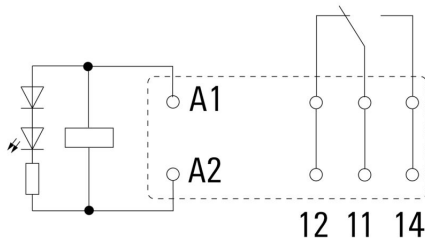

View of Pins from below

Graph



DC load limit curve Resistive load

Graph

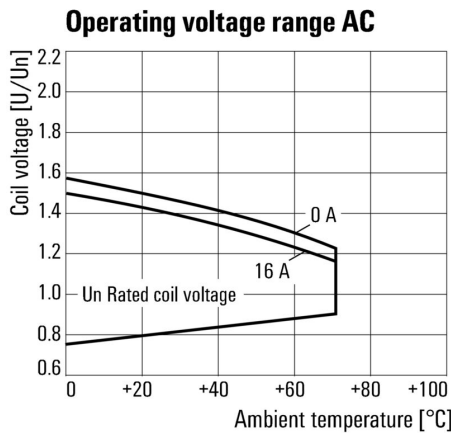

AC operational voltage range

Graph



Electrical service life 250 V AC resistive load

Dimensional drawing

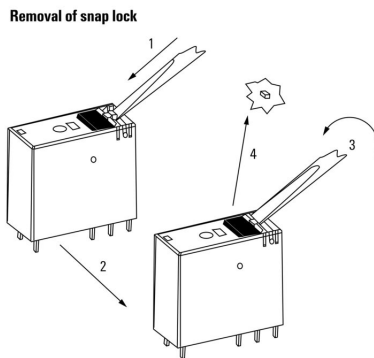

Detailed drawing Removal of the test button detent lock

Derating curve



* For full continuous current (16 A), the wire terminals 11 with 21, 12 with 22 and 14 with 24 must be bridged with a wire $\geq 1,5 \text{ mm}^2$ at the socket.

Relay in combination with base

Dimensional drawing

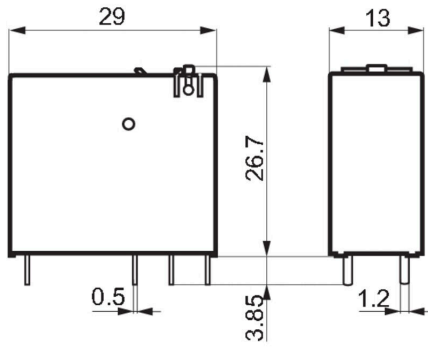

Miscellaneous

	RCI				
Type RIDER Control Industrial					
Type of construction 3 16 A pinning 5 mm 4 8 A, pinning 5mm					
Type of contact 1 1 CO without push button 2 2 CO without push button 7 1 CO with push button 8 2 CO with push button					
Contact material 4 AgNi 90/10					
					Coil voltage
					012 12 V DC
					024 24 V DC
					048 48 V DC
					110 110 V DC
					AB2 12 V DC + LED + diode
					AC4 24 V DC + LED + diode
					AE8 48 V DC + LED + diode
					BB0 110 V DC + LED + diode
					524 24 V AC
					615 115 V AC
					730 230 V AC
					R24 24 V AC + LED
					S15 115 V AC + LED
					T30 230 V AC + LED

Type codes

RCI374S15

Weidmüller Interface GmbH & Co. KG

Klingenbergstraße 26
D-32758 Detmold
Germany

www.weidmueller.com

Accessories

Sockets



Relay sockets for the RIDERSERIES RCI relays

- 1 and 2 CO contacts
- Screw and PUSH IN connection
- Standard and low heights

General ordering data

Type	SRC-I 2CO	Version	
Order No.	8869490000	RIDERSERIES RCI, Relay socket, Number of contacts: 2, CO contact,	
GTIN (EAN)	4032248614448	Continuous current: 8 A, Screw connection	
Qty.	10 ST		
Type	SRC-I 2CO N	Version	
Order No.	8869480000	RIDERSERIES RCI, Relay socket, Number of contacts: 2, CO contact,	
GTIN (EAN)	4032248614431	Continuous current: 8 A, Screw connection	
Qty.	10 ST		
Type	SRC-I 2CO P	Version	
Order No.	8869500000	RIDERSERIES RCI, Relay socket, Number of contacts: 2, CO contact,	
GTIN (EAN)	4032248614455	Continuous current: 8 A, PUSH IN	
Qty.	10 ST		

Cross-connection for socket with PUSH IN connection

Cross-connection for the sockets in the RIDERSERIES RCI.



General ordering data

Type	SRC-I QV P	Version	
Order No.	8870840000	RIDERSERIES RCI, Cross-connector	
GTIN (EAN)	4032248631681		
Qty.	10 ST		

RCI374S15

Weidmüller Interface GmbH & Co. KG
Klingenbergstraße 26
D-32758 Detmold
Germany

www.weidmueller.com

Accessories

Cross-connection for socket with screw connection

Cross-connection for the sockets in the D-SERIES DRI.



General ordering data

Type	SRC-I QV S	Version	
Order No.	1132070000	RIDERSERIES RCI, Cross-connector	
GTIN (EAN)	4032248912087		
Qty.	10 ST		

Retaining clips



Retaining clip for RIDERSERIES RCI relays
• Metal and plastic retaining clip

General ordering data

Type	SRC-I CLIP HP	Version	
Order No.	8869510000	RIDERSERIES RCI, Retaining clip	
GTIN (EAN)	4032248614462		
Qty.	10 ST		

RCI374S15

Weidmüller Interface GmbH & Co. KG
 Klingenbergstraße 26
 D-32758 Detmold
 Germany

www.weidmueller.com

Accessories

Individual components



Relay modules with forcibly guided contacts
 Relays with forcibly guided contacts have a 99 % diagnostics coverage and an excellent reputation for use in safety systems. The contacts interlock mechanically with each other in order to ensure a synchronous switching status of both contacts. This guarantees that the alert contact will maintain the same switching status in the event of an error (for example, if the working contact welds from an overload). The controller (or safety controller) detects the alert contact and then compares the set values and actual values. If a difference occurs, measures can then be taken to protect equipment and human life.

- 2 CO contacts with 6 A, forcibly guided according to EN 61810-3 type B
- Proven component in safety technology
- Diagnosis coverage of 99 %

General ordering data

Type	SRC-I CLIP HM RCI	Version	
Order No.	1132090000	RIDERSERIES RCI, Retaining clip	
GTIN (EAN)	4032248912209		
Qty.	20 ST		

Protection module



Pluggable protective modules for the RIDERSERIES RCI / RCM relay sockets, with optional protective functions.

- Optional with free-wheeling diode, protective varistor, load resistor or RC filter

General ordering data

Type	RIM-I 1 6/230V	Version	
Order No.	8869580000	RIDERSERIES, Free-wheeling diode, Rated control voltage: 6...230 V	
GTIN (EAN)	4032248614523	DC, Plug-in connection	
Qty.	10 ST		
Type	RIM-I 1 R 110/230V	Version	
Order No.	8870830000	RIDERSERIES, Load, Rated control voltage: 110...230 V UC, Plug-in connection	
GTIN (EAN)	4032248631674		
Qty.	10 ST		
Type	RIM-I 3 110/230VAC RC	Version	
Order No.	8869790000	RIDERSERIES, RC filter, Rated control voltage: 110...230 V UC, Plug-in connection	
GTIN (EAN)	4032248606337		
Qty.	10 ST		

RCI374S15

Weidmüller Interface GmbH & Co. KG

Klingenbergstraße 26
D-32758 Detmold
Germany

www.weidmueller.com

Accessories

LED



Pluggable protective modules for the RIDERSERIES RCI / RCM relay sockets, with optional protective functions.

- Optional with green or red LED
- For UC supply voltage

General ordering data

Type	RIM-I 3 110/230VUC	Version	
Order No.	8869650000	RIDERSERIES, LED module, Rated control voltage: 110...230 V UC,	
GTIN (EAN)	4032248614592	Plug-in connection	
Qty.	10 ST		

Type	RIM-I 3 110/230VUC GN	Version	
Order No.	8869660000	RIDERSERIES, LED module, Rated control voltage: 110...230 V UC,	
GTIN (EAN)	4032248614721	Plug-in connection	
Qty.	10 ST		

Protective varistor



Pluggable protective modules for the RIDERSERIES RCI / RCM relay sockets, with optional protective functions.

- With protective varistor
- For UC supply voltage

General ordering data

Type	RIM-I 4 110VUC VAR	Version	
Order No.	8869730000	RIDERSERIES, Protective varistor, Rated control voltage: 110 V UC,	
GTIN (EAN)	4032248606351	Plug-in connection	
Qty.	10 ST		

ESG 6/15



Guaranteed long service life: ESG

The multi-colour and multi-format labels have a strong adhesive layer to ensure the best possible adhesion to the underlying surface. Double laminated polyester makes the basic material very thin and yet extremely tear-resistant. Your benefits with MultiMark

- "Different materials for various requirements"
- Can be used with equipment from many manufacturers
- Device markers with a familiar design

RCI374S15

Weidmüller Interface GmbH & Co. KG

Klingenbergstraße 26
D-32758 Detmold
Germany

www.weidmueller.com

Accessories

General ordering data

Type	ESG 6/15 MM WS	Version	
Order No.	2619940000	ESG, Device markers, 6 x 15 mm, white	
GTIN (EAN)	4050118626148		
Qty.	3000 ST		

ESG 6/17



Guaranteed long service life: ESG

The multi-colour and multi-format labels have a strong adhesive layer to ensure the best possible adhesion to the underlying surface. Double laminated polyester makes the basic material very thin and yet extremely tear-resistant.

Your benefits with MultiMark

- "Different materials for various requirements"
- Can be used with equipment from many manufacturers
- Device markers with a familiar design

General ordering data

Type	ESG 6/17 MM WS	Version	
Order No.	2005100000	ESG, Device markers, 6 x 17 mm, white	
GTIN (EAN)	4050118390728		
Qty.	3000 ST		

Blank

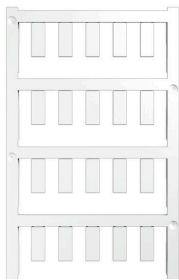

ESG is the tried-and-tested marker in MultiCard format for use on many well-known electrical devices. The result is high-quality device marking with a high-contrast appearance.

Various types are available for devices from manufacturers like Siemens, ABB, Beckhoff etc.

Advantages at a glance:

- Tags for universal usage, self-adhesive or clip-on tags, depending on type
- For aligned equipment, e.g. circuit breakers, we supply ESG markers for clipping onto tag rails
- Individual laser-quality printing according to specifications

For custom printing: Please send us a file of our labeling software M-Print PRO or M-Print PRO Online (without installation) for your labeling specifications.

General ordering data

Type	ESG 6/15 SRC-I MC NE WS	Version	
Order No.	2558350000	ESG, Device markers x 15 mm, PA 66, Colour: white, pluggable	
GTIN (EAN)	4050118569063		
Qty.	200 ST		

RCI374S15

Weidmüller Interface GmbH & Co. KG

Klingenbergstraße 26

D-32758 Detmold

Germany

Counterpart

www.weidmuller.com

Sockets

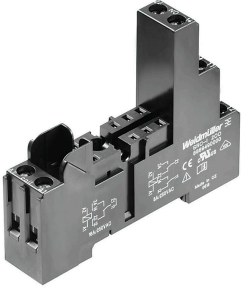

Relay sockets for the RIDERSERIES RCI relays

- 1 and 2 CO contacts
- Screw and PUSH IN connection
- Standard and low heights

General ordering data

Type	SRC-I 2CO	Version
Order No.	8869490000	RIDERSERIES RCI, Relay socket, Number of contacts: 2, CO contact,
GTIN (EAN)	4032248614448	Continuous current: 8 A, Screw connection
Qty.	10 ST	
Type	SRC-I 2CO N	Version
Order No.	8869480000	RIDERSERIES RCI, Relay socket, Number of contacts: 2, CO contact,
GTIN (EAN)	4032248614431	Continuous current: 8 A, Screw connection
Qty.	10 ST	
Type	SRC-I 2CO P	Version
Order No.	8869500000	RIDERSERIES RCI, Relay socket, Number of contacts: 2, CO contact,
GTIN (EAN)	4032248614455	Continuous current: 8 A, PUSH IN
Qty.	10 ST	