

RCL425110

Weidmüller Interface GmbH & Co. KG
Klingenbergstraße 26
D-32758 Detmold
Germany

www.weidmueller.com

Product image



Similar to illustration

Individual relays for TERMSERIES

- Electromechanical relays
- Different contact materials

General ordering data

Version	TERMSERIES, Relay, Number of contacts: 2, CO contact AgNi gold-plated, Rated control voltage: 110 V DC, Continuous current: 8 A, Plug-in connection, Test button available: No
Order No.	8828370000
Type	RCL425110
GTIN (EAN)	4032248531530
Qty.	20 items

RCL425110

Weidmüller Interface GmbH & Co. KG

Klingenbergstraße 26

D-32758 Detmold

Germany

www.weidmueller.com

Technical data

Approvals

Approvals



ROHS Conform

UL File Number Search [UL Website](#)

Certificate No. (cURus) E522350

Dimensions and weights

Depth	15.7 mm	Depth (inches)	0.6181 inch
Height	29 mm	Height (inches)	1.1417 inch
Width	12.7 mm	Width (inches)	0.5 inch
Net weight	13 g		

Temperatures

Storage temperature	-40 °C...85 °C	Ambient temperature	-40 °C...70 °C
Operating temperature		Humidity	40 °C / 93 % rel. humidity, no condensation

Environmental Product Compliance

RoHS Compliance Status	Compliant without exemption
REACH SVHC	No SVHC above 0.1 wt%

Rated data UL

Certificate No. (cURus)	E522350
-------------------------	---------

Control side

Rated control voltage	110 V DC	Rated current DC	4.1 mA
Power rating	420 mW	Coil resistance	28800 Ω ± 12 %
Status indicator	No		

Load side

Rated switching voltage	250 V AC	Continuous current	8 A
Max. switching frequency at rated load	0.1 Hz	Inrush current	15 A / 4 s
AC switching capacity (resistive), max.	2000 VA	DC switching capacity (resistive), max.	192 W @ 24 V
Switch-on delay	≤ 8 ms	Switch-off delay	≤ 6 ms
Contact type	2 CO contact (AgNi gold-plated)	Mechanical service life	30 x 106 switching cycles
Min. switching power	1 mA @ 1 V		

General data

Test button available	No	Mechanical switch position indicator	No
Colour	Transparent	UL 94 flammability rating	V-2

Insulation coordination

Rated voltage	250 V	Pollution severity	2
Surge voltage category	III	Insulating material group	IIIa

Creation date 18.02.2026 04:33:48 MEZ

Catalogue status / Drawings

RCL425110

Weidmüller Interface GmbH & Co. KG
 Klingenbergstraße 26
 D-32758 Detmold
 Germany

www.weidmueller.com

Technical data

Clearance and creepage distances for control side - load side	≥ 10 mm	Dielectric strength for control side - load side	5 kVeff / 1min
Dielectric strength of neighbouring contacts	2.5 kVeff / 1 Min.	Dielectric strength of open contact	1 kVeff / 1 min
Protection degree	IP20		

Further details of approvals / standards

Certificate No. (CSA)	249409-2426937	Certificate No. (VDE)	40020589
Certificate No. (cURus)	E522350		

Connection data

Wire connection method	Plug-in connection	Pitch in mm (P)	5.00 mm
------------------------	--------------------	-----------------	---------

Classifications

ETIM 8.0	EC001437	ETIM 9.0	EC001437
ETIM 10.0	EC001437	ECLASS 14.0	27-37-16-01
ECLASS 15.0	27-37-16-01		

Drawings

Wiring diagram



View of Pins from below

Graph

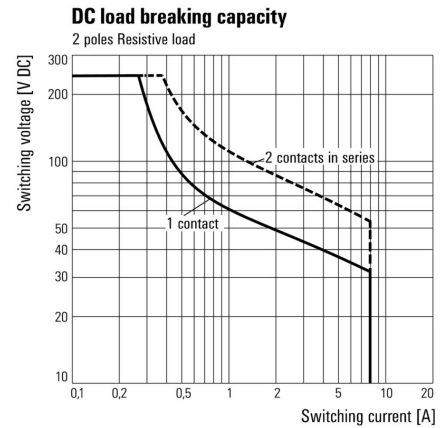

DC load limit curve Resistive load

Graph



Electrical service life 250 V AC resistive load



RCL425110

Weidmüller Interface GmbH & Co. KG
 Klingenbergstraße 26
 D-32758 Detmold
 Germany

Drawings

www.weidmueller.com

Miscellaneous

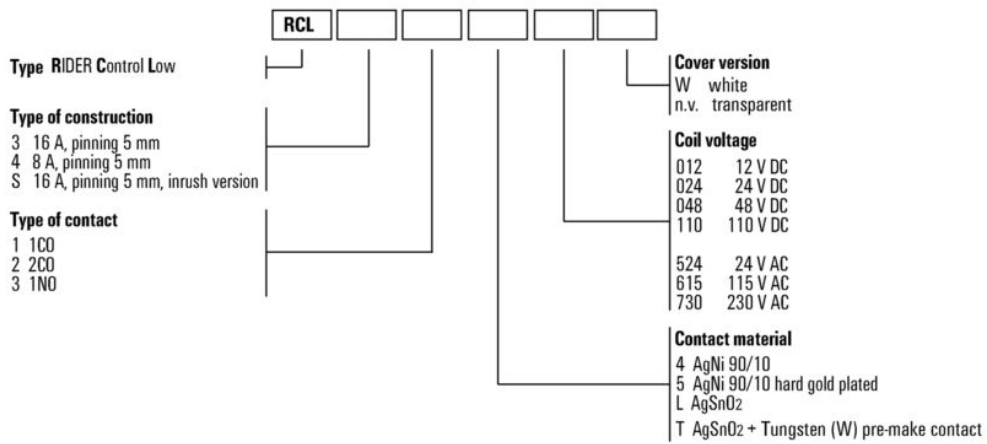

Type codes

RCL425110

Weidmüller Interface GmbH & Co. KG
 Klingenbergstraße 26
 D-32758 Detmold
 Germany

www.weidmueller.com

Accessories

Screw connection



TERMSERIES empty sockets with:

- 2 CO contacts
- Unique multi-voltage input from 24 to 230 V UC
- Input voltages from 5 V DC to 230 V UC with coloured marking: AC: red, DC: blue, UC: white
- Due to high-quality design and no sharp edges no risk of injuries during installation
- Partition plates for optical separation and reinforcement of insulation

General ordering data

Type	TRS 230VAC RC 2CO EMPTY	Version
Order No.	1124050000	TERMSERIES, Relay socket, Number of contacts: 2, CO contact, Rated
GTIN (EAN)	4032248905874	control voltage: 230 V AC \pm 10 %, Continuous current: 10 A, Screw
Qty.	10 ST	connection

Tension clamp connection



TERMSERIES empty sockets with:

- 2 CO contacts
- Unique multi-voltage input from 24 to 230 V UC
- Input voltages from 5 V DC to 230 V UC with coloured marking: AC: red, DC: blue, UC: white
- Due to high-quality design and no sharp edges no risk of injuries during installation
- Partition plates for optical separation and reinforcement of insulation

General ordering data

Type	TRZ 230VAC RC 2CO EMPTY	Version
Order No.	1124180000	TERMSERIES, Relay socket, Number of contacts: 2, CO contact, Rated
GTIN (EAN)	4032248906017	control voltage: 230 V AC \pm 10 %, Continuous current: 10 A, Tension-
Qty.	10 ST	clamp connection

PUSH IN connection

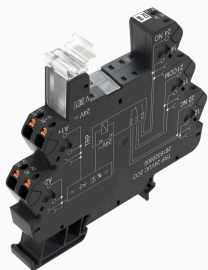

TERMSERIES empty sockets with:

- 2 CO contacts
- Unique multi-voltage input from 24 to 230 V UC
- Input voltages from 5 V DC to 230 V UC with coloured marking: AC: red, DC: blue, UC: white
- Due to high-quality design and no sharp edges no risk of injuries during installation
- Partition plates for optical separation and reinforcement of insulation

General ordering data

Type	TRP 230VAC RC 2CO EMPTY	Version
Order No.	2681190000	TERMSERIES, Relay socket, Number of contacts: 2, CO contact, Rated
GTIN (EAN)	4050118695441	control voltage: 230 V AC \pm 10 %, Continuous current: 10 A, PUSH IN
Qty.	10 ST	

RCL425110

Weidmüller Interface GmbH & Co. KG

Klingenbergstraße 26

D-32758 Detmold

Germany

Accessories

www.weidmueller.com

Screw connection

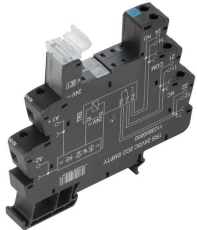

TERMSERIES empty sockets with:

- 2 CO contacts
- Unique multi-voltage input from 24 to 230 V UC
- Input voltages from 5 V DC to 230 V UC with coloured marking: AC: red, DC: blue, UC: white
- Due to high-quality design and no sharp edges no risk of injuries during installation
- Partition plates for optical separation and reinforcement of insulation

General ordering data

Type	TRS 230VUC 2CO EMPTY	Version	
Order No.	1124030000	TERMSERIES, Relay socket, Number of contacts: 2, CO contact, Rated	
GTIN (EAN)	4032248906222	control voltage: 230 V UC \pm 10%, Continuous current: 10 A, Screw	
Qty.	10 ST	connection	

Tension clamp connection

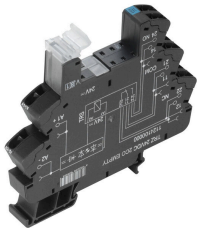

TERMSERIES empty sockets with:

- 2 CO contacts
- Unique multi-voltage input from 24 to 230 V UC
- Input voltages from 5 V DC to 230 V UC with coloured marking: AC: red, DC: blue, UC: white
- Due to high-quality design and no sharp edges no risk of injuries during installation
- Partition plates for optical separation and reinforcement of insulation

General ordering data

Type	TRZ 230VUC 2CO EMPTY	Version	
Order No.	1124150000	TERMSERIES, Relay socket, Number of contacts: 2, CO contact, Rated	
GTIN (EAN)	4032248905867	control voltage: 230 V UC \pm 10%, Continuous current: 10 A, Tension-	
Qty.	10 ST	clamp connection	

PUSH IN connection

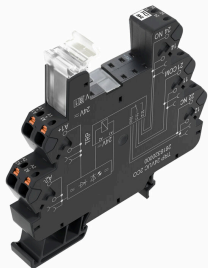

TERMSERIES empty sockets with:

- 2 CO contacts
- Unique multi-voltage input from 24 to 230 V UC
- Input voltages from 5 V DC to 230 V UC with coloured marking: AC: red, DC: blue, UC: white
- Due to high-quality design and no sharp edges no risk of injuries during installation
- Partition plates for optical separation and reinforcement of insulation

General ordering data

Type	TRP 230VUC 2CO EMPTY	Version	
Order No.	2681020000	TERMSERIES, Relay socket, Number of contacts: 2, CO contact, Rated	
GTIN (EAN)	4050118695427	control voltage: 230 V UC \pm 10%, Continuous current: 10 A, PUSH IN	
Qty.	10 ST		

RCL425110

Weidmüller Interface GmbH & Co. KG
 Klingenbergstraße 26
 D-32758 Detmold
 Germany

www.weidmueller.com

Accessories

Screw connection

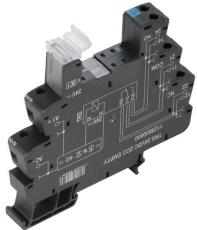

TERMSERIES empty sockets with:

- 2 CO contacts
- Unique multi-voltage input from 24 to 230 V UC
- Input voltages from 5 V DC to 230 V UC with coloured marking: AC: red, DC: blue, UC: white
- Due to high-quality design and no sharp edges no risk of injuries during installation
- Partition plates for optical separation and reinforcement of insulation

General ordering data

Type	TRS 120VAC RC 2CO EMPTY	Version
Order No.	1124040000	TERMSERIES, Relay socket, Number of contacts: 2, CO contact, Rated
GTIN (EAN)	4032248906178	control voltage: 120 V AC \pm 10 %, Continuous current: 10 A, Screw
Qty.	10 ST	connection

Tension clamp connection

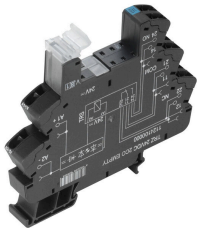

TERMSERIES empty sockets with:

- 2 CO contacts
- Unique multi-voltage input from 24 to 230 V UC
- Input voltages from 5 V DC to 230 V UC with coloured marking: AC: red, DC: blue, UC: white
- Due to high-quality design and no sharp edges no risk of injuries during installation
- Partition plates for optical separation and reinforcement of insulation

General ordering data

Type	TRZ 120VAC RC 2CO EMPTY	Version
Order No.	1124170000	TERMSERIES, Relay socket, Number of contacts: 2, CO contact, Rated
GTIN (EAN)	4032248905904	control voltage: 120 V AC \pm 10 %, Continuous current: 10 A, Tension-
Qty.	10 ST	clamp connection

PUSH IN connection

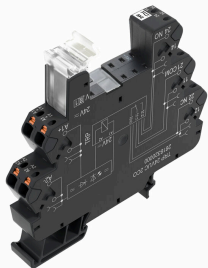

TERMSERIES empty sockets with:

- 2 CO contacts
- Unique multi-voltage input from 24 to 230 V UC
- Input voltages from 5 V DC to 230 V UC with coloured marking: AC: red, DC: blue, UC: white
- Due to high-quality design and no sharp edges no risk of injuries during installation
- Partition plates for optical separation and reinforcement of insulation

General ordering data

Type	TRP 120VAC RC 2CO EMPTY	Version
Order No.	2681030000	TERMSERIES, Relay socket, Number of contacts: 2, CO contact, Rated
GTIN (EAN)	4050118695434	control voltage: 120 V AC \pm 10 %, Continuous current: 10 A, PUSH IN
Qty.	10 ST	

RCL425110

Weidmüller Interface GmbH & Co. KG
 Klingenbergstraße 26
 D-32758 Detmold
 Germany

Accessories

www.weidmueller.com

Screw connection

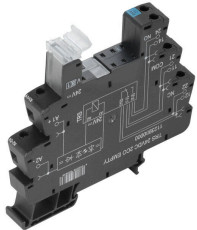

TERMSERIES empty sockets with:

- 2 CO contacts
- Unique multi-voltage input from 24 to 230 V UC
- Input voltages from 5 V DC to 230 V UC with coloured marking: AC: red, DC: blue, UC: white
- Due to high-quality design and no sharp edges no risk of injuries during installation
- Partition plates for optical separation and reinforcement of insulation

General ordering data

Type	TRS 120VUC 2CO EMPTY	Version	
Order No.	1124020000	TERMSERIES, Relay socket, Number of contacts: 2, CO contact, Rated control voltage: 120 V UC $\pm 10\%$, Continuous current: 10 A, Screw connection	
GTIN (EAN)	4032248905812		
Qty.	10 ST		

Tension clamp connection

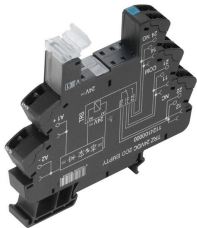

TERMSERIES empty sockets with:

- 2 CO contacts
- Unique multi-voltage input from 24 to 230 V UC
- Input voltages from 5 V DC to 230 V UC with coloured marking: AC: red, DC: blue, UC: white
- Due to high-quality design and no sharp edges no risk of injuries during installation
- Partition plates for optical separation and reinforcement of insulation

General ordering data

Type	TRZ 120VUC 2CO EMPTY	Version	
Order No.	1124140000	TERMSERIES, Relay socket, Number of contacts: 2, CO contact, Rated control voltage: 120 V UC $\pm 10\%$, Continuous current: 10 A, Tension-clamp connection	
GTIN (EAN)	4032248905928		
Qty.	10 ST		

PUSH IN connection

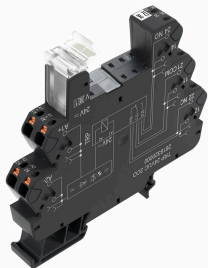

TERMSERIES empty sockets with:

- 2 CO contacts
- Unique multi-voltage input from 24 to 230 V UC
- Input voltages from 5 V DC to 230 V UC with coloured marking: AC: red, DC: blue, UC: white
- Due to high-quality design and no sharp edges no risk of injuries during installation
- Partition plates for optical separation and reinforcement of insulation

General ordering data

Type	TRP 120VUC 2CO EMPTY	Version	
Order No.	2681010000	TERMSERIES, Relay socket, Number of contacts: 2, CO contact, Rated control voltage: 120 V UC $\pm 10\%$, Continuous current: 10 A, PUSH IN	
GTIN (EAN)	4050118695410		
Qty.	10 ST		

RCL425110

Weidmüller Interface GmbH & Co. KG
 Klingenbergstraße 26
 D-32758 Detmold
 Germany

Counterpart

www.weidmueller.com

Screw connection

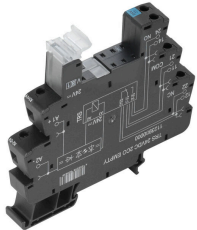

TERMSERIES empty sockets with:

- 2 CO contacts
- Unique multi-voltage input from 24 to 230 V UC
- Input voltages from 5 V DC to 230 V UC with coloured marking: AC: red, DC: blue, UC: white
- Due to high-quality design and no sharp edges no risk of injuries during installation
- Partition plates for optical separation and reinforcement of insulation

General ordering data

Type	TRS 230VUC 2CO EMPTY	Version
Order No.	1124030000	TERMSERIES, Relay socket, Number of contacts: 2, CO contact, Rated control voltage: 230 V UC $\pm 10\%$, Continuous current: 10 A, Screw connection
GTIN (EAN)	4032248906222	
Qty.	10 ST	
Type	TRS 230VAC RC 2CO EMPTY	Version
Order No.	1124050000	TERMSERIES, Relay socket, Number of contacts: 2, CO contact, Rated control voltage: 230 V AC $\pm 10\%$, Continuous current: 10 A, Screw connection
GTIN (EAN)	4032248905874	
Qty.	10 ST	
Type	TRS 120VUC 2CO EMPTY	Version
Order No.	1124020000	TERMSERIES, Relay socket, Number of contacts: 2, CO contact, Rated control voltage: 120 V UC $\pm 10\%$, Continuous current: 10 A, Screw connection
GTIN (EAN)	4032248905812	
Qty.	10 ST	
Type	TRS 120VAC RC 2CO EMPTY	Version
Order No.	1124040000	TERMSERIES, Relay socket, Number of contacts: 2, CO contact, Rated control voltage: 120 V AC $\pm 10\%$, Continuous current: 10 A, Screw connection
GTIN (EAN)	4032248906178	
Qty.	10 ST	

Tension clamp connection

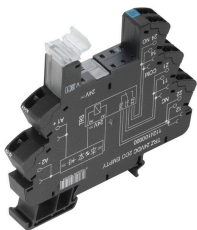

TERMSERIES empty sockets with:

- 2 CO contacts
- Unique multi-voltage input from 24 to 230 V UC
- Input voltages from 5 V DC to 230 V UC with coloured marking: AC: red, DC: blue, UC: white
- Due to high-quality design and no sharp edges no risk of injuries during installation
- Partition plates for optical separation and reinforcement of insulation

General ordering data

Type	TRZ 120VAC RC 2CO EMPTY	Version
Order No.	1124170000	TERMSERIES, Relay socket, Number of contacts: 2, CO contact, Rated control voltage: 120 V AC $\pm 10\%$, Continuous current: 10 A, Tension-clamp connection
GTIN (EAN)	4032248905904	
Qty.	10 ST	
Type	TRZ 120VUC 2CO EMPTY	Version
Order No.	1124140000	TERMSERIES, Relay socket, Number of contacts: 2, CO contact, Rated control voltage: 120 V UC $\pm 10\%$, Continuous current: 10 A, Tension-clamp connection
GTIN (EAN)	4032248905928	
Qty.	10 ST	

RCL425110

Weidmüller Interface GmbH & Co. KG
 Klingenbergstraße 26
 D-32758 Detmold
 Germany

www.weidmueller.com

Counterpart

Type	TRZ 230VUC 2CO EMPTY	Version
Order No.	1124150000	TERMSERIES, Relay socket, Number of contacts: 2, CO contact, Rated
GTIN (EAN)	4032248905867	control voltage: 230 V UC ±10%, Continuous current: 10 A, Tension-clamp connection
Qty.	10 ST	
Type	TRZ 230VAC RC 2CO EMPTY	Version
Order No.	1124180000	TERMSERIES, Relay socket, Number of contacts: 2, CO contact, Rated
GTIN (EAN)	4032248906017	control voltage: 230 V AC ±10 %, Continuous current: 10 A, Tension-clamp connection
Qty.	10 ST	

PUSH IN connection

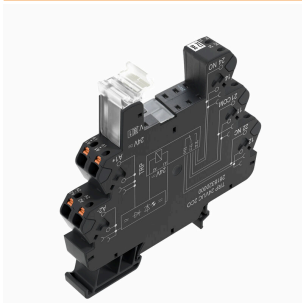

TERMSERIES empty sockets with:

- 2 CO contacts
- Unique multi-voltage input from 24 to 230 V UC
- Input voltages from 5 V DC to 230 V UC with coloured marking: AC: red, DC: blue, UC: white
- Due to high-quality design and no sharp edges no risk of injuries during installation
- Partition plates for optical separation and reinforcement of insulation

General ordering data

Type	TRP 230VUC 2CO EMPTY	Version
Order No.	2681020000	TERMSERIES, Relay socket, Number of contacts: 2, CO contact, Rated
GTIN (EAN)	4050118695427	control voltage: 230 V UC ±10%, Continuous current: 10 A, PUSH IN
Qty.	10 ST	
Type	TRP 230VAC RC 2CO EMPTY	Version
Order No.	2681190000	TERMSERIES, Relay socket, Number of contacts: 2, CO contact, Rated
GTIN (EAN)	4050118695441	control voltage: 230 V AC ±10 %, Continuous current: 10 A, PUSH IN
Qty.	10 ST	
Type	TRP 120VUC 2CO EMPTY	Version
Order No.	2681010000	TERMSERIES, Relay socket, Number of contacts: 2, CO contact, Rated
GTIN (EAN)	4050118695410	control voltage: 120 V UC ±10 %, Continuous current: 10 A, PUSH IN
Qty.	10 ST	
Type	TRP 120VAC RC 2CO EMPTY	Version
Order No.	2681030000	TERMSERIES, Relay socket, Number of contacts: 2, CO contact, Rated
GTIN (EAN)	4050118695434	control voltage: 120 V AC ±10 %, Continuous current: 10 A, PUSH IN
Qty.	10 ST	