

**TIMER BTM-S**

**Weidmüller Interface GmbH & Co. KG**  
 Klingenbergstraße 26  
 D-32758 Detmold  
 Germany

www.weidmueller.com

**Product image**

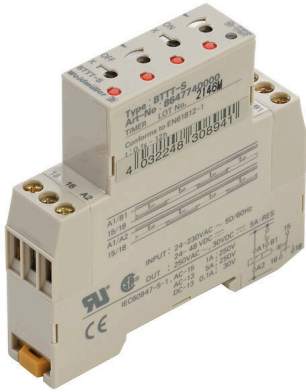

Similar to illustration

**General ordering data**

Version	BT-SERIES, Multifunction timing relay, with separate control input, , Number of contacts: 1, CO contact, AgNi 90/10, Rated control voltage: 24...230 V AC, 24...48 V DC, Continuous current: 5 A, Screw connection
Order No.	<a href="#">8647700000</a>
Type	TIMER BTM-S
GTIN (EAN)	4032248308903
Qty.	10 items
Delivery status	Discontinued
Available until	2021-12-31T00:00:00+01:00
Alternative product	<a href="#">TFIS 12-240VUC 1CO M7C</a>

## TIMER BTM-S

Weidmüller Interface GmbH &amp; Co. KG

Klingenbergstraße 26

D-32758 Detmold

Germany

www.weidmueller.com

## Technical data

## Approvals

Approvals



ROHS Conform

UL File Number Search [UL Website](#)

Certificate No. (cURus) E223474

## Dimensions and weights

Depth	74 mm	Depth (inches)	2.9134 inch
Height	80 mm	Height (inches)	3.1496 inch
Width	17.5 mm	Width (inches)	0.689 inch
Net weight	76.2 g		

## Temperatures

Storage temperature	-25 °C...65 °C	Operating temperature	-10 °C...55
Humidity	35...85 % rel. humidity, no condensation		

## Environmental Product Compliance

RoHS Compliance Status	Compliant
REACH SVHC	No SVHC above 0.1 wt%

## Rated data UL

Certificate No. (cURus) E223474

## Control side

Rated control voltage	24...230 V AC, 24...48 V DC	Power rating	≤ 0.4 VA, 1.6 W
Status indicator	LED green: supply voltage, LED orange: relay output on	Time ranges	0.1 s - 1.2 s, 1 s - 12 s, 0.1 min - 1.2 min, 1 min - 12 min, 0.1 h - 1.2 h, 1 h - 12 h, 10 h - 120 h
Setting tolerance	10 %	Max. reset time after voltage interruption	100 ms
Min. pulse duration	50 ms	Repeat accuracy	± 1 %

## Load side

Rated switching voltage	250 V AC	Continuous current	5 A
Max. switching voltage, AC	250 V	AC switching capacity (resistive), max.	2500 VA
DC switching capacity (resistive), max.	120 W @ 24 V	Contact type	1 CO contact (AgNi 90/10)
Electrical service life, DC coil	105 switching cycles (5A at 250 Vac, ohm load at 1800/h)	Mechanical service life	107 switching cycles (no load, 1800/h)

## General data

Version	with separate control input	Mounting rail	TS 35
Test button available	No	Mechanical switch position indicator	No
Colour	beige	UL 94 flammability rating	V-2

Creation date 18.02.2026 04:05:03 MEZ

Catalogue status / Drawings

## TIMER BTM-S

**Weidmüller Interface GmbH & Co. KG**  
 Klingenbergstraße 26  
 D-32758 Detmold  
 Germany

www.weidmueller.com

## Technical data

### Insulation coordination

Dielectric strength, Input/Output	2 kVeff / 1 min	Protection degree	IP20
-----------------------------------	-----------------	-------------------	------

### Further details of approvals / standards

Standards	UL508	Certificate No. (CSA)	219713
Certificate No. (cURus)	E223474		

### Connection data

Wire connection method	Screw connection	Stripping length, rated connection	7 mm
Tightening torque, max.	0.98 Nm	Clamping range, rated connection	1.5 mm <sup>2</sup>
Clamping range, min.	0.5 mm <sup>2</sup>	Clamping range, max.	2.5 mm <sup>2</sup>
Wire connection cross section AWG, min.	AWG 20	Wire connection cross section AWG, max.	AWG 14
Wire cross-section, solid, min.	0.5 mm <sup>2</sup>	Wire cross-section, solid, max.	2.5 mm <sup>2</sup>
Wire connection cross section, finely stranded, min.	0.5 mm <sup>2</sup>	Wire connection cross section, finely stranded, max.	2.5 mm <sup>2</sup>
Wire connection cross-section, finely stranded with wire-end ferrules DIN 46228/4, min.	0.5 mm <sup>2</sup>	Wire connection cross-section, finely stranded with wire-end ferrules DIN 46228/4, max.	2.5 mm <sup>2</sup>
Conductor cross-section, flexible, AEH (DIN 46228-1), min.	0.5 mm <sup>2</sup>	Conductor cross-section, flexible, AEH (DIN 46228-1), max.	2.5 mm <sup>2</sup>
Wire connection cross section, finely stranded, two clampable wires, min.	0.5 mm <sup>2</sup>	Wire cross-section, finely stranded, two clampable wires, max.	1.5 mm <sup>2</sup>
Blade size	size PH1		

### Classifications

ETIM 8.0	EC001439	ETIM 9.0	EC001439
ETIM 10.0	EC001439	ECLASS 14.0	27-37-16-05
ECLASS 15.0	27-37-16-05		

TIMER BTM-S

Weidmüller Interface GmbH & Co. KG  
 Klingenbergstraße 26  
 D-32758 Detmold  
 Germany

www.weidmueller.com

Drawings

Wiring diagram

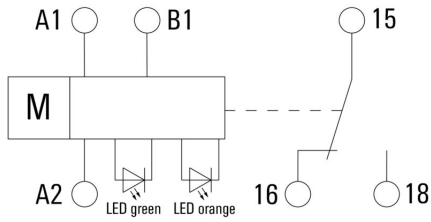

Dimensional drawing

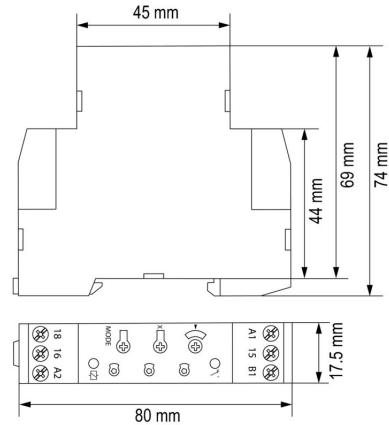

Example of use

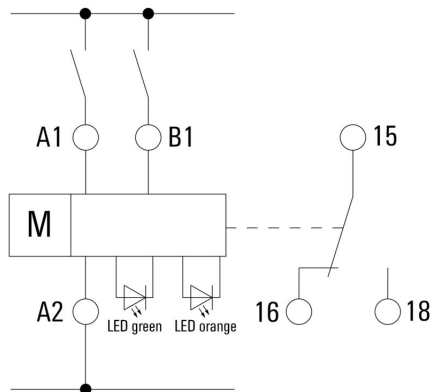

Wiring example

Dimensional drawing

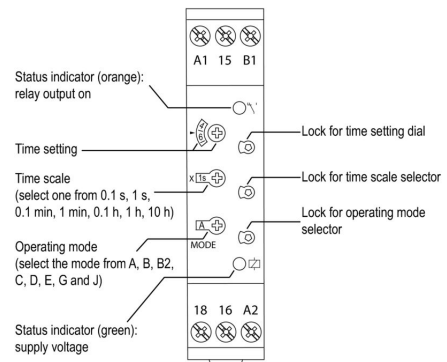

Detailed drawing

Graph

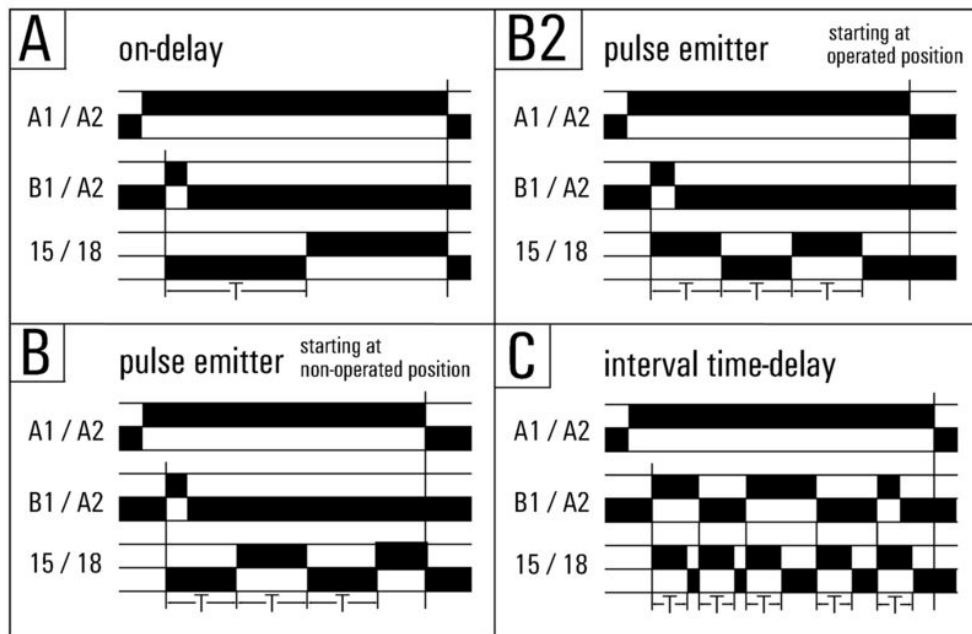

Time functions

Drawings

Graph

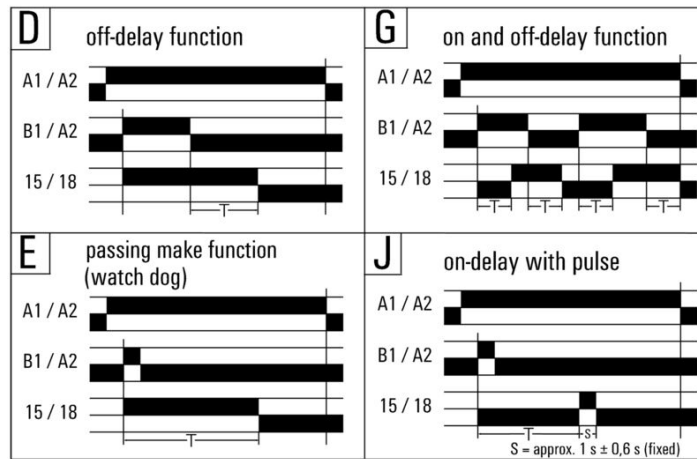

Time functions

## TIMER BTM-S

**Weidmüller Interface GmbH & Co. KG**  
 Klingenbergstraße 26  
 D-32758 Detmold  
 Germany

[www.weidmueller.com](http://www.weidmueller.com)

## Accessories

### Crosshead screwdriver Phillips



Crosshead screwdriver, Phillips, SDK PH DIN 5262, ISO 8764/2-PH, output to ISO 8764-PH, ChromTop tip, SoftFinish grip

#### General ordering data

Type	SDK PH1 X 80	Version	
Order No.	<a href="#">2749410000</a>	Screwdriver, Blade width (B): 4.5 mm, 80 mm, Blade thickness (A): 1	
GTIN (EAN)	4050118895636		
Qty.	1 ST		

Type	SDIK PH1 X 80	Version	
Order No.	<a href="#">2749890000</a>	Screwdriver, Blade width (B): 1 mm, 80 mm, Blade thickness (A): 1	
GTIN (EAN)	4050118897098		
Qty.	1 ST		

### Crosshead screwdriver, Phillips



VDE insulated screwdriver sets, for working on live parts up to 1000 V AC and 1500 V DC, DIN EN 60900. IEC 900. Each piece is "GS" safety tested. Blade made from fully hardened, high-alloy chromium-vanadium-molybdenum steel, gun-metal finish.

#### General ordering data

Type	SDIK SLIM PH1 X 80	Version	
Order No.	<a href="#">2749650000</a>	Screwdriver, Blade width (B): 1 mm, 80 mm, Blade thickness (A): 1	
GTIN (EAN)	4050118896398		
Qty.	1 ST		

## BT-SERIES

## TIMER BTM-S

**Weidmüller Interface GmbH & Co. KG**  
Klingenbergstraße 26  
D-32758 Detmold  
Germany

[www.weidmueller.com](http://www.weidmueller.com)

## Accessories

### General ordering data

Type	BT LOCK PEN	Version	
Order No.	<a href="#">8659840000</a>	BT-SERIES, Operating tool	
GTIN (EAN)	4032248322572		
Qty.	5 ST		