

MRZ 230Vac 1CO 5uAu

Weidmüller Interface GmbH & Co. KG
 Klingenbergstraße 26
 D-32758 Detmold
 Germany

www.weidmueller.com

Product image

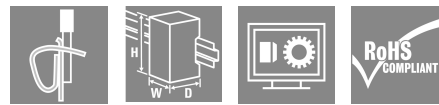
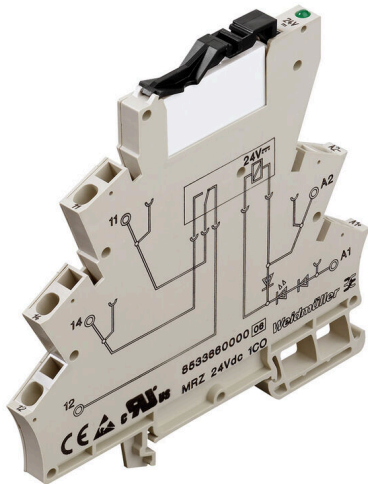

Similar to illustration

General ordering data

Version	MICROSERIES, Relay module, Number of contacts: 1, CO contact AgNi 5µm Au, Rated control voltage: 230 V AC ±10 %, Continuous current: 6 A, Tension-clamp connection, Test button available: No
Order No.	8596070000
Type	MRZ 230Vac 1CO 5uAu
GTIN (EAN)	4032248254965
Qty.	10 items
Delivery status	Discontinued
Available until	2016-06-30T00:00:00+02:00
Alternative product	TRZ 230VAC RC 1CO AU

MRZ 230Vac 1CO 5uAu

Weidmüller Interface GmbH & Co. KG

Klingenbergstraße 26

D-32758 Detmold

Germany

www.weidmueller.com

Technical data

Approvals

Approvals



ROHS Conform

UL File Number Search [UL Website](#)

Certificate no. (cULus) E141197

Dimensions and weights

Depth	94 mm	Depth (inches)	3.7008 inch
Height	94 mm	Height (inches)	3.7008 inch
Width	6.1 mm	Width (inches)	0.2402 inch
Length	94 mm	Length (inches)	3.7008 inch
Net weight	31.77 g		

Temperatures

Storage temperature	-40 °C...60 °C	Operating temperature	-25 °C...55
Humidity	40 °C / 93 % rel. humidity, no condensation		

Environmental Product Compliance

RoHS Compliance Status	Compliant
REACH SVHC	Lead 7439-92-1
SCIP	Of455e0d-3c4b-49b7-ae9b-28f18844bd32

Control side

Rated control voltage	230 V AC \pm 10 %	Rated current AC	7.6 mA
Power rating	1.75 VA, 210 mW	Status indicator	Green LED
Protective circuit	Rectifier		

Load side

Rated switching voltage	250 V AC	Max. switching frequency at rated load	0.1 Hz
Max. switching voltage, AC	250 V	Max. switching voltage, DC	250 V
Inrush current	6 A	AC switching capacity (resistive), max.	1500 VA
DC switching capacity (resistive), max.	144 W @ 24 V	Switch-on delay	< 13 ms
Switch-off delay	< 11 ms	Contact type	1 CO contact (AgNi 5µm Au)
Mechanical service life	5 x 10 ⁶ switching cycles	Min. switching power	1 mA @ 1 V

General data

Mounting rail	TS 35	Test button available	No
Mechanical switch position indicator	No	Colour	beige

Insulation coordination

Rated voltage	300 V	Pollution severity	2
Surge voltage category	III	Creepage and clearance distance input	\geq 5.5 mm
		output	

MRZ 230Vac 1CO 5uAu

Weidmüller Interface GmbH & Co. KG
 Klingenbergstraße 26
 D-32758 Detmold
 Germany

www.weidmueller.com

Technical data

Dielectric strength to mounting rail	4 kVeff / 1 Min.	Impulse withstand voltage	4 kV (1.2/50 µs)
Protection degree	IP20		

Further details of approvals / standards

Certificate no. (cULus)	E141197		
-------------------------	---------	--	--

Connection data

Wire connection method	Tension-clamp connection	Clamping range, rated connection	1.5 mm ²
Clamping range, min.	0.5 mm ²	Clamping range, max.	2.5 mm ²
Blade size	0.6 x 3.5 mm		

Classifications

ETIM 8.0	EC001437	ETIM 9.0	EC001437
ETIM 10.0	EC001437	ECLASS 14.0	27-37-16-01
ECLASS 15.0	27-37-16-01		

MRZ 230Vac 1CO 5uAu

Weidmüller Interface GmbH & Co. KG
 Klingenbergstraße 26
 D-32758 Detmold
 Germany

www.weidmueller.com

Drawings

Wiring diagram

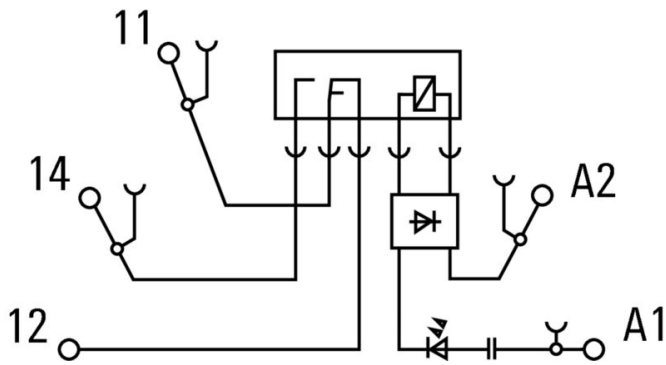

Graph



DC load limit curve

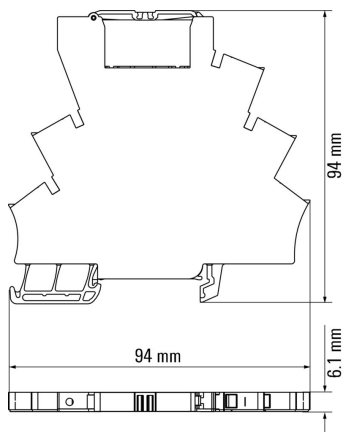
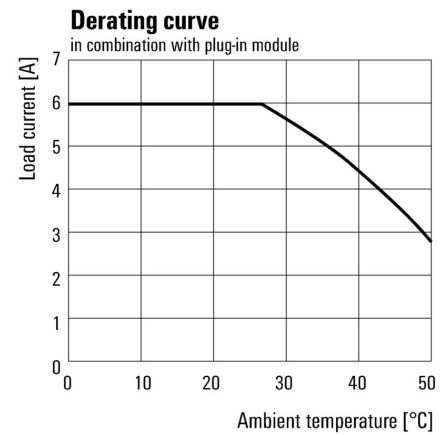
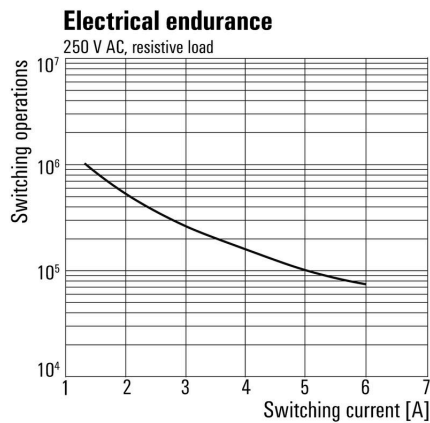

MRZ 230Vac 1CO 5uAu

Weidmüller Interface GmbH & Co. KG
 Klingenbergstraße 26
 D-32758 Detmold
 Germany

Accessories

www.weidmueller.com

Cross-connections



The distribution or multiplication of a potential to adjoining terminal blocks is realized via a cross-connection. Additional wiring effort can be easily avoided. Even if the poles are broken out, contact reliability in the terminal blocks is still ensured. Our portfolio offers pluggable and screwable cross-connection systems for modular terminal blocks.

General ordering data

Type	ZQV 4N/2 SW	Version
Order No.	1793970000	W-Series, Cross-connector, 32 A
GTIN (EAN)	4032248233762	
Qty.	60 ST	
Type	ZQV 4N/3 SW	Version
Order No.	1794000000	W-Series, Cross-connector, 32 A
GTIN (EAN)	4032248233793	
Qty.	60 ST	
Type	ZQV 4N/4 SW	Version
Order No.	1794030000	W-Series, Cross-connector, 32 A
GTIN (EAN)	4032248233915	
Qty.	60 ST	
Type	ZQV 4N/10 SW	Version
Order No.	1794060000	W-Series, Cross-connector, 32 A
GTIN (EAN)	4032248234059	
Qty.	20 ST	
Type	ZQV 4N/20 SW	Version
Order No.	1909120000	W-Series, Cross-connector, 32 A
GTIN (EAN)	4032248535804	
Qty.	20 ST	
Type	ZQV 4N/2 GE	Version
Order No.	1758250000	W-Series, Cross-connector, 32 A
GTIN (EAN)	4032248169795	
Qty.	60 ST	
Type	ZQV 4N/3 GE	Version
Order No.	1762630000	W-Series, Cross-connector, 32 A
GTIN (EAN)	4032248169788	
Qty.	60 ST	
Type	ZQV 4N/4 GE	Version
Order No.	1762620000	W-Series, Cross-connector, 32 A
GTIN (EAN)	4032248169771	
Qty.	60 ST	
Type	ZQV 4N/10 GE	Version
Order No.	1758260000	W-Series, Cross-connector, 32 A
GTIN (EAN)	4032248169764	
Qty.	20 ST	
Type	ZQV 4N/20 GE	Version
Order No.	1909020000	W-Series, Cross-connector, 32 A
GTIN (EAN)	4032248535644	
Qty.	20 ST	

MRZ 230Vac 1CO 5uAu

Weidmüller Interface GmbH & Co. KG
 Klingenbergstraße 26
 D-32758 Detmold
 Germany

www.weidmueller.com

Accessories

Type	ZQV 4N/2 BL	Version
Order No.	1793960000	W-Series, Cross-connector, 32 A
GTIN (EAN)	4032248233755	
Qty.	60 ST	
Type	ZQV 4N/3 BL	Version
Order No.	1793990000	W-Series, Cross-connector, 32 A
GTIN (EAN)	4032248233786	
Qty.	60 ST	
Type	ZQV 4N/4 BL	Version
Order No.	1794020000	W-Series, Cross-connector, 32 A
GTIN (EAN)	4032248233816	
Qty.	60 ST	
Type	ZQV 4N/10 BL	Version
Order No.	1794050000	W-Series, Cross-connector, 32 A
GTIN (EAN)	4032248234011	
Qty.	20 ST	
Type	ZQV 4N/20 BL	Version
Order No.	1909100000	W-Series, Cross-connector, 32 A
GTIN (EAN)	4032248535774	
Qty.	20 ST	
Type	ZQV 4N/2 RT	Version
Order No.	1793950000	W-Series, Cross-connector, 32 A
GTIN (EAN)	4032248233748	
Qty.	60 ST	
Type	ZQV 4N/3 RT	Version
Order No.	1793980000	W-Series, Cross-connector, 32 A
GTIN (EAN)	4032248233779	
Qty.	60 ST	
Type	ZQV 4N/4 RT	Version
Order No.	1794010000	W-Series, Cross-connector, 32 A
GTIN (EAN)	4032248233809	
Qty.	60 ST	
Type	ZQV 4N/10 RT	Version
Order No.	1794040000	W-Series, Cross-connector, 32 A
GTIN (EAN)	4032248234004	
Qty.	20 ST	
Type	ZQV 4N/20 RT	Version
Order No.	1909150000	W-Series, Cross-connector, 32 A
GTIN (EAN)	4032248535934	
Qty.	20 ST	

Slotted screwdriver



Slotted screwdriver with rounded blade SD DIN 5265,
 ISO 2380/2, output to DIN 5264, ISO 2380/1.
 ChromTop tip, SoftFinish grip

MRZ 230Vac 1CO 5uAu

Weidmüller Interface GmbH & Co. KG
Klingenbergstraße 26
D-32758 Detmold
Germany

www.weidmueller.com

Accessories

General ordering data

Type	SDS 0.6X3.5X100	Version	
Order No.	2749340000	Screwdriver, Blade width (B): 3.5 mm, Blade length: 100 mm, Blade thickness (A): 0.6 mm	
GTIN (EAN)	4050118895568		
Qty.	1 ST		

LM MT300 15X6

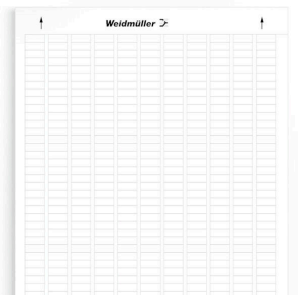

- Adhesive polyester labels
- Suitable for A4 laser printers
- Abrasion-resistant
- High heat resistance
- For marking all kinds of switchgear and modules
- Can also be written on with a ballpoint pen or STI marking pen

General ordering data

Type	LM MT300 15/6 WS	Version	
Order No.	1686361044	LaserMark, Device markers, 6 x 15.2 mm, white	
GTIN (EAN)	4008190493844		
Qty.	10 ST		

Blank



WS markers are the perfect match for the W-series connectors. Thanks to their system compatibility, the WS tags can also be used with the I-series and the Z-series. The large marking surfaces do not only permit long character strings but also multi-line text. WS markers are ideal for labels with long, customised character strings. Thanks to the proven MultiCard format, printing with PrintJet CONNECT oder/or Plotter is possible.

- Can be fitted in strips or individually
- Markers in proven MultiCard format

For custom printing: Please send us a file of our labeling software M-Print PRO or M-Print PRO Online (without installation) for your labeling specifications.

General ordering data

Type	WS 12/6 MC NE WS	Version	
Order No.	1609900000	WS, Terminal marker, 12 x 6 mm, Pitch in mm (P): 6.00 Weidmueller, Allen-Bradley, white	
GTIN (EAN)	4008190203467		
Qty.	600 ST		

Accessories

Micro interface digital



Specific adapter to be connected to the MICROSERIE RELAYS using a 10-pole flat-cable connector or 15-pole Sub-D connector.

General ordering data

Type	MI8DI-Z F10 S	Version
Order No.	8773530000	Plug-in connector in acc. with IEC60603-13 / DIN41651, Tension-clamp connection
GTIN (EAN)	4032248442065	
Qty.	1 ST	
Type	MI8DI-Z SUB D15S	Version
Order No.	8773490000	IEC 60603/DIN41612 plug-in connectors, Tension-clamp connection
GTIN (EAN)	4032248442010	
Qty.	1 ST	
Type	MI8DO-Z F10 S	Version
Order No.	8773620000	Plug-in connector in acc. with IEC60603-13 / DIN41651, Tension-clamp connection
GTIN (EAN)	4032248442157	
Qty.	1 ST	
Type	MI8DO-Z SUB D15S	Version
Order No.	8773570000	IEC 60603/DIN41612 plug-in connectors, Tension-clamp connection
GTIN (EAN)	4032248442102	
Qty.	1 ST	