

**DRI424012L**

**Weidmüller Interface GmbH & Co. KG**  
 Klingenbergstraße 26  
 D-32758 Detmold  
 Germany

www.weidmueller.com

**Product image**

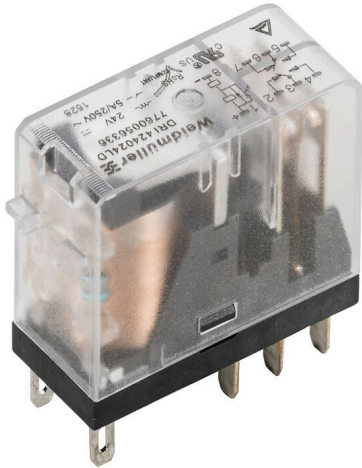

Similar to illustration

Individual relays within the D-SERIES DRI

- 2 CO contact
- Optional AC or DC coils
- With integrated status LED

**General ordering data**

Version	D-SERIES DRI, Relay, Number of contacts: 2, CO contact AgSnO, Rated control voltage: 12 V DC, Continuous current: 5 A, Flat blade connections (2.5 mm x 0.5 mm), Test button available: No
Order No.	<a href="#">7760056328</a>
Type	DRI4240 12L
GTIN (EAN)	6944 169740336
Qty.	20 items

## DRI424012L

Weidmüller Interface GmbH &amp; Co. KG

Klingenbergstraße 26

D-32758 Detmold

Germany

www.weidmueller.com

## Technical data

## Approvals

Approvals



ROHS Conform

UL File Number Search [UL Website](#)

Certificate No. (cURus) E312083

## Dimensions and weights

Depth	28 mm	Depth (inches)	1.1024 inch
Height	31 mm	Height (inches)	1.2205 inch
Width	13 mm	Width (inches)	0.5118 inch
Net weight	19 g		

## Temperatures

Storage temperature	-40 °C...85 °C	Ambient temperature	-40 °C...55 °C
Operating temperature		Humidity	35...85 % rel. humidity, no condensation

## Environmental Product Compliance

RoHS Compliance Status	Compliant without exemption
REACH SVHC	No SVHC above 0.1 wt%

## Rated data UL

Certificate No. (cURus)	E312083
-------------------------	---------

## Control side

Rated control voltage	12 V DC	Rated current DC	44,4 mA
Power rating	530 mW	Coil resistance	270 Ω ± 10 %
Status indicator	Green LED		

## Load side

Rated switching voltage	250 V AC	Continuous current	5 A
Max. switching frequency at rated load	0.1 Hz	Max. switching voltage, AC	250 V
Max. switching voltage, DC	250 V	AC switching capacity (resistive), max.	1250 VA
DC switching capacity (resistive), max.	150 W @ 24 V	Switch-on delay	≤ 15 ms
Switch-off delay	≤ 10 ms	Contact type	2 CO contact (AgSnO)
Mechanical service life	10 x 10 <sup>6</sup> switching cycles	Min. switching power	10 mA @ 24 V, 10 mA @ 12 V, 100 mA @ 5 V

## General data

Test button available	No		
Mechanical switch position indicator	No		
Colour	Transparent		
UL94 flammability rating component	Component	Relay cover	
	UL94 flammability rating	V-2	
	Component	Relay baseplate	
	UL94 flammability rating	V-0	

## DRI424012L

**Weidmüller Interface GmbH & Co. KG**

Klingenbergstraße 26  
D-32758 Detmold  
Germany

[www.weidmueller.com](http://www.weidmueller.com)

## Technical data

### Insulation coordination

Rated voltage	300 V	Pollution severity	2
Surge voltage category	III	Insulating material group	IIIa
Clearance and creepage distances for control side - load side	≥ 4 mm	Dielectric strength for control side - load side	5 kVeff / 1 min
Dielectric strength of neighbouring contacts	1.5 kVeff / 1 min.	Dielectric strength of open contact	1 kVeff / 1 min
Impulse withstand voltage	5 kV (1.2/50 µs)	Protection degree	IP20

### Further details of approvals / standards

Certificate No. (cURus)	E312083
-------------------------	---------

### Connection data

Wire connection method	Flat blade connections (2.5 mm x 0.5 mm)
------------------------	---

### Classifications

ETIM 8.0	EC001437	ETIM 9.0	EC001437
ETIM 10.0	EC001437	ECLASS 14.0	27-37-16-01
ECLASS 15.0	27-37-16-01		

Wiring diagram

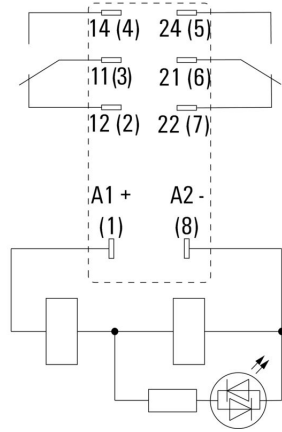

View of Pins from below

Graph

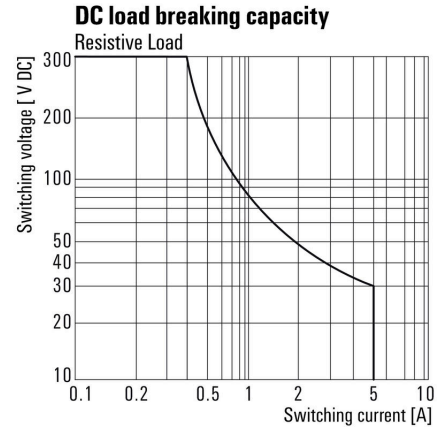

DC load limit curve Resistive load

Graph

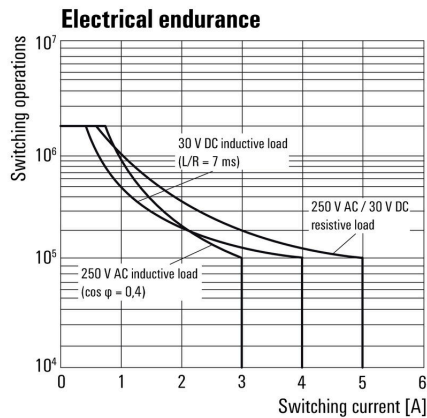

Electrical service life

Graph

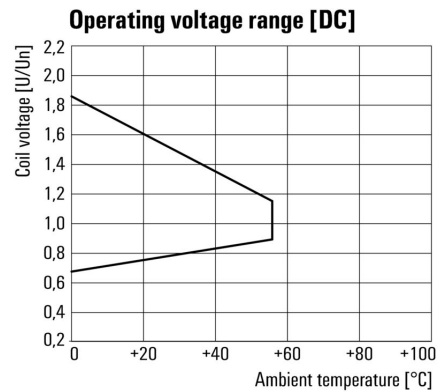

DC operational voltage range

Dimensional drawing

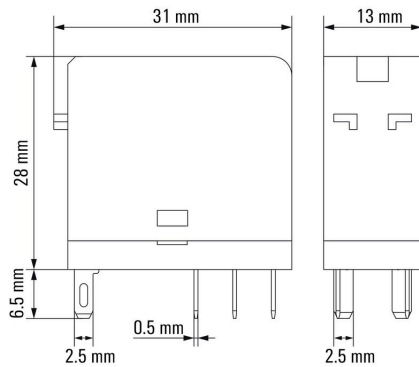

**DRI424012L**

**Weidmüller Interface GmbH & Co. KG**  
 Klingenbergstraße 26  
 D-32758 Detmold  
 Germany

**Drawings**

www.weidmueller.com

**Miscellaneous**

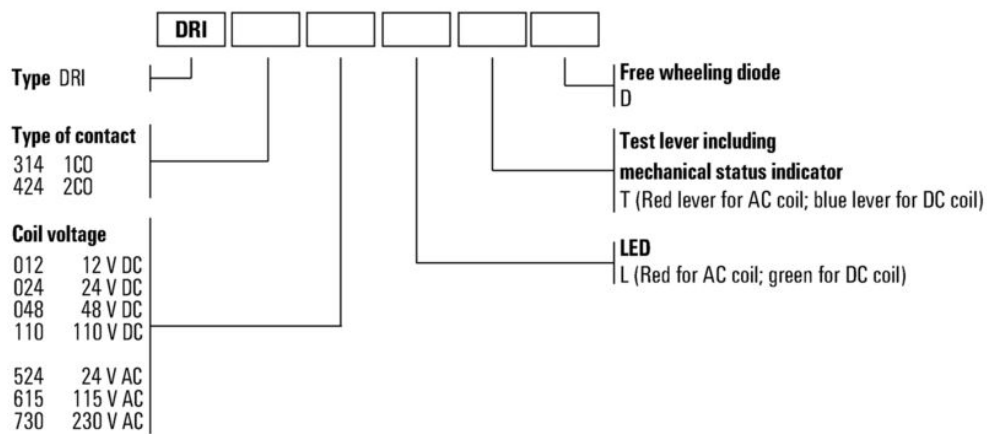

Type codes