

ACT20P-VMR-3PH-ILP-H-P

Weidmüller Interface GmbH & Co. KG
Klingenbergstraße 26
D-32758 Detmold
Germany

www.weidmueller.com



ACT20P: The flexible solution

- Precise and highly functional signal converters
- Release levers simplify handling

General ordering data

Version	Limit value monitoring, Input : 3 phase, Output : 2 x relays
Order No.	7760054361
Type	ACT20P-VMR-3PH-ILP-H-P
GTIN (EAN)	4050118559750
Qty.	1 items

ACT20P-VMR-3PH-ILP-H-P

Weidmüller Interface GmbH & Co. KG
 Klingenbergstraße 26
 D-32758 Detmold
 Germany

www.weidmueller.com

Technical data

Approvals

Approvals



ROHS Conform

UL File Number Search [UL Website](#)

Certificate No. (cURus) E469563

Dimensions and weights

Depth	114.3 mm	Depth (inches)	4.5 inch
Height	117 mm	Height (inches)	4.6063 inch
Width	22.5 mm	Width (inches)	0.8858 inch
Net weight	140 g		

Temperatures

Storage temperature	-40 °C...85 °C	Operating temperature	-20 °C...60 °C
Humidity at operating temperature	0...95 % (no condensation)	Humidity	5...85 % rel. humidity, no condensation

Probability of failure

SIL in compliance with IEC 61508 None

Environmental Product Compliance

RoHS Compliance Status	Compliant with exemption
RoHS Exemption (if applicable/known)	7a, 7cl
REACH SVHC	Lead 7439-92-1
SCIP	2f6dd957-421a-46db-a0c2-cf1609156924

Input

Number inputs	1	Type	3-phase or 3-phase plus zero conductor, AC voltage
Input voltage	180...500 VAC	Input resistance, voltage	≥1,8MΩ

Output

Number of outputs 2

Output (digital)

Rated switching current	5 A	Number of digital outputs	2
Max. switching voltage, AC	250 V	Max. switching voltage, DC	30 V
Hysteresis	5 % @ Phase asymmetry	Type	2 x 1 - or 1 x 2 changeover contact relay, Relay polarity can be inverted
Switch-on delay	0...10 s, configurable	Alarm function	Top and bottom limit values, window range, Holding function can be activated, Phase error, Phase sequence, Asymmetry, Alarm delay: 0...10 s

ACT20P-VMR-3PH-ILP-H-P

Weidmüller Interface GmbH & Co. KG

Klingenbergstraße 26
D-32758 Detmold
Germany

www.weidmueller.com

Technical data

Switching thresholds	Adjustable, MIN = 50... 100 % x URated input voltage (undervoltage alarm), MAX = 70...120 % x URated input voltage (overvoltage alarm)
----------------------	---

General data

Repeat accuracy	2 % *URated voltage	Accuracy	3 % *URated voltage
Protection degree	IP20	Supply voltage	supplied from voltage measurement inputs
Long-term drift	0.1 % / 10.000 h	Step response time	≤ 100 ms
Mounting rail	TS 35	Power consumption	≤ 3VA, <2 W
Temperature coefficient	350 ppm/K	Nominal power consumption	1.5 VA
Configuration	DIP switch and potentiometer	Operating altitude	≤ 2000 m

Insulation coordination

Impulse withstand voltage	6 kV (input - output), 4 kV (output 1- output 2), 1.2/50 µs	EMC standards	EN 61326-1
Test voltage	0.5 kV	Surge voltage category	III
Pollution severity	2	Galvanic isolation	between input / output / supply / relay
Insulation voltage	2.5 kV (input / output)	Rated voltage	600 VAC (input - output), 300 VAC (output 1 - output 2)

Connection data

Type of connection	PUSH IN	Tightening torque, min.	0.4 Nm
Tightening torque, max.	0.6 Nm	Clamping range, rated connection	2.5 mm ²
Clamping range, min.	0.5 mm ²	Clamping range, max.	2.5 mm ²
Wire connection cross section AWG, min.	AWG 26	Wire connection cross section AWG, max.	AWG 14

Part description

Product description	ACT20P-VMR-3PH-ILP-H is a three-phase voltage setpoint limit monitor relay (3-phase or 3-phase plus zero conductor). The device is powered by the input measuring circuit. The device incorporates two separate relay outputs which trigger an alarm upon phase asymmetry, phase loss, phase sequence errors and phase angle errors and when exceeding or falling below preset voltage limit values. The alarm can also be set to trigger after an adjustable time delay. Features <ul style="list-style-type: none"> • Supply from the input measuring circuit • Manual front-sided configuration via DIP switch, potentiometer and rotary switch • Various alarm functions: phase asymmetry, phase loss, phase sequence errors, phase angle errors, alarm delay, upper/lower limit value alarm, window alarm • Front LEDs indicates operation status and malfunction. • 3-way galvanic isolation between input, output 1 and output 2.
---------------------	--

Classifications

ETIM 8.0	EC002654	ETIM 9.0	EC002654
ETIM 10.0	EC002654	ECLASS 14.0	27-21-01-22
ECLASS 15.0	27-21-01-22		

ACT20P-VMR-3PH-ILP-H-P

Weidmüller Interface GmbH & Co. KG
 Klingenbergstraße 26
 D-32758 Detmold
 Germany

www.weidmueller.com

Drawings

Connection diagram

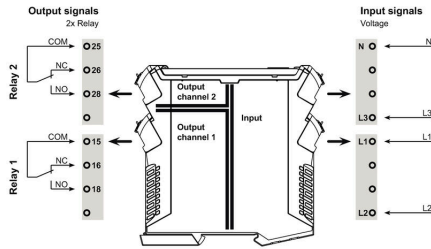

Dimensioned drawing

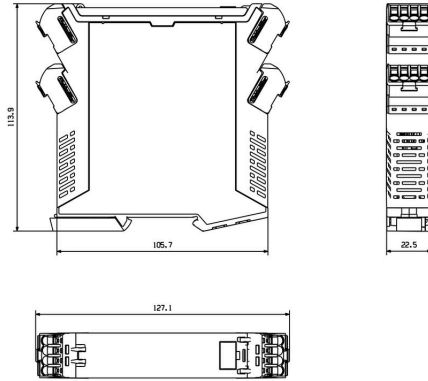

Overvoltage alarm (O)

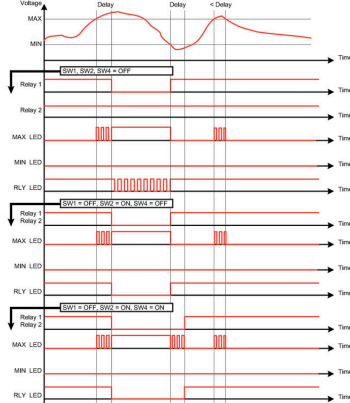

Undervoltage alarm (U)

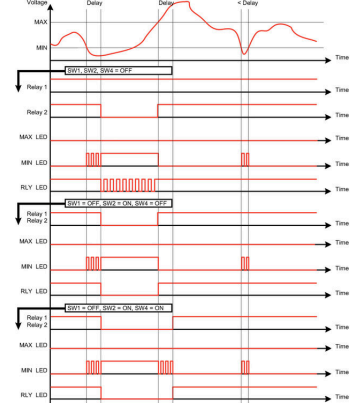

Window alarm (W)

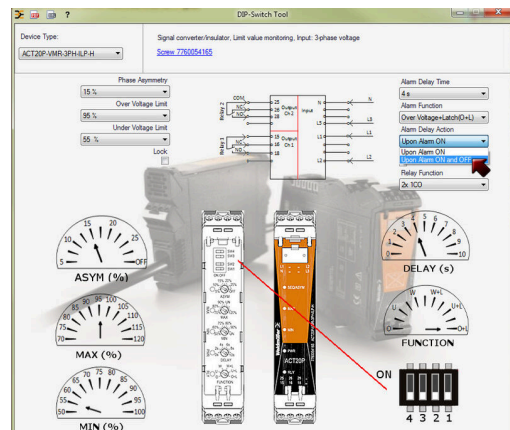
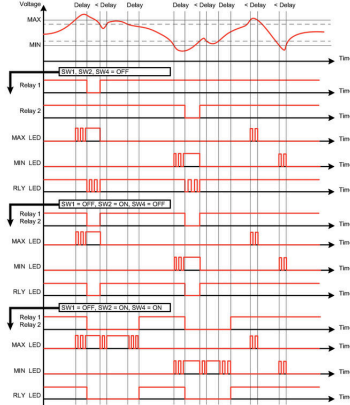

example for DIP switch setting (with ACT20 tool)

ACT20P-VMR-3PH-ILP-H-P

Weidmüller Interface GmbH & Co. KG
Klingenbergstraße 26
D-32758 Detmold
Germany

Drawings

www.weidmueller.com

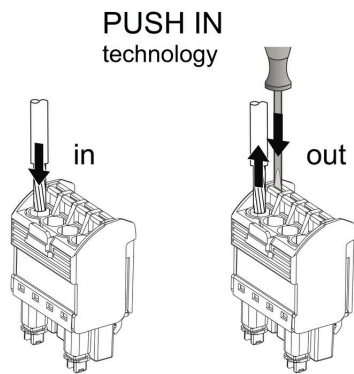

ACT20P-VMR-3PH-ILP-H-P

Weidmüller Interface GmbH & Co. KG

Klingenbergstraße 26
D-32758 Detmold
Germany

www.weidmueller.com

Accessories

Blank

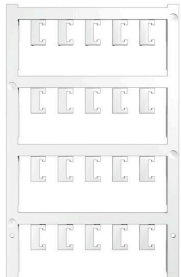

ESG is the tried-and-tested marker in MultiCard format for use on many well-known electrical devices. The result is high-quality device marking with a high-contrast appearance.

Various types are available for devices from manufacturers like Siemens, ABB, Beckhoff etc.

Advantages at a glance:

- Tags for universal usage, self-adhesive or clip-on tags, depending on type
- For aligned equipment, e.g. circuit breakers, we supply ESG markers for clipping onto tag rails
- Individual laser-quality printing according to specifications

For custom printing: Please send us a file of our labeling software M-Print PRO or M-Print PRO Online (without installation) for your labeling specifications.

General ordering data

Type	ESG 6.6/20 BHZ 5.00/04	Version	
Order No.	1082540000		ESG, Device markers x 20 mm, PA 66, Colour: white, pluggable
GTIN (EAN)	4032248845439		
Qty.	200 ST		
Type	ESG 8/13.5/43.3 SAI AU	Version	
Order No.	1912130000		ESG, Device markers x 13.5 mm, PA 66, Colour: Transparent, pluggable
GTIN (EAN)	4032248541164		
Qty.	5 ST		