

**RSS112024****Weidmüller Interface GmbH & Co. KG**Klingenbergstraße 26  
D-32758 Detmold  
Germany

www.weidmueller.com

**Product image**

Similar to illustration

Individual relays for TERMSERIES

- Electromechanical relays
- Different contact materials

**General ordering data**

Version	TERMSERIES, Relay, Number of contacts: 1, CO contact AgNi gold-plated, Rated control voltage: 24 V DC, Continuous current: 6 A, Plug-in connection, Test button available: No
Order No.	<a href="#">4061590000</a>
Type	RSS112024
GTIN (EAN)	4032248252282
Qty.	20 items

## Technical data

## Approvals

Approvals



ROHS Conform

UL File Number Search [UL Website](#)

Certificate No. (cURus) E351070

## Dimensions and weights

Depth	15 mm	Depth (inches)	0.5906 inch
Height	28 mm	Height (inches)	1.1024 inch
Width	5 mm	Width (inches)	0.1968 inch
Net weight	4.5 g		

## Temperatures

Storage temperature	-40 °C...85 °C	Ambient temperature	-40 °C...85 °C
Operating temperature		Humidity	5...85 % rel. humidity, no condensation

## Environmental Product Compliance

RoHS Compliance Status	Compliant without exemption
REACH SVHC	No SVHC above 0.1 wt%

## Rated data UL

Certificate No. (cURus)	E351070
-------------------------	---------

## Control side

Rated control voltage	24 V DC	Rated current DC	7 mA
Power rating	170 mW	Coil resistance	3388 Ω ± 10 %
Status indicator	No		

## Load side

Rated switching voltage	250 V AC	Max. switching frequency at rated load	0.1 Hz
Max. switching voltage, AC	250 V	Max. switching voltage, DC	250 V
AC switching capacity (resistive), max.	1500 VA	DC switching capacity (resistive), max.	144 W @ 24 V
Switch-on delay	<8 ms	Switch-off delay	<4 ms
Contact type	1 CO contact (AgNi gold-plated)	Mechanical service life	5 x 10 <sup>6</sup> switching cycles
Min. switching power	1 mA @ 1 V		

## General data

Test button available	No	Mechanical switch position indicator	No
Colour	white	UL 94 flammability rating	V-0

**Technical data****Insulation coordination**

Clearance and creepage distances for control side - load side	≥ 6 mm	Dielectric strength for control side - load side	4 kVeff / 1 Min.
Dielectric strength of open contact	1 kVeff / 1 min	Protection degree	IP67

**Further details of approvals / standards**

Certificate No. (VDE)	40029391	Certificate No. (cURus)	E351070
-----------------------	----------	-------------------------	---------

**Connection data**

Wire connection method	Plug-in connection
------------------------	--------------------

**Classifications**

ETIM 8.0	EC001437	ETIM 9.0	EC001437
ETIM 10.0	EC001437	ECLASS 14.0	27-37-16-01
ECLASS 15.0	27-37-16-01		

Wiring diagram



View of Pins from below

Graph

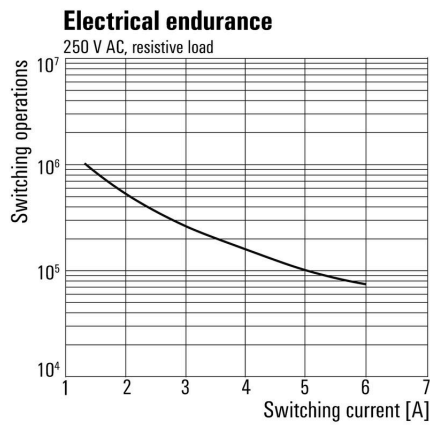

Electrical service life 230 V AC resistive load

Dimensional drawing

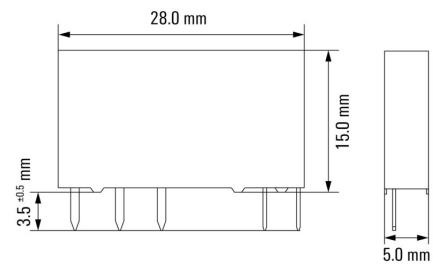

Miscellaneous

**Type code electromechanical relay (TERMSERIES)**



Type codes

## RSS112024

Weidmüller Interface GmbH &amp; Co. KG

Klingenbergstraße 26

D-32758 Detmold

Germany

www.weidmueller.com

## Accessories

## Screw connection



TERMSERIES empty sockets with:

- 1 CO contact
- Unique multi-voltage input from 24 to 230 V UC
- Input voltages with coloured marking: DC: blue, UC: white
- Due to high-quality design and no sharp edges no risk of injuries during installation
- Partition plates for optical separation and reinforcement of insulation

## General ordering data

Type	TRS 24VDC 1CO EMPTY	Version	
Order No.	<a href="#">1123240000</a>	TERMSERIES, Relay socket, Number of contacts: 1, CO contact, Rated control voltage: 24 V DC $\pm$ 20 %, Continuous current: 10 A, Screw connection	
GTIN (EAN)	4032248905485		
Qty.	10 ST		

## Tension clamp connection

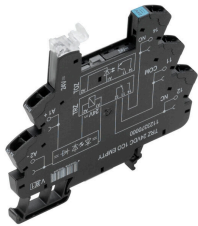

TERMSERIES empty sockets with:

- 1 CO contact
- Unique multi-voltage input from 24 to 230 V UC
- Input voltages with coloured marking: DC: blue, UC: white
- Due to high-quality design and no sharp edges no risk of injuries during installation
- Partition plates for optical separation and reinforcement of insulation

## General ordering data

Type	TRZ 24VDC 1CO EMPTY	Version	
Order No.	<a href="#">1123370000</a>	TERMSERIES, Relay socket, Number of contacts: 1, CO contact, Rated control voltage: 24 V DC $\pm$ 20 %, Continuous current: 10 A, Tension-clamp connection	
GTIN (EAN)	4032248905324		
Qty.	10 ST		

## PUSH IN connection

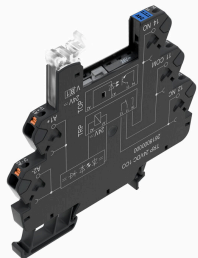

TERMSERIES empty sockets with:

- 1 CO contact
- Unique multi-voltage input from 24 to 230 V UC
- Input voltages with coloured marking: DC: blue, UC: white
- Due to high-quality design and no sharp edges no risk of injuries during installation
- Partition plates for optical separation and reinforcement of insulation

## General ordering data

Type	TRP 24VDC 1CO EMPTY	Version	
Order No.	<a href="#">2618870000</a>	TERMSERIES, Relay socket, Number of contacts: 1, CO contact, Rated control voltage: 24 V DC $\pm$ 20 %, Continuous current: 10 A, PUSH IN	
GTIN (EAN)	4050118669961		
Qty.	10 ST		

## RSS112024

Weidmüller Interface GmbH &amp; Co. KG

Klingenbergstraße 26

D-32758 Detmold

Germany

www.weidmueller.com

## Accessories

## Screw connection

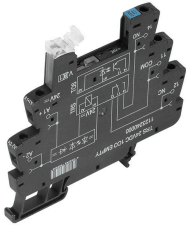

TERMSERIES empty sockets with:

- 1 CO contact
- Unique multi-voltage input from 24 to 230 V UC
- Input voltages with coloured marking: DC: blue, UC: white
- Due to high-quality design and no sharp edges no risk of injuries during installation
- Partition plates for optical separation and reinforcement of insulation

## General ordering data

Type	TRS 24VUC 1CO EMPTY	Version	
Order No.	<a href="#">1123250000</a>	TERMSERIES, Relay socket, Number of contacts: 1, CO contact, Rated control voltage: 24 V UC $\pm 10\%$ , Continuous current: 10 A, Screw connection	
GTIN (EAN)	4032248905713		
Qty.	10 ST		

## Tension clamp connection

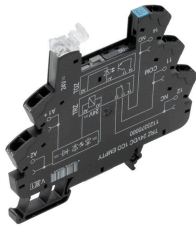

TERMSERIES empty sockets with:

- 1 CO contact
- Unique multi-voltage input from 24 to 230 V UC
- Input voltages with coloured marking: DC: blue, UC: white
- Due to high-quality design and no sharp edges no risk of injuries during installation
- Partition plates for optical separation and reinforcement of insulation

## General ordering data

Type	TRZ 24VUC 1CO EMPTY	Version	
Order No.	<a href="#">1123380000</a>	TERMSERIES, Relay socket, Number of contacts: 1, CO contact, Rated control voltage: 24 V UC $\pm 10\%$ , Continuous current: 10 A, Tension-clamp connection	
GTIN (EAN)	4032248905195		
Qty.	10 ST		

## PUSH IN connection

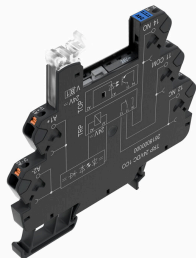

TERMSERIES empty sockets with:

- 1 CO contact
- Unique multi-voltage input from 24 to 230 V UC
- Input voltages with coloured marking: DC: blue, UC: white
- Due to high-quality design and no sharp edges no risk of injuries during installation
- Partition plates for optical separation and reinforcement of insulation

## General ordering data

Type	TRP 24VUC 1CO EMPTY	Version	
Order No.	<a href="#">2618910000</a>	TERMSERIES, Relay socket, Number of contacts: 1, CO contact, Rated control voltage: 24 V UC $\pm 10\%$ , Continuous current: 10 A, PUSH IN	
GTIN (EAN)	4050118669923		
Qty.	10 ST		

## RSS112024

Weidmüller Interface GmbH &amp; Co. KG

Klingenbergstraße 26

D-32758 Detmold

Germany

www.weidmueller.com

## Accessories

## Screw connection

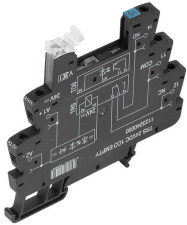

TERMSERIES empty sockets with:

- 1 CO contact
- Unique multi-voltage input from 24 to 230 V UC
- Input voltages with coloured marking: DC: blue, UC: white
- Due to high-quality design and no sharp edges no risk of injuries during installation
- Partition plates for optical separation and reinforcement of insulation

## General ordering data

Type	TRS 48VUC 1CO EMPTY	Version	
Order No.	<a href="#">1123270000</a>	TERMSERIES, Relay socket, Number of contacts: 1, CO contact, Rated control voltage: 48 V UC $\pm 10\%$ , Continuous current: 10 A, Screw connection	
GTIN (EAN)	4032248905423		
Qty.	10 ST		

## Tension clamp connection

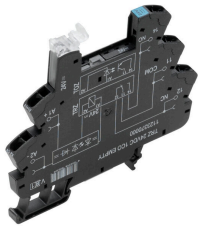

TERMSERIES empty sockets with:

- 1 CO contact
- Unique multi-voltage input from 24 to 230 V UC
- Input voltages with coloured marking: DC: blue, UC: white
- Due to high-quality design and no sharp edges no risk of injuries during installation
- Partition plates for optical separation and reinforcement of insulation

## General ordering data

Type	TRZ 48VUC 1CO EMPTY	Version	
Order No.	<a href="#">1123390000</a>	TERMSERIES, Relay socket, Number of contacts: 1, CO contact, Rated control voltage: 48 V UC $\pm 10\%$ , Continuous current: 10 A, Tension-clamp connection	
GTIN (EAN)	4032248905331		
Qty.	10 ST		

## PUSH IN connection

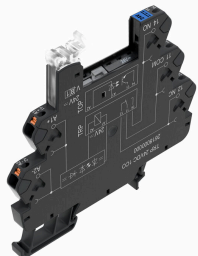

TERMSERIES empty sockets with:

- 1 CO contact
- Unique multi-voltage input from 24 to 230 V UC
- Input voltages with coloured marking: DC: blue, UC: white
- Due to high-quality design and no sharp edges no risk of injuries during installation
- Partition plates for optical separation and reinforcement of insulation

## General ordering data

Type	TRP 48VUC 1CO EMPTY	Version	
Order No.	<a href="#">2618920000</a>	TERMSERIES, Relay socket, Number of contacts: 1, CO contact, Rated control voltage: 48 V UC $\pm 10\%$ , Continuous current: 10 A, PUSH IN	
GTIN (EAN)	4050118669916		
Qty.	10 ST		

## RSS112024

Weidmüller Interface GmbH &amp; Co. KG

Klingenbergstraße 26

D-32758 Detmold

Germany

www.weidmueller.com

## Accessories

## Screw connection

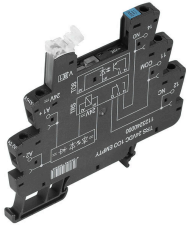

TERMSERIES empty sockets with:

- 1 CO contact
- Unique multi-voltage input from 24 to 230 V UC
- Input voltages with coloured marking: DC: blue, UC: white
- Due to high-quality design and no sharp edges no risk of injuries during installation
- Partition plates for optical separation and reinforcement of insulation

## General ordering data

Type	TRS 24-230VUC 1CO EMPTY	Version	
Order No.	<a href="#">1123330000</a>	TERMSERIES, Relay socket, Number of contacts: 1, CO contact, Rated	
GTIN (EAN)	4032248905614	control voltage: 24...230 V UC $\pm 10\%$ , Continuous current: 10 A,	
Qty.	10 ST	Screw connection	

## Tension clamp connection

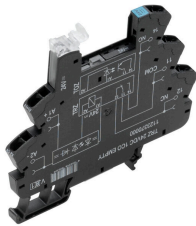

TERMSERIES empty sockets with:

- 1 CO contact
- Unique multi-voltage input from 24 to 230 V UC
- Input voltages with coloured marking: DC: blue, UC: white
- Due to high-quality design and no sharp edges no risk of injuries during installation
- Partition plates for optical separation and reinforcement of insulation

## General ordering data

Type	TRZ 24-230VUC 1CO EMPTY	Version	
Order No.	<a href="#">1123450000</a>	TERMSERIES, Relay socket, Number of contacts: 1, CO contact, Rated	
GTIN (EAN)	4032248905508	control voltage: 24...230 V UC $\pm 10\%$ , Continuous current: 10 A,	
Qty.	10 ST	Tension-clamp connection	

## PUSH IN connection

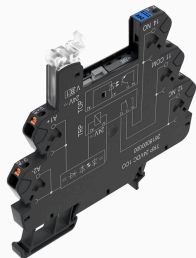

TERMSERIES empty sockets with:

- 1 CO contact
- Unique multi-voltage input from 24 to 230 V UC
- Input voltages with coloured marking: DC: blue, UC: white
- Due to high-quality design and no sharp edges no risk of injuries during installation
- Partition plates for optical separation and reinforcement of insulation

## General ordering data

Type	TRP 24-230VUC 1CO EMPTY...	Version	
Order No.	<a href="#">2663030000</a>	TERMSERIES, Relay socket, Number of contacts: 1, CO contact, Rated	
GTIN (EAN)	4050118698046	control voltage: 24...230 V UC $\pm 10\%$ , Continuous current: 10 A,	
Qty.	10 ST	PUSH IN	

## RSS112024

Weidmüller Interface GmbH &amp; Co. KG

Klingenbergstraße 26

D-32758 Detmold

Germany

## Counterpart

www.weidmueller.com

## Screw connection

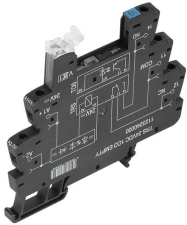

TERMSERIES empty sockets with:

- 1 CO contact
- Unique multi-voltage input from 24 to 230 V UC
- Input voltages with coloured marking: DC: blue, UC: white
- Due to high-quality design and no sharp edges no risk of injuries during installation
- Partition plates for optical separation and reinforcement of insulation

## General ordering data

Type	TRS 24VDC 1CO EMPTY	Version
Order No.	<a href="#">1123240000</a>	TERMSERIES, Relay socket, Number of contacts: 1, CO contact, Rated control voltage: 24 V DC $\pm 20\%$ , Continuous current: 10 A, Screw connection
GTIN (EAN)	4032248905485	
Qty.	10 ST	
Type	TRS 24VUC 1CO EMPTY	Version
Order No.	<a href="#">1123250000</a>	TERMSERIES, Relay socket, Number of contacts: 1, CO contact, Rated control voltage: 24 V UC $\pm 10\%$ , Continuous current: 10 A, Screw connection
GTIN (EAN)	4032248905713	
Qty.	10 ST	
Type	TRS 48VUC 1CO EMPTY	Version
Order No.	<a href="#">1123270000</a>	TERMSERIES, Relay socket, Number of contacts: 1, CO contact, Rated control voltage: 48 V UC $\pm 10\%$ , Continuous current: 10 A, Screw connection
GTIN (EAN)	4032248905423	
Qty.	10 ST	
Type	TRS 24-230VUC 1CO EMPTY	Version
Order No.	<a href="#">1123330000</a>	TERMSERIES, Relay socket, Number of contacts: 1, CO contact, Rated control voltage: 24...230 V UC $\pm 10\%$ , Continuous current: 10 A, Screw connection
GTIN (EAN)	4032248905614	
Qty.	10 ST	

## Tension clamp connection

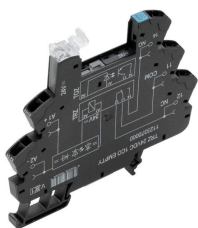

TERMSERIES empty sockets with:

- 1 CO contact
- Unique multi-voltage input from 24 to 230 V UC
- Input voltages with coloured marking: DC: blue, UC: white
- Due to high-quality design and no sharp edges no risk of injuries during installation
- Partition plates for optical separation and reinforcement of insulation

## General ordering data

Type	TRZ 24VDC 1CO EMPTY	Version
Order No.	<a href="#">1123370000</a>	TERMSERIES, Relay socket, Number of contacts: 1, CO contact, Rated control voltage: 24 V DC $\pm 20\%$ , Continuous current: 10 A, Tension-clamp connection
GTIN (EAN)	4032248905324	
Qty.	10 ST	
Type	TRZ 24VUC 1CO EMPTY	Version
Order No.	<a href="#">1123380000</a>	TERMSERIES, Relay socket, Number of contacts: 1, CO contact, Rated control voltage: 24 V UC $\pm 10\%$ , Continuous current: 10 A, Tension-clamp connection
GTIN (EAN)	4032248905195	
Qty.	10 ST	

## RSS112024

**Weidmüller Interface GmbH & Co. KG**  
 Klingenbergstraße 26  
 D-32758 Detmold  
 Germany

www.weidmueller.com

## Counterpart

Type	TRZ 48VUC 1CO EMPTY	Version
Order No.	<a href="#">1123390000</a>	TERMSERIES, Relay socket, Number of contacts: 1, CO contact, Rated
GTIN (EAN)	4032248905331	control voltage: 48 V UC $\pm 10\%$ , Continuous current: 10 A, Tension-clamp connection
Qty.	10 ST	
Type	TRZ 24-230VUC 1CO EMPTY	Version
Order No.	<a href="#">1123450000</a>	TERMSERIES, Relay socket, Number of contacts: 1, CO contact, Rated
GTIN (EAN)	4032248905508	control voltage: 24...230 V UC $\pm 10\%$ , Continuous current: 10 A, Tension-clamp connection
Qty.	10 ST	

## PUSH IN connection

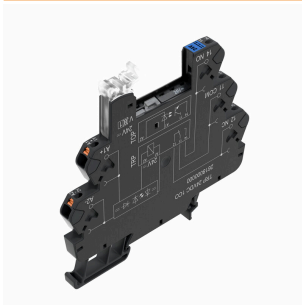

TERMSERIES empty sockets with:

- 1 CO contact
- Unique multi-voltage input from 24 to 230 V UC
- Input voltages with coloured marking: DC: blue, UC: white
- Due to high-quality design and no sharp edges no risk of injuries during installation
- Partition plates for optical separation and reinforcement of insulation

## General ordering data

Type	TRP 24VDC 1CO EMPTY	Version
Order No.	<a href="#">2618870000</a>	TERMSERIES, Relay socket, Number of contacts: 1, CO contact, Rated
GTIN (EAN)	4050118669961	control voltage: 24 V DC $\pm 20\%$ , Continuous current: 10 A, PUSH IN
Qty.	10 ST	
Type	TRP 24VUC 1CO EMPTY	Version
Order No.	<a href="#">2618910000</a>	TERMSERIES, Relay socket, Number of contacts: 1, CO contact, Rated
GTIN (EAN)	4050118669923	control voltage: 24 V UC $\pm 10\%$ , Continuous current: 10 A, PUSH IN
Qty.	10 ST	
Type	TRP 48VUC 1CO EMPTY	Version
Order No.	<a href="#">2618920000</a>	TERMSERIES, Relay socket, Number of contacts: 1, CO contact, Rated
GTIN (EAN)	4050118669916	control voltage: 48 V UC $\pm 10\%$ , Continuous current: 10 A, PUSH IN
Qty.	10 ST	
Type	TRP T 24VDC 1CO M3 EMPTY	Version
Order No.	<a href="#">2639740000</a>	TERMSERIES, Multifunction timing relay, Empty socket, Number
GTIN (EAN)	4050118797923	of contacts: 1, CO contact, Rated control voltage: 24 V DC $\pm 20\%$ ,
Qty.	10 ST	Continuous current: 10 A, PUSH IN

## RSS112024

Weidmüller Interface GmbH &amp; Co. KG

Klingenbergstraße 26

D-32758 Detmold

Germany

## Counterpart

www.weidmueller.com

## Screw connection

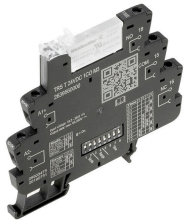

Timing relay for control signal adaptation with additional functions

Timing relays are used to coordinate fast switching processes in control systems, among other things. TERMSERIES TIMER timing relays have a on-delay, which allows for the delayed switch-on of machines, the cascaded start-up of system components or the delayed activation of consumers such as pumps or valves. They also have the One Shot and blinker functions. TERMSERIES TIMER timing relays in compact 6.4 mm terminal block format are available with either a screw connection or a PUSH IN wire connection. The timing functions and time ranges can be conveniently adjusted via the DIP switches on the side. The power supply and the respective switching status can be checked at a glance by means of the clearly visible duo LED on the ejection lever. International approvals in accordance with EN 61812 mean that they can be used anywhere in the world. TERMSERIES TIMER is compatible with the wide range of TERMSERIES accessories, thereby ensuring high levels of flexibility and simple integration into existing systems.

- Integration of additional timing functions in 6 mm TERMSERIES version
- Standard-compliant timing relays according to EN 61812
- Simple setting of timing functions and time ranges
- Integrated status LED (duo-LED in the ejection lever) for power supply and switching status

## General ordering data

Type	TRS T 24VDC 1CO M3 EMPTY	Version	
Order No.	<a href="#">2639720000</a>	TERMSERIES, Multifunction timing relay, Empty socket, Number	
GTIN (EAN)	4050118715576	of contacts: 1, CO contact, Rated control voltage: 24 V DC $\pm 20\%$ ,	
Qty.	10 ST	Continuous current: 10 A, Screw connection	

## PUSH IN connection

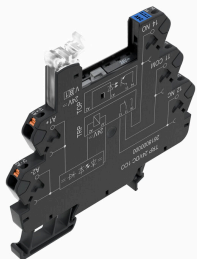

TERMSERIES empty sockets with:

- 1 CO contact
- Unique multi-voltage input from 24 to 230 V UC
- Input voltages with coloured marking: DC: blue, UC: white
- Due to high-quality design and no sharp edges no risk of injuries during installation
- Partition plates for optical separation and reinforcement of insulation

## General ordering data

Type	TRP 24-230VUC 1CO EMPTY...	Version	
Order No.	<a href="#">2663030000</a>	TERMSERIES, Relay socket, Number of contacts: 1, CO contact, Rated	
GTIN (EAN)	4050118698046	control voltage: 24...230 V UC $\pm 10\%$ , Continuous current: 10 A,	
Qty.	10 ST	PUSH IN	

**RSS112024**

**Weidmüller Interface GmbH & Co. KG**  
 Klingenbergstraße 26  
 D-32758 Detmold  
 Germany

## Counterpart

www.weidmueller.com

### Screw connection

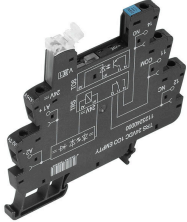

TERMSERIES empty sockets with:

- 1 CO contact
- Unique multi-voltage input from 24 to 230 V UC
- Input voltages with coloured marking: DC: blue, UC: white
- Due to high-quality design and no sharp edges no risk of injuries during installation
- Partition plates for optical separation and reinforcement of insulation

### General ordering data

Type	TRS 24-230VUC 1CO EMPTY...	Version
Order No.	<a href="#">2662870000</a>	TERMSERIES, Relay socket, Number of contacts: 1, CO contact, Rated
GTIN (EAN)	4050118698206	control voltage: 24...230 V UC ±10 %, Continuous current: 10 A,
Qty.	10 ST	Screw connection