

## CSM P 4CO

**Weidmüller Interface GmbH & Co. KG**

Klingenbergstraße 26

D-32758 Detmold

Germany

[www.weidmueller.com](http://www.weidmueller.com)



Relay sockets for the CUBESERIES CRM relays

- 4 CO output version for 2 CO and 4 CO relays
- Screw and PUSH IN connection
- PUSH IN sockets with wide pushers for screwdrivers up to 1.0 x 5.5 mm blade size
- Various cross connection possibilities
- Matching accessories such as cross-connections, retaining clips and LED modules

### General ordering data

Version	CUBESERIES, Relay socket, Number of contacts: 4, CO contact, Continuous current: 8 A, PUSH IN
Order No.	<a href="#">3053140000</a>
Type	CSM P 4CO
GTIN (EAN)	4099987022965
Qty.	10 items

## CSM P 4CO

Weidmüller Interface GmbH &amp; Co. KG

Klingenbergstraße 26

D-32758 Detmold

Germany

www.weidmueller.com

## Technical data

## Approvals

Approvals



ROHS Conform

UL File Number Search [UL Website](#)

Certificate No. (cURus) E223759

## Dimensions and weights

Depth	45.9 mm	Depth (inches)	1.8071 inch
Height	97 mm	Height (inches)	3.8189 inch
Width	31 mm	Width (inches)	1.2205 inch
Net weight	75 g		

## Temperatures

Storage temperature	Ambient temperature	-40 °C...70 °C
Operating temperature	Humidity	40 °C / 93 % rel. humidity, no condensation

## Environmental Product Compliance

RoHS Compliance Status	Compliant without exemption
REACH SVHC	No SVHC above 0.1 wt%

## Rated data UL

Certificate No. (cURus) E223759

## Control side

Status indicator No

## Load side

Rated switching voltage	250 V AC	Continuous current	12 A @ 2 CO; 8 A @ 4 CO
Max. switching voltage, AC	300 V	Contact type	4 CO contact

## General data

Operating altitude	≤ 2000 m, above sea level		
Mounting rail	TS 35		
Colour	black		
UL 94 flammability rating	V-0		
UL94 flammability rating component	Component	Socket	
	UL94 flammability rating	V-0	
	Component	Housing	
	UL94 flammability rating	V-0	

## Insulation coordination

Rated voltage	300 V	Pollution severity	2
Surge voltage category	II	Insulating material group	IIIa

## CSM P 4CO

**Weidmüller Interface GmbH & Co. KG**

Klingenbergstraße 26  
D-32758 Detmold  
Germany

[www.weidmueller.com](http://www.weidmueller.com)

## Technical data

Dielectric strength for control side - load side	4 kVeff / 1 Min.	Dielectric strength of neighbouring contacts	3 KVeff / 1 Min.
Dielectric strength to mounting rail	3 kVeff / 1 min.	Impulse withstand voltage	3 kV
Protection degree	IP20		

### Further details of approvals / standards

Certificate No. (CSA)	607178-80219312	Certificate No. (cURus)	E223759
-----------------------	-----------------	-------------------------	---------

### Connection data

Wire connection method	PUSH IN	Stripping length, rated connection	8 mm
Clamping range, rated connection	1.5 mm <sup>2</sup>	Clamping range, min.	0.5 mm <sup>2</sup>
Clamping range, max.	1.5 mm <sup>2</sup>	Wire cross-section, solid, min.	0.5 mm <sup>2</sup>
Wire cross-section, solid, min. (AWG)	AWG 20	Wire cross-section, solid, max. (AWG)	AWG 16
Wire connection cross section, finely stranded, max.	1.5 mm <sup>2</sup>	Wire cross-section, finely stranded, min. (AWG)	AWG 24
Wire cross-section, finely stranded, max. (AWG)	AWG 16	Wire connection cross-section, finely stranded with wire-end ferrules DIN 46228/4, max.	1 mm <sup>2</sup>
Blade size	0.6 x 3.5 mm		

### Classifications

ETIM 8.0	EC001456	ETIM 9.0	EC001456
ETIM 10.0	EC001456	ECLASS 14.0	27-37-16-03
ECLASS 15.0	27-37-16-03		

Wiring diagram

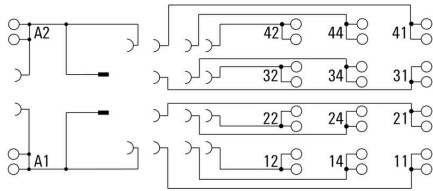

Dimensional drawing

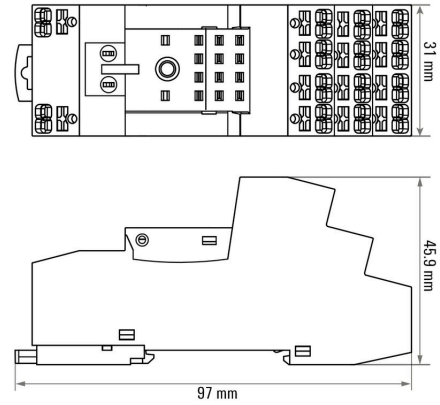



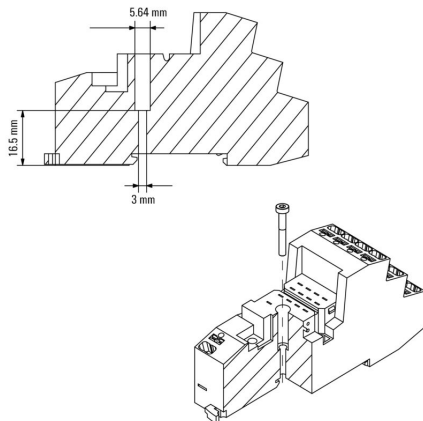

Dimensional drawing



Miscellaneous

Insertion and removal of cables

-  Stranded with ferrule →  Square crimp
-  Solid  Hex crimp
-  Stranded without ferrule (not permitted)

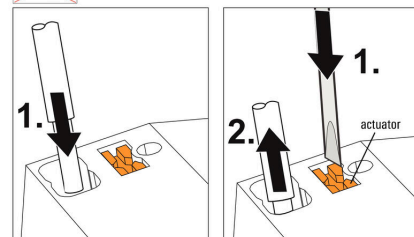

Solid cables can be inserted without opening the terminal.

Push the actuator with a screwdriver to remove the cables.

Miscellaneous

## Type code CUBESERIES socket versions

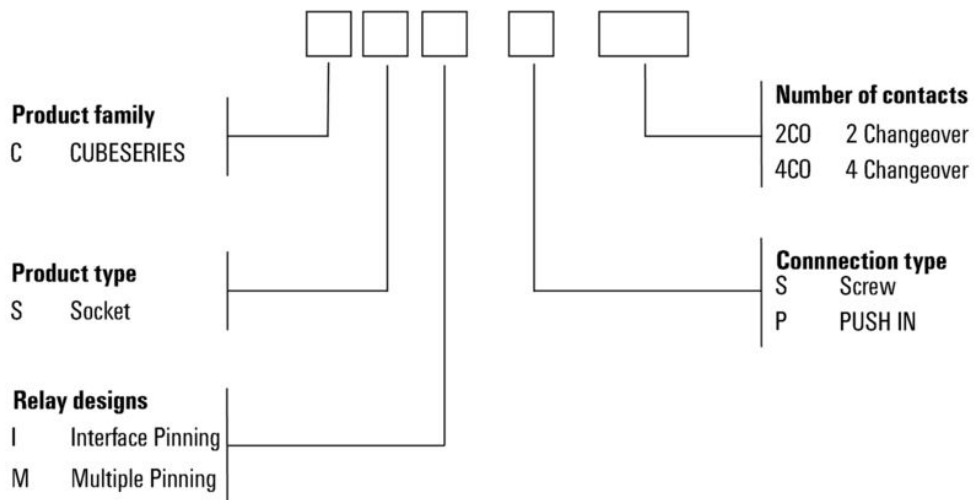

## CSM P 4CO

**Weidmüller Interface GmbH & Co. KG**  
 Klingenbergstraße 26  
 D-32758 Detmold  
 Germany

www.weidmueller.com

## Accessories

### Cross-connections



#### General ordering data

Type	CXX JMP 2P BL	Version	
Order No.	<a href="#">3053260000</a>	CUBESERIES, Cross-connector	
GTIN (EAN)	4099987023085		
Qty.	30 ST		

Type	CXX JMP 2P RD	Version	
Order No.	<a href="#">3053250000</a>	CUBESERIES, Cross-connector	
GTIN (EAN)	4099987023078		
Qty.	30 ST		

### LED



#### General ordering data

Type	CXX L 61G	Version	
Order No.	<a href="#">3053420000</a>	CUBESERIES, LED module, Rated control voltage: 6...24 V UC, Plug-in connection	
GTIN (EAN)	4099987023207		
Qty.	20 ST		

Type	CXX L 61R	Version	
Order No.	<a href="#">3053410000</a>	CUBESERIES, LED module, Rated control voltage: 6...24 V UC, Plug-in connection	
GTIN (EAN)	4099987023191		
Qty.	20 ST		

Type	CXX L 62G	Version	
Order No.	<a href="#">3053440000</a>	CUBESERIES, LED module, Rated control voltage: 24...60 V UC, Plug-in connection	
GTIN (EAN)	4099987023221		
Qty.	20 ST		

Type	CXX L 62R	Version	
Order No.	<a href="#">3053430000</a>	CUBESERIES, LED module, Rated control voltage: 24...60 V UC, Plug-in connection	
GTIN (EAN)	4099987023214		
Qty.	20 ST		

## CSM P 4CO

**Weidmüller Interface GmbH & Co. KG**  
 Klingenbergstraße 26  
 D-32758 Detmold  
 Germany

www.weidmueller.com

## Accessories

Type	CXX L 63G	Version
Order No.	<a href="#">3053460000</a>	CUBESERIES, LED module, Rated control voltage: 110...230 V UC,
GTIN (EAN)	4099987023245	Plug-in connection
Qty.	20 ST	
Type	CXX L 63R	Version
Order No.	<a href="#">3053450000</a>	CUBESERIES, LED module, Rated control voltage: 110...230 V UC,
GTIN (EAN)	4099987023238	Plug-in connection
Qty.	20 ST	

## LED and free-wheeling diode



### General ordering data

Type	CXX LD 41G	Version
Order No.	<a href="#">3053310000</a>	CUBESERIES, LED module with freewheel diode, Rated control voltage: 6...24 V DC, Plug-in connection
GTIN (EAN)	4099987023115	
Qty.	20 ST	
Type	CXX LD 41R	Version
Order No.	<a href="#">3053290000</a>	CUBESERIES, LED module with freewheel diode, Rated control voltage: 6...24 V DC, Plug-in connection
GTIN (EAN)	4099987023108	
Qty.	20 ST	
Type	CXX LD 42G	Version
Order No.	<a href="#">3053340000</a>	CUBESERIES, LED module with freewheel diode, Rated control voltage: 24...60 V DC, Plug-in connection
GTIN (EAN)	4099987023139	
Qty.	20 ST	
Type	CXX LD 42R	Version
Order No.	<a href="#">3053320000</a>	CUBESERIES, LED module with freewheel diode, Rated control voltage: 24...60 V DC, Plug-in connection
GTIN (EAN)	4099987023122	
Qty.	20 ST	

## LED and free-wheel diode



## CSM P 4C0

**Weidmüller Interface GmbH & Co. KG**  
 Klingenbergstraße 26  
 D-32758 Detmold  
 Germany

www.weidmueller.com

## Accessories

## General ordering data

Type	CXX LD 43G	Version	
Order No.	<a href="#">3053360000</a>	CUBESERIES, LED module with freewheel diode, Rated control	
GTIN (EAN)	4099987023153	voltage: 110...230 V DC, Plug-in connection	
Qty.	20 ST		

## LED and free-wheeling diode

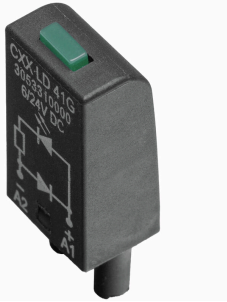

## General ordering data

Type	CXX LD 43R	Version	
Order No.	<a href="#">3053350000</a>	CUBESERIES, LED module with freewheel diode, Rated control	
GTIN (EAN)	4099987023146	voltage: 110...230 V DC, Plug-in connection	
Qty.	20 ST		

## Protection modules

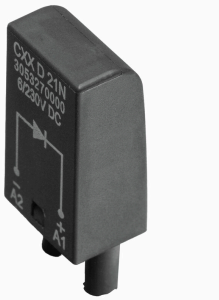

## General ordering data

Type	CXX D 21N	Version	
Order No.	<a href="#">3053270000</a>	CUBESERIES, Free-wheeling diode, Rated control voltage: 6...230 V	
GTIN (EAN)	4099987023092	DC, Plug-in connection	
Qty.	20 ST		
Type	CXX RC 51	Version	
Order No.	<a href="#">3053370000</a>	CUBESERIES, RC element, Rated control voltage: 6...24 V UC, Plug-in	
GTIN (EAN)	4099987023160	connection	
Qty.	20 ST		
Type	CXX RC 52	Version	
Order No.	<a href="#">3053390000</a>	CUBESERIES, RC element, Rated control voltage: 24...60 V UC, Plug-	
GTIN (EAN)	4099987023177	in connection	
Qty.	20 ST		
Type	CXX RC 53	Version	
Order No.	<a href="#">3053400000</a>	CUBESERIES, RC element, Rated control voltage: 110...230 V AC,	
GTIN (EAN)	4099987023184	Plug-in connection	
Qty.	20 ST		

## CSM P 4C0

**Weidmüller Interface GmbH & Co. KG**  
 Klingenbergstraße 26  
 D-32758 Detmold  
 Germany

www.weidmueller.com

## Accessories

Type	CXX V 71	Version
Order No.	<a href="#">3053470000</a>	CUBESERIES, Protective varistor, Rated control voltage: 6...24 V AC,
GTIN (EAN)	4099987023252	Plug-in connection
Qty.	20 ST	
Type	CXX V 72	Version
Order No.	<a href="#">3053480000</a>	CUBESERIES, Protective varistor, Rated control voltage: 110...130 V
GTIN (EAN)	4099987023269	AC, Plug-in connection
Qty.	20 ST	
Type	CXX V 73	Version
Order No.	<a href="#">3053490000</a>	CUBESERIES, Protective varistor, Rated control voltage: 220...240 V
GTIN (EAN)	4099987023276	AC, Plug-in connection
Qty.	20 ST	

## Cross-connections



## General ordering data

Type	CXM CCP 2P BL	Version
Order No.	<a href="#">3053230000</a>	CUBESERIES, Cross-connector
GTIN (EAN)	4099987023054	
Qty.	20 ST	
Type	CXM CCP 2P RD	Version
Order No.	<a href="#">3053220000</a>	CUBESERIES, Cross-connector
GTIN (EAN)	4099987023047	
Qty.	20 ST	
Type	CXM CCP 8P BL	Version
Order No.	<a href="#">3053210000</a>	CUBESERIES, Cross-connector
GTIN (EAN)	4099987023030	
Qty.	10 ST	
Type	CXM CCP 8P RD	Version
Order No.	<a href="#">3053200000</a>	CUBESERIES, Cross-connector
GTIN (EAN)	4099987023023	
Qty.	10 ST	

## CSM P 4CO

Weidmüller Interface GmbH &amp; Co. KG

Klingenbergstraße 26

D-32758 Detmold

Germany

www.weidmueller.com

## Accessories

## Retaining clips



Retaining clips for CUBESERIES CRI relays.

Plastic retaining clip:

- With relay ejector function
- Marking slots for MultiFit markers
- Fits on relays with and without test button

Metal retaining clip:

- For a strong hold of the relay in the socket

## General ordering data

Type	CXM CLIP M	Version	
Order No.	<a href="#">3053190000</a>	CUBESERIES, Retaining clip	
GTIN (EAN)	4099987023016		
Qty.	25 ST		
Type	CXM CLIP P	Version	
Order No.	<a href="#">3053240000</a>	CUBESERIES, Retaining clip	
GTIN (EAN)	4099987023061		
Qty.	10 ST		

## Accessories

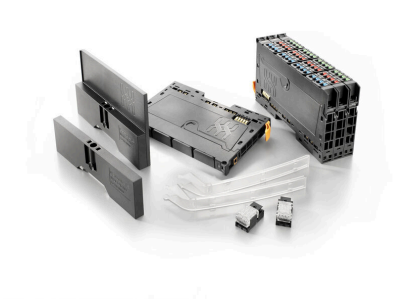

System accessory

Discover a wide range of accessories for your u-remote system - the ideal addition to make your applications even more efficient and flexible.

## General ordering data

Type	UR20-EBK-ACC	Version	
Order No.	<a href="#">1346610000</a>	End bracket, ,	
GTIN (EAN)	4050118151596		
Qty.	5 ST		

## ESG-FO 8/20



Guaranteed long service life: ESG

The multi-colour and multi-format labels have a strong adhesive layer to ensure the best possible adhesion to the underlying surface. Double laminated polyester makes the basic material very thin and yet extremely tear-resistant.

Your benefits with MultiMark

- "Different materials for various requirements"
- Can be used with equipment from many manufacturers
- Device markers with a familiar design

## CSM P 4CO

**Weidmüller Interface GmbH & Co. KG**  
Klingenbergstraße 26  
D-32758 Detmold  
Germany

[www.weidmueller.com](http://www.weidmueller.com)

## Accessories

### General ordering data

Type	ESG-FO 8/20 MM WS	Version	
Order No.	<a href="#">2620950000</a>	ESG, Device markers, 8 x 20 mm, white	
GTIN (EAN)	4050118626032		
Qty.	1000 ST		