

CRM20024

Weidmüller Interface GmbH & Co. KG

Klingenbergstraße 26

D-32758 Detmold

Germany

www.weidmueller.com



Similar to illustration

Individual relays within the CUBESERIES CRM

- Control voltages from 12 - 110 V DC and 24 - 230V AC
- 2 CO contact (12 A)
- Without test button with coloured blind plugs (AC coil: orange, DC coil: blue)
- With test button Individual relays within the CUBESERIES CRM
- Control voltages from 12 - 110 V DC and 24 - 230V AC
- 2 CO contact (12 A)
- With test buttons with colour coding (AC coil: orange, DC coil: blue)
- With mechanical status indicator

General ordering data

Version	CUBESERIES, Relay, Number of contacts: 2, CO contact AgNi, Rated control voltage: 24 V DC, Continuous current: 12 A, Plug-in connection, Test button available: No
Order No.	3052730000
Type	CRM20024
GTIN (EAN)	4099987022538
Qty.	10 items

CRM20024

Weidmüller Interface GmbH & Co. KG

Klingenbergstraße 26

D-32758 Detmold

Germany

www.weidmueller.com

Technical data

Approvals

Approvals



ROHS Conform

UL File Number Search [UL Website](#)

Certificate No. (cURus) E223474

Dimensions and weights

Depth	35.5 mm	Depth (inches)	1.3976 inch
Height	27.4 mm	Height (inches)	1.0787 inch
Width	21 mm	Width (inches)	0.8268 inch
Net weight	35 g		

Temperatures

Storage temperature	-40 °C...85 °C	Ambient temperature	-40 °C...70 °C
Operating temperature		Humidity	25 °C / 95 % rel. humidity, no condensation

Environmental Product Compliance

RoHS Compliance Status	Compliant without exemption
REACH SVHC	No SVHC above 0.1 wt%

Rated data UL

Certificate No. (cURus)	E223474
-------------------------	---------

Control side

Rated control voltage	24 V DC	Rated current DC	37.8 mA
Power rating	0.9 W	Coil resistance	640 Ω ± 10 %
Status indicator	No		

Load side

Rated switching voltage	250 V AC	Continuous current	12 A
Max. switching frequency at rated load	0.1 Hz	Max. switching voltage, AC	250 V
Max. switching voltage, DC	250 V	AC switching capacity (resistive), max.	3000 VA
DC switching capacity (resistive), max.	288 W @ 24 V	Switch-on delay	≤ 20 ms
Switch-off delay	≤ 6 ms	Contact type	2 CO contact (AgNi)
Mechanical service life	2 x 10 ⁷ switching cycles	Min. switching power	10 mA @ 12 V, 100 mA @ 5 V

General data

Operating altitude	≤ 2000 m, above sea level	Test button available	No
Mechanical switch position indicator	Yes	Colour	Transparent
UL 94 flammability rating	V-2		

Technical data

Insulation coordination

Rated voltage	250 V	Pollution severity	3
Surge voltage category	III	Dielectric strength for control side - load side	2.5 kVeff/ 1 min
Dielectric strength of neighbouring contacts	2.5 kVeff/ 1 min	Dielectric strength of open contact	1.5 kVeff /1 min.
Impulse withstand voltage	4 kV (1.2/50 µs)	Protection degree	IP40

Further details of approvals / standards

Certificate No. (CSA)	607178-80219312	Certificate No. (VDE)	40059812
Certificate No. (cURus)	E223474		

Connection data

Wire connection method	Plug-in connection	Pitch in mm (P)	5.00 mm
------------------------	--------------------	-----------------	---------

Classifications

ETIM 8.0	EC001437	ETIM 9.0	EC001437
ETIM 10.0	EC001437	ECLASS 14.0	27-37-16-01
ECLASS 15.0	27-37-16-01		

Connection diagram



Graph



Graph



Graph



Dimensional drawing

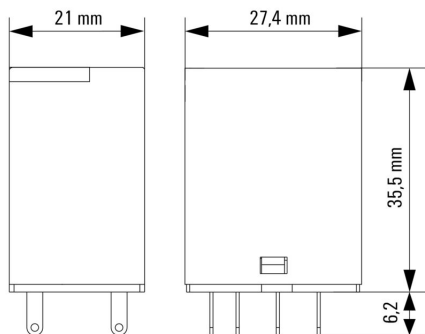

Miscellaneous

Type code CUBESERIES relay versions



Type codes