

PSSRN K 24VDC 3Z K 600VAC 20A

Weidmüller Interface GmbH & Co. KG
 Klingenbergstraße 26
 D-32758 Detmold
 Germany

www.weidmueller.com

Product image

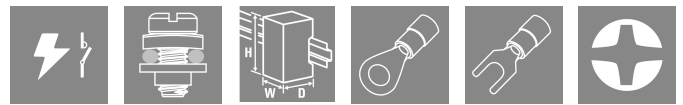

Switch high 3-phase AC loads up to 600 V AC and 20 A completely wear-free, reliable and noiseless.

- Load circuit 3-phase: 42...600 V AC / 20 A
- Compact design with a width from 54 mm
- Ready to use with integrated heat sink and mounting rail base for mounting on DIN rail TS35
- Short circuit protection with circuit breakers possible
- Output connections ring lug suitable

General ordering data

Version	Power Solid-State Relais, Solid state contactor, Rated control voltage: 5...32 V DC , Rated switching voltage: 42...600 V AC +10% -15%, Continuous current: 20 A
Order No.	2986910000
Type	PSSRN K 24VDC 3Z K 600VAC 20A
GTIN (EAN)	4099986853034
Qty.	1 items

PSSRN K 24VDC 3Z K 600VAC 20A

Weidmüller Interface GmbH & Co. KG
Klingenbergstraße 26
D-32758 Detmold
Germany

www.weidmueller.com

Technical data

Approvals

Approvals



ROHS Conform

UL File Number Search [UL Website](#)

Certificate no. (cULus) E537615

Dimensions and weights

Depth	102.5 mm	Depth (inches)	4.0354 inch
Height	110 mm	Height (inches)	4.3307 inch
Width	54 mm	Width (inches)	2.126 inch
Net weight	510 g		

Temperatures

Storage temperature	-40 °C...100 °C	Ambient temperature	-40 °C...80 °C
Operating temperature		Humidity	95% relative humidity, non-condensing @ 40°C

Probability of failure

MTTF 14 a

Environmental Product Compliance

RoHS Compliance Status Compliant with exemption

RoHS Exemption (if applicable/known) 7cl

REACH SVHC No SVHC above 0.1 wt%

Control side

Rated control voltage	5...32 V DC	Nominal control current	23 mA...31 mA
Status indicator	Green LED		

Load side

Rated switching voltage	42...600 V AC +10% -15%	Continuous current	20 A (AC 51) @ 40 °C; 10 A (AC 53)
Max. switching current	25 A	Load category	AC 51, AC 53
Inrush current	61 A	Pulse load, max. current	600 A (10 ms, non-recurrent)
Load limit integral (I^2t) <10 ms	1800 A ² s	Switch-on delay	≤ 10 ms
Switch-off delay	≤ 10 ms	Leakage current	5 mA
Min. switching current	250 mA	Short-circuit-proof	No
Protective circuit, load side	Integrated varistor	Contact type	3 NO contacts (Thyristor (zero-cross switch))
Output voltage frequency range	45...65 Hz		

General data

Version	3-phase with heat sink mounted	Mounting rail	TS 35
Colour	black		

PSSRN K 24VDC 3Z K 600VAC 20A

Weidmüller Interface GmbH & Co. KG
 Klingenbergstraße 26
 D-32758 Detmold
 Germany

www.weidmueller.com

Technical data

Insulation coordination

Pollution severity	2	Surge voltage category	III
Dielectric strength for control side - load side	4 kVeff	Dialectric strength of load side - housing	4 kVeff
Impulse withstand voltage	6 kV (1.2/50 µs)	Protection degree	IP20

Further details of approvals / standards

Certificate no. (cULus)	E537615
-------------------------	---------

Connection data (control side)

Wire connection cross-section, twin wire-end ferrules, control side, min.	0.5 mm ²	Wire connection cross-section, solid, control side, max.	2.5 mm ²
Wire connection cross-section, solid, control side, max. (AWG)	AWG 18	Wire connection cross-section, twin wire-end ferrules, control side, max.	2.5 mm ²
Wire connection cross-section, solid, control side, min. (AWG)	AWG 12	Stripping length, control side	8 mm
Wire connection method (control side)	Screw connection	Min. rated connection clamping range (control side)	0.75 mm ²
Max. rated connection clamping range (control side)	2.5 mm ²	Wire connection (control side)	M3 screw with captivated washer
Min. tightening torque (control side)	0.5 Nm	Max. tightening torque (control side)	0.6 Nm
Blade size (control side)	PZ 1		

Connection data (load side)

Stripping length, load side	12 mm	Wire connection cross-section, finely stranded, two clampable wires, load side, min.	1 mm ²
Wire connection cross-section, stranded, load side, min. (AWG)	AWG 10	Wire connection cross-section, finely stranded, two clampable wires, load side, min. (AWG)	AWG 10
Wire connection cross-section, solid, load side, min. (AWG)	AWG 10	Wire connection cross-section, stranded, load side, max. (AWG)	AWG 18
Wire connection cross-section, solid, load side, min.	2.5 mm ²	Wire connection cross-section, twin wire-end ferrules, load side, max. (AWG)	AWG 18
Wire connection cross-section, twin wire-end ferrules, load side, min. (AWG)	AWG 12	Wire connection cross-section, solid, load side, max. (AWG)	AWG 14
Wire connection cross-section, finely stranded, two clampable wires, load side, max.	6 mm ²	Wire connection cross-section, stranded, load side, min.	1 mm ²
Wire connection cross-section, solid, load side, max.	6 mm ²	Wire connection cross-section, finely stranded, two clampable wires, load side, max. (AWG)	AWG 18
Wire connection cross-section, stranded, load side, max.	6 mm ²	Wire connection method (load side)	Screw connection
Min. rated connection clamping range (load side)	2.5 mm ²	Max. rated connection clamping range (load side)	6 mm ²
Wire connection (load side)	M4 screw with captivated washer	Min. tightening torque (load side)	1.5 Nm
Max. tightening torque (load side)	2 Nm	Blade size (load side)	PZ 2

Classifications

ETIM 8.0	EC002055	ETIM 9.0	EC002055
ETIM 10.0	EC002055	ECLASS 14.0	27-37-10-14
ECLASS 15.0	27-37-10-14		

PSSRN K 24VDC 3Z K 600VAC 20A

Weidmüller Interface GmbH & Co. KG
 Klingenbergstraße 26
 D-32758 Detmold
 Germany

www.weidmueller.com

Drawings

Wiring diagram

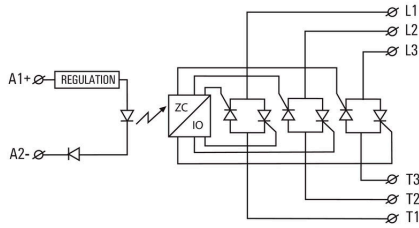

Graph

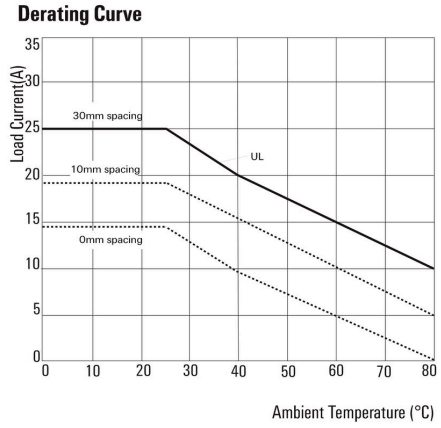

Derating curve

Graph

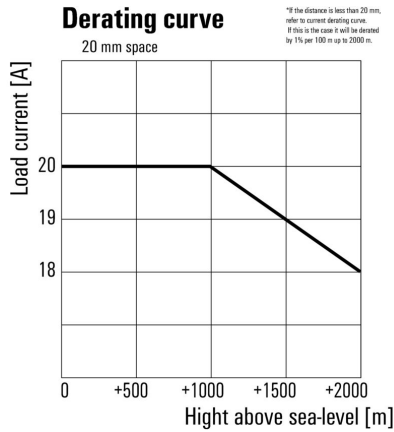

Derating curve

Graph

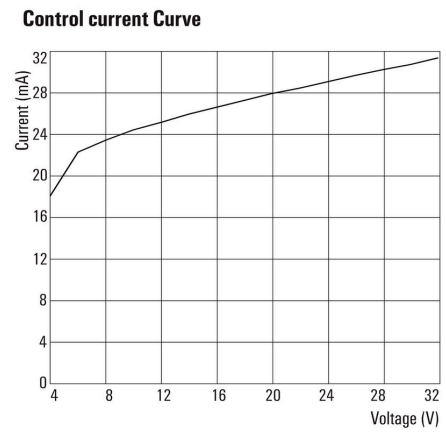

Graph

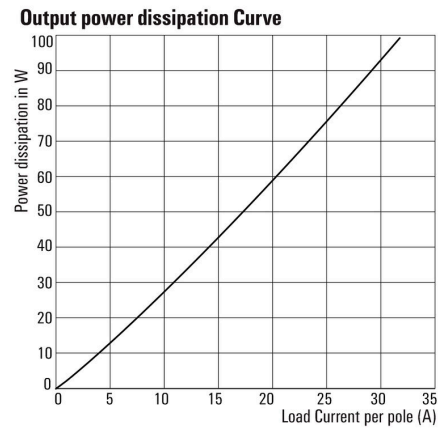

Dimensional drawing

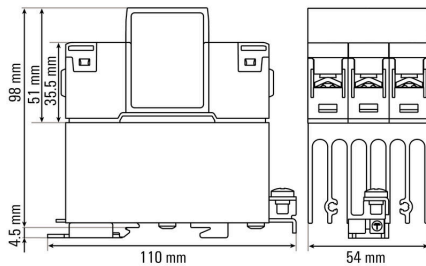

Miscellaneous

Power Solid-State Relay (PSSR)

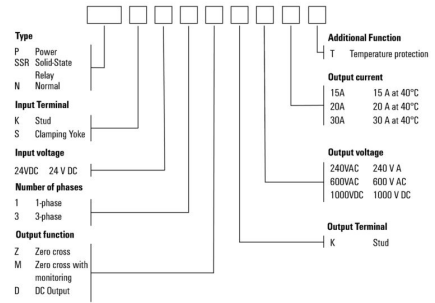

Type codes

Miscellaneous

Suggested mounting
 distances to ensure
 optimal heat dissipation

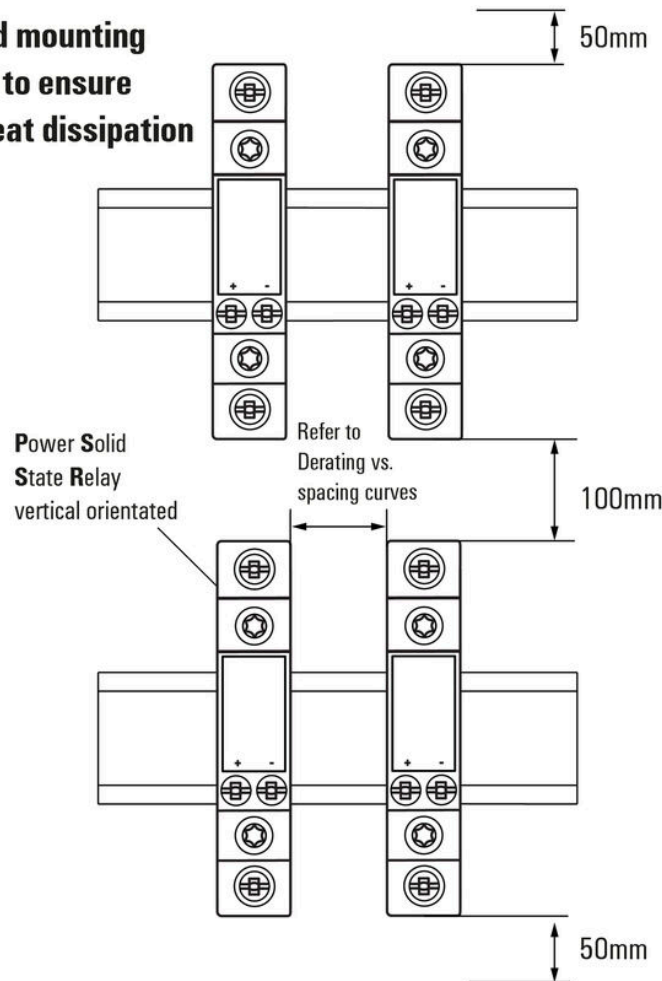

Miscellaneous

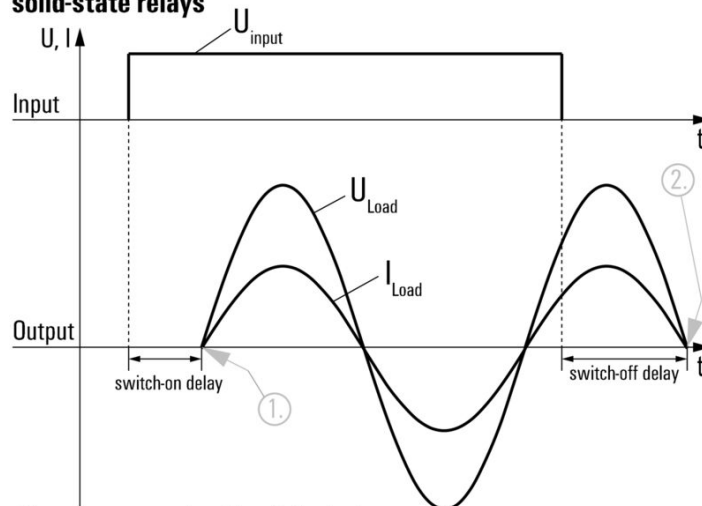
Signal characteristics of zero cross switching
solid-state relays

Shown at an example with resistive load.

1. Switches on at first zero cross of mains voltage while control input gets signal.
2. Switches off at next zero cross of mains current after control input signal was switched off.

Switching DC voltages is not possible with this solid-state relays.