

SAI-08D-VPHP-5A-M120-OL2-EX

Weidmüller Interface GmbH & Co. KG
Klingenbergstraße 26
D-32758 Detmold
Germany

www.weidmueller.com



Passive M12 distributors are available in all conceivable forms and configurations. Furthermore, a number of special versions, e.g. SAI distributors for EX zones or the ergonomic M8, are available only from Weidmüller. These innovative products are backed up by numerous proprietary rights.

General ordering data

Version	Hood version Ex, M12, 30 V, A-coded, LED: No, LED initiator: No, Wiring type: PNP
Order No.	2921130000
Type	SAI-08D-VPHP-5A-M120-OL2-EX
GTIN (EAN)	4099986612808
Qty.	1 items

SAI-08D-VPHP-5A-M120-OL2-EX

Weidmüller Interface GmbH & Co. KG
 Klingenbergstraße 26
 D-32758 Detmold
 Germany

www.weidmueller.com

Technical data

Approvals

Approvals



Dimensions and weights

Depth	60 mm	Depth (inches)	2.3622 inch
Height	61.3 mm	Height (inches)	2.4134 inch
Length	152 mm	Length (inches)	5.9842 inch
Net weight	250 g		

Temperatures

Operating temperature -40 - 60°C

Environmental Product Compliance

RoHS Compliance Status	Compliant with exemption
RoHS Exemption (if applicable/known)	6c
REACH SVHC	Lead 7439-92-1
SCIP	080d521b-fe82-472b-91b0-e57e0e68f901

Connection data

Wire connection method	PUSH IN	Cable gland	M 20
Clamping range, min.	0.14 mm ²	Clamping range, max.	1.5 mm ²
Wire connection cross section AWG, min.	AWG 26	Wire connection cross section AWG, max.	AWG 16
Solid, min. H05(07) V-U	0.14 mm ²	Solid, max. H05(07) V-U	1.5 mm ²
Flexible, min. H05(07) V-K	0.14 mm ²	Flexible, max. H05(07) V-K	1.5 mm ²
w. plastic collar ferrule, DIN 46228 pt 4, min.	0.28 mm ²	w. plastic collar ferrule, DIN 46228 pt 4, max.	1 mm ²
w. wire end ferrule, DIN 46228 pt 1, min.	0.25 mm ²	w. wire end ferrule, DIN 46228 pt 1, max.	1 mm ²
Distributor outlet	Hood version Ex		

Electrical data

Rated voltage, min.	0 V	Rated voltage, max.	30 V
Max. current-carrying capacity per slot	0.8 A	Total current	0.8 A
Current per signal	0.8 A		

General technical data

Protection degree	IP66, IP67	Surge voltage category	III
Plug-in station coding	A-coded	Number of poles	5
Number of contact sockets	8	Connection thread	M12
Pollution severity	3	Fire behaviour	V-0
Plugging cycles	≤ 50	LED	No
LED initiator	No		

SAI-08D-VPHP-5A-M120-OL2-EX

Weidmüller Interface GmbH & Co. KG
 Klingenbergstraße 26
 D-32758 Detmold
 Germany

www.weidmueller.com

Technical data

Material data

Material O-Ring	FKM	Housing main material	Pocan (base module), Zinc diecast (hood)
Housing colour	black (similar to RAL 9005)	Hood sealing material	Polyurethane foamed
Screw socket	Nickel-plated CuZn	Contact material	CuZn
Contact surface	Gold-plated	Contact carrier material	PBT (UL 94 V0)
Cable gland material	metal		

Important note

Product information	Included in delivery: <ul style="list-style-type: none"> • 2 x Protection cap M12 • 1 x Cable gland M20x1.5 • 1 x Sealing Plug M20x1.5 • 1 x MultiCard ESG 9/17 K Device marker
---------------------	---

Classifications

ETIM 8.0	EC003558	ETIM 9.0	EC003558
ETIM 10.0	EC003558	ECLASS 14.0	27-44-01-11
ECLASS 15.0	27-44-01-11		

SAI-08D-VPHP-5A-M120-OL2-EX

Weidmüller Interface GmbH & Co. KG
 Klingenbergstraße 26
 D-32758 Detmold
 Germany

www.weidmueller.com

Drawings

Similar to illustration



Similar to illustration



Miscellaneous



Dimensioned drawing

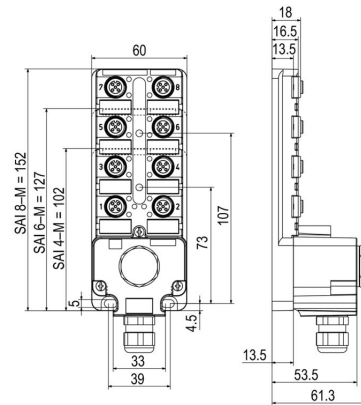

Wiring diagram

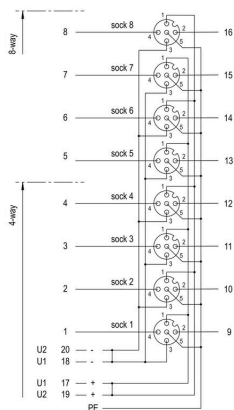

SAI-08D-VPHP-5A-M12O-OL2-EX

Weidmüller Interface GmbH & Co. KG
 Klingenbergstraße 26
 D-32758 Detmold
 Germany

www.weidmueller.com

Accessories

Accessories

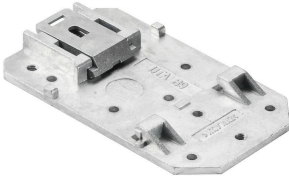

Passive M12 distributors are available in all conceivable forms and configurations. Furthermore, a number of special versions, e.g. SAI distributors for EX zones or the ergonomic M8, are available only from Weidmüller. These innovative products are backed up by numerous proprietary rights.

General ordering data

Type	SAI-TS35 MF	Version	
Order No.	1917400000		
GTIN (EAN)	4032248551330		
Qty.	1 ST		

M12



Protective caps protect unassigned plug-in stations against external influences.

General ordering data

Type	SAI-SK-M12-UNI 2029	Version	
Order No.	2330260000		Protected component assemblies, Protective cap
GTIN (EAN)	4032248592067		
Qty.	20 ST		

Blank



ESG is the tried-and-tested marker in MultiCard format for use on many well-known electrical devices. The result is high-quality device marking with a high-contrast appearance.

Various types are available for devices from manufacturers like Siemens, ABB, Beckhoff etc.

Advantages at a glance:

- Tags for universal usage, self-adhesive or clip-on tags, depending on type
- For aligned equipment, e.g. circuit breakers, we supply ESG markers for clipping onto tag rails
- Individual laser-quality printing according to specifications

For custom printing: Please send us a file of our labeling software M-Print PRO or M-Print PRO Online (without installation) for your labeling specifications.

SAI-08D-VPHP-5A-M120-OL2-EX

Weidmüller Interface GmbH & Co. KG
 Klingenbergstraße 26
 D-32758 Detmold
 Germany

www.weidmueller.com

Accessories

General ordering data

Type	ESG 9/20 MC NE WS	Version	
Order No.	1609940000	ESG, Device markers x 20 mm, PA 66, Colour: white, pluggable	
GTIN (EAN)	4008190203528		
Qty.	200 ST		

Screwty® cable gland tool with torque function



The ideal tool for any application
 Screwty® is the ideal, all-purpose tool for tightening all common sensor and actuator cables. Even difficult-to-reach round plugs are accessible using the Screwty®. A simple turning movement tightens and loosens the connectors without the need for excessive force. The Screwty® is a unique and global solution since it fits with most cables and plugs from other vendors (over 90 %). The Screwty® consists of a handle with a conventional 1/4" adapter. Thus it can be used for all sizes: for M12 and M8 round plug-in connectors, and for M12F and M8F customisable plugs and sockets, as well as for all M23 plugs and sockets.

General ordering data

Type	SCREWTY SET -DM	Version	
Order No.	1920000000	Cable gland tool for M8, M12 lines and connectors	
GTIN (EAN)	4032248436859		
Qty.	1 ST		

5-pole, A-coded

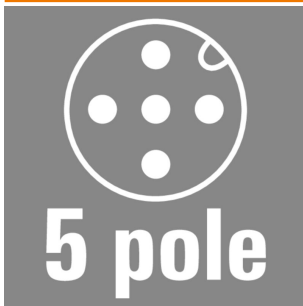

Sensor cables for use in Ex applications with intrinsically safe circuits. Please refer to the manufacturer's declaration in the product downloads for further information

General ordering data

Type	SAIL-M12G-5-5.OUBL	Version	
Order No.	3107980500	Sensor/actuator line, One end without connector, M12, Number of poles : 5, 5 m, pin, straight, Shielded: No, LED: No, Sheath material: PUR, Halogen: No	
GTIN (EAN)	4099987808064		
Qty.	1 ST		
Type	SAIL-M12BG-5-5.OUBL	Version	
Order No.	3107970500	Sensor/actuator line, One end without connector, M12, Number of poles : 5, 5 m, Female socket, straight, Shielded: No, LED: No, Sheath material: PUR, Halogen: No	
GTIN (EAN)	4099987803854		
Qty.	1 ST		
Type	SAIL-M12W-5-5.OUBL	Version	
Order No.	3107990500	Sensor/actuator line, One end without connector, M12, Number of poles : 5, 5 m, pin, 90°, Shielded: No, LED: No, Sheath material: PUR, Halogen: No	
GTIN (EAN)	4099987808101		
Qty.	1 ST		

SAI-08D-VPHP-5A-M120-OL2-EX

Weidmüller Interface GmbH & Co. KG
 Klingenbergstraße 26
 D-32758 Detmold
 Germany

www.weidmueller.com

Accessories

Type	SAIL-M12GM12G-5-5.0UBL	Version
Order No.	2955210500	Sensor/actuator line, Connecting line, M12, Number of poles : 5, 5 m,
GTIN (EAN)	4099987808293	pin, straight - socket, straight, Shielded: No, LED: No, Sheath material:
Qty.	1 ST	PUR, Halogen: No

2-pole, A-coded

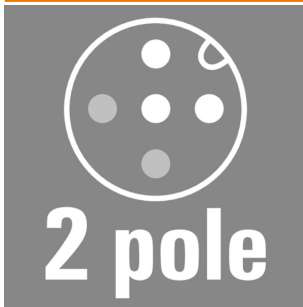

Sensor cables for use in Ex applications with intrinsically safe circuits. Please refer to the manufacturer's declaration in the product downloads for further Information

General ordering data

Type	SAIL-M12G-2SD5.0UBL	Version
Order No.	3108010500	Sensor/actuator line, One end without connector, M12, Number of
GTIN (EAN)	4099987813273	poles : 2, 5 m, pin, straight, Shielded: Yes, LED: No, Sheath material:
Qty.	1 ST	PUR, Halogen: No

4-pole, A-coded

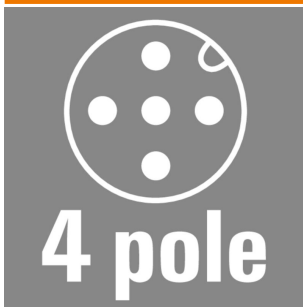

Sensor cables for use in Ex applications with intrinsically safe circuits. Please refer to the manufacturer's declaration in the product downloads for further Information

General ordering data

Type	SAIL-M12G-4SD5.0UBL	Version
Order No.	3108030500	Sensor/actuator line, One end without connector, M12, Number of
GTIN (EAN)	4099987834346	poles : 4, 5 m, pin, straight, Shielded: Yes, LED: No, Sheath material:
Qty.	1 ST	PUR, Halogen: No

SAI-08D-VPHP-5A-M120-OL2-EX

Weidmüller Interface GmbH & Co. KG
 Klingenbergstraße 26
 D-32758 Detmold
 Germany

www.weidmueller.com

Accessories

2-pole, A-coded

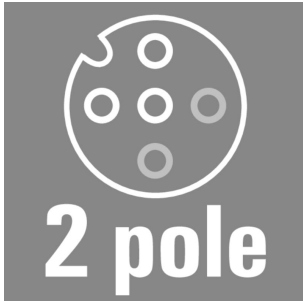

Sensor cables for use in Ex applications with intrinsically safe circuits. Please refer to the manufacturer's declaration in the product downloads for further Information

General ordering data

Type	SAIL-M12BG-2SD5.OUBL	Version	
Order No.	3108000500	Sensor/actuator line, One end without connector, M12, Number of poles : 2, 5 m, Female socket, straight, Shielded: Yes, LED: No, Sheath material: PUR, Halogen: No	
GTIN (EAN)	4099987808507		
Qty.	1 ST		

4-pole, A-coded

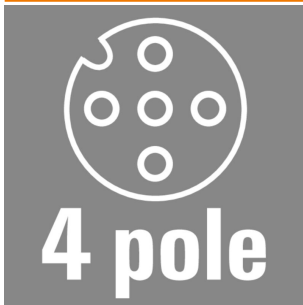

Sensor cables for use in Ex applications with intrinsically safe circuits. Please refer to the manufacturer's declaration in the product downloads for further Information

General ordering data

Type	SAIL-M12BG-4SD5.OUBL	Version	
Order No.	3106100500	Sensor/actuator line, One end without connector, M12, Number of poles : 4, 5 m, Female socket, straight, Shielded: Yes, LED: No, Sheath material: PUR, Halogen: No	
GTIN (EAN)	4099987175678		
Qty.	1 ST		

2-pole, A-coded

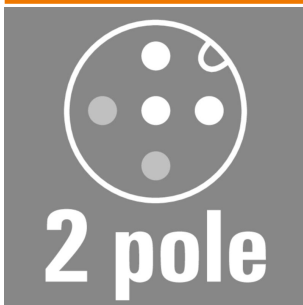

Sensor cables for use in Ex applications with intrinsically safe circuits. Please refer to the manufacturer's declaration in the product downloads for further Information

General ordering data

Type	SAIL-M12W-2SD5.OUBL	Version	
Order No.	3108020500	Sensor/actuator line, One end without connector, M12, Number of poles : 2, 5 m, pin, 90°, Shielded: Yes, LED: No, Sheath material: PUR, Halogen: No	
GTIN (EAN)	4099987814584		
Qty.	1 ST		

SAI-08D-VPHP-5A-M120-OL2-EX

Weidmüller Interface GmbH & Co. KG
 Klingenbergstraße 26
 D-32758 Detmold
 Germany

www.weidmueller.com

Accessories

4-pole, A-coded

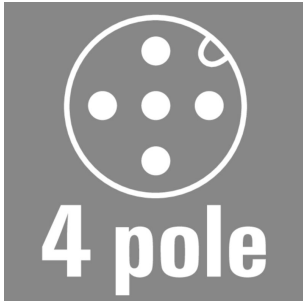

Sensor cables for use in Ex applications with intrinsically safe circuits. Please refer to the manufacturer's declaration in the product downloads for further Information

General ordering data

Type	SAIL-M12W-4SD5.0UBL	Version	
Order No.	3108040500	Sensor/actuator line, One end without connector, M12, Number of poles : 4, 5 m, pin, 90°, Shielded: Yes, LED: No, Sheath material: PUR,	
GTIN (EAN)	4099987835138	Halogen: No	
Qty.	1 ST		

2-pole, A-coded

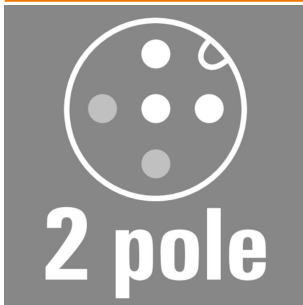

Sensor cables for use in Ex applications with intrinsically safe circuits. Please refer to the manufacturer's declaration in the product downloads for further Information

General ordering data

Type	SAIL-M12GM12G-2SD5.0UBL	Version	
Order No.	2993610500	Sensor/actuator line, Connecting line, M12, Number of poles : 2, 5 m, pin, straight - socket, straight, Shielded: Yes, LED: No, Sheath material: PUR, Halogen: No	
GTIN (EAN)	4099987814881		
Qty.	1 ST		

4-pole, A-coded

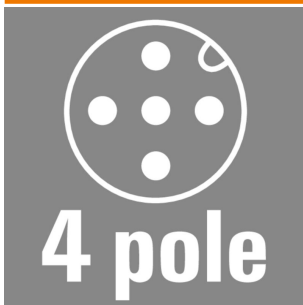

Sensor cables for use in Ex applications with intrinsically safe circuits. Please refer to the manufacturer's declaration in the product downloads for further Information

General ordering data

Type	SAIL-M12GM12G-4SD5.0UBL	Version	
Order No.	2955220500	Sensor/actuator line, Connecting line, M12, Number of poles : 4, 5 m, pin, straight - socket, straight, Shielded: Yes, LED: No, Sheath material: PUR, Halogen: No	
GTIN (EAN)	4099987836265		
Qty.	1 ST		