

SVZ 7.62HP/02/180F SN BK BX SO

Weidmüller Interface GmbH & Co. KG
 Klingenbergstraße 26
 D-32758 Detmold
 Germany

www.weidmueller.com

Product image

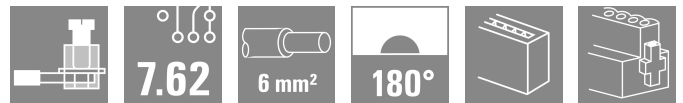

High-performance male header with the proven, 100% maintenance-free Weidmüller steel clamping yoke. Side-by-side mounting without sacrificing any poles or with patented multifunction flange for secure, fast fixing without tools. Maximum connection and operating reliability thanks to a mating profile that prevents incorrect connection, unique coding diversity, incorrect wiring protection. Suitable for labelling.

General ordering data

Version	PCB plug-in connector, male plug, 7.62 mm, Number of poles: 2, 180°, Clamping yoke connection, Box
Order No.	2917390000
Type	SVZ 7.62HP/02/180F SN BK BX SO
GTIN (EAN)	4099986549180
Qty.	50 items
Product data	IEC: 1000 V / 57 A / 0.2 - 10 mm ² UL: 600 V / 42 A / AWG 24 - AWG 8
Packaging	Box

SVZ 7.62HP/02/180F SN BK BX SO

Weidmüller Interface GmbH & Co. KG
Klingenbergstraße 26
D-32758 Detmold
Germany

www.weidmueller.com

Technical data

Approvals

Approvals



UL File Number Search [UL Website](#)
Certificate No. (cURus) E60693

Dimensions and weights

Depth	41.45 mm	Depth (inches)	1.6319 inch
Height	23.1 mm	Height (inches)	0.9094 inch
Width	30.48 mm	Width (inches)	1.2 inch
Net weight	9.03 g		

Environmental Product Compliance

RoHS Compliance Status Compliant without exemption
REACH SVHC No SVHC above 0.1 wt%

System Parameters

Product family	OMNIMATE Power - series BV/SV 7.62HP	Wire connection method	Clamping yoke connection
Pitch in mm (P)	7.62 mm	Pitch in inches (P)	0.300 "
Conductor outlet direction	180°	Number of poles	2
Pin series quantity	1	Protection degree	IP20
Screwdriver blade	0.6 x 3.5	Plugging cycles	25

Material data

Insulating material	PA GF	Colour	black
Colour chart (similar)	RAL 9011	Insulating material group	II
Comparative Tracking Index (CTI)	≥ 500	Moisture Level (MSL)	
UL 94 flammability rating	V-0	Contact material	Cu-alloy
Contact surface	tinned	Layer structure of plug contact	4...6 µm Sn glossy
Storage temperature, min.	-40 °C	Storage temperature, max.	70 °C
Operating temperature, min.	-50 °C	Operating temperature, max.	125 °C

Conductors suitable for connection

Solid, min. H05(07) V-U	0.2 mm ²		
Solid, max. H05(07) V-U	6 mm ²		
Flexible, min. H05(07) V-K	0.5 mm ²		
Flexible, max. H05(07) V-K	10 mm ²		
w. wire end ferrule, DIN 46228 pt 1, min.	0.25 mm ²		
w. wire end ferrule, DIN 46228 pt 1, max.	6 mm ²		
Clampable conductor	Cross-section for conductor connection	Type	fine-wired
		nominal	0.5 mm ²
	wire end ferrule	Stripping length	nominal 14 mm
		Recommended wire-end ferrule	H0.5/18 OR
	Cross-section for conductor connection	Type	fine-wired
		nominal	1 mm ²
wire end ferrule	Stripping length	nominal 15 mm	

SVZ 7.62HP/02/180F SN BK BX SO

Weidmüller Interface GmbH & Co. KG
 Klingenbergstraße 26
 D-32758 Detmold
 Germany

www.weidmueller.com

Technical data

	Recommended wire-end ferrule	H1.0/18 GE
Cross-section for conductor connection	Type	fine-wired
	nominal	1.5 mm ²
wire end ferrule	Stripping length	nominal 15 mm
	Recommended wire-end ferrule	H1.5/18D SW
	Stripping length	nominal 12 mm
	Recommended wire-end ferrule	H1.5/12
Cross-section for conductor connection	Type	fine-wired
	nominal	0.75 mm ²
wire end ferrule	Stripping length	nominal 14 mm
	Recommended wire-end ferrule	H0.75/18 W
Cross-section for conductor connection	Type	fine-wired
	nominal	2.5 mm ²
wire end ferrule	Stripping length	nominal 14 mm
	Recommended wire-end ferrule	H2.5/19D BL
	Stripping length	nominal 12 mm
	Recommended wire-end ferrule	H2.5/12
Cross-section for conductor connection	Type	fine-wired
	nominal	4 mm ²
wire end ferrule	Stripping length	nominal 12 mm
	Recommended wire-end ferrule	H4.0/12
	Stripping length	nominal 14 mm
	Recommended wire-end ferrule	H4.0/20D GR
Cross-section for conductor connection	Type	fine-wired
	nominal	6 mm ²
wire end ferrule	Stripping length	nominal 14 mm
	Recommended wire-end ferrule	H6.0/20 SW
	Stripping length	nominal 12 mm
	Recommended wire-end ferrule	H6.0/12

Reference text The outside diameter of the plastic collar should not be larger than the pitch (P). Length of ferrules is to be chosen depending on the product and the rated voltage.

Rated data acc. to IEC

tested acc. to standard	IEC 60664-1, IEC 61984	Rated current, min. number of poles (Tu=20°C)	57 A
Rated current, max. number of poles (Tu=20°C)	41 A	Rated current, min. number of poles (Tu=40°C)	41 A
Rated voltage for surge voltage class / pollution degree II/2	1000 V	Rated voltage for surge voltage class / pollution degree III/2	1000 V
Rated impulse voltage for surge voltage class/ pollution degree II/2	6 kV	Rated impulse voltage for surge voltage class/ pollution degree III/2	8 kV
Creepage distance, min.	13.8 mm	Clearance, min.	13.56 mm

Rated data acc. to UL 1059

Institute (cURus)	CURUS	Certificate No. (cURus)	E60693
Rated voltage (Use group B / UL 1059)	600 V	Rated voltage (Use group C / UL 1059)	600 V
Rated voltage (Use group D / UL 1059)	600 V	Rated current (Use group B / UL 1059)	42 A
Rated current (Use group C / UL 1059)	42 A	Rated current (Use group D / UL 1059)	5 A

SVZ 7.62HP/02/180F SN BK BX SO

Weidmüller Interface GmbH & Co. KG
 Klingenbergstraße 26
 D-32758 Detmold
 Germany

www.weidmueller.com

Technical data

Wire cross-section, AWG, min.	AWG 24	Wire cross-section, AWG, max.	AWG 8
Reference to approval values	Specifications are maximum values, details - see approval certificate.		

Packing

Packaging	Box	VPE length	354.00 mm
VPE width	136.00 mm	VPE height	48.00 mm

Important note

IPC conformity	Conformity: The products are developed, manufactured and delivered according international recognized standards and norms and comply with the assured properties in the data sheet resp. fulfill decorative properties in accordance with IPC-A-610 "Class 2". Further claims on the products can be evaluated on request.
Notes	<ul style="list-style-type: none"> In accordance with IEC 61984, OMNIMATE-connectors are connectors without breaking capacity (COC). During designated use, connectors are not allowed to be engaged or disengaged when live or under load Long term storage of the product with average temperature of 50 °C and maximum humidity 70%, 36 months

Classifications

ETIM 8.0	EC002638	ETIM 9.0	EC002638
ETIM 10.0	EC002638	ECLASS 14.0	27-46-02-02
ECLASS 15.0	27-46-02-02		

SVZ 7.62HP/02/180F SN BK BX SO

Weidmüller Interface GmbH & Co. KG
 Klingenbergstraße 26
 D-32758 Detmold
 Germany

www.weidmueller.com

Drawings

Product image



Dimensional drawing

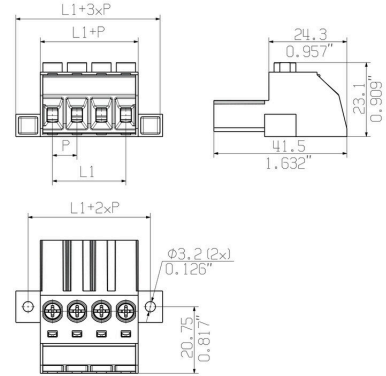

Graph

