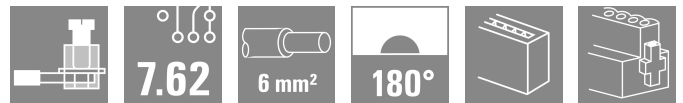

BVZ 7.62HP/02/180FC SN BK BX SO

Weidmüller Interface GmbH & Co. KG
 Klingenbergstraße 26
 D-32758 Detmold
 Germany

www.weidmueller.com

Product image

High-performance female header with the proven, 100% maintenance-free Weidmüller steel clamping yoke. Side-by-side mounting without sacrificing any poles or with patented multifunction flange for secure, fast fixing without tools. Maximum operating reliability thanks to a mating profile that prevents incorrect connection, unique coding diversity, protection against faulty wiring, 4-point contact. Suitable for labelling.

General ordering data

Version	PCB plug-in connector, female plug, 7.62 mm, Number of poles: 2, 180°, Clamping yoke connection, Clamping range, max. : 10 mm ² , Box
Order No.	2917360000
Type	BVZ 7.62HP/02/180FC SN BK BX SO
GTIN (EAN)	4099986549159
Qty.	50 items
Product data	IEC: 1000 V / 57 A / 0.2 - 10 mm ² UL: 600 V / 40.5 A
Packaging	Box

BVZ 7.62HP/02/180FC SN BK BX SO

Weidmüller Interface GmbH & Co. KG
Klingenbergstraße 26
D-32758 Detmold
Germany

www.weidmueller.com

Technical data

Approvals

Approvals



UL File Number Search [UL Website](#)
Certificate No. (cURus) E60693

Dimensions and weights

Depth	42.1 mm	Depth (inches)	1.6575 inch
Height	23.1 mm	Height (inches)	0.9094 inch
Width	30.48 mm	Width (inches)	1.2 inch
Net weight	11.27 g		

Environmental Product Compliance

RoHS Compliance Status Compliant without exemption
REACH SVHC No SVHC above 0.1 wt%

System Parameters

Product family	OMNIMATE Power - series BV/SV 7.62HP	Wire connection method	Clamping yoke connection
Pitch in mm (P)	7.62 mm	Pitch in inches (P)	0.300 "
Conductor outlet direction	180°	Number of poles	2
Pin series quantity	1	Protection degree	IP20
Tightening torque, min.	0.5 Nm	Tightening torque, max.	0.6 Nm
Clamping screw	M 3	Screwdriver blade	0.6 x 3.5
Plugging cycles	25	Plugging force/pole, max.	16.5 N
Pulling force/pole, max.	11 N		

Material data

Insulating material	PA GF	Colour	black
Colour chart (similar)	RAL 9011	Insulating material group	II
Comparative Tracking Index (CTI)	≥ 500	Moisture Level (MSL)	
UL 94 flammability rating	V-0	Contact material	Copper alloy
Contact surface	tinned	Layer structure of plug contact	6...8 µm Sn glossy
Storage temperature, min.	-40 °C	Storage temperature, max.	70 °C
Operating temperature, min.	-50 °C	Operating temperature, max.	125 °C

Conductors suitable for connection

Clamping range, min.	0.2 mm ²
Clamping range, max.	10 mm ²
Wire connection cross section AWG, min.	AWG 24
Wire connection cross section AWG, max.	AWG 8
Solid, min. H05(07) V-U	0.2 mm ²
Solid, max. H05(07) V-U	6 mm ²
Flexible, min. H05(07) V-K	0.2 mm ²
Flexible, max. H05(07) V-K	10 mm ²
w. plastic collar ferrule, DIN 46228 pt 4, 0.2 mm ² min.	
w. plastic collar ferrule, DIN 46228 pt 4, 6 mm ² max.	

BVZ 7.62HP/02/180FC SN BK BX SO

Weidmüller Interface GmbH & Co. KG
 Klingenbergstraße 26
 D-32758 Detmold
 Germany

www.weidmueller.com

Technical data

w. wire end ferrule, DIN 46228 pt 1, 0.5 mm²
 min.

w. wire end ferrule, DIN 46228 pt 1, 6 mm²
 max.

Clampable conductor	Cross-section for conductor connection	Type	fine-wired
		nominal	0.5 mm ²
wire end ferrule		Stripping length	nominal 14 mm
		Recommended wire-end ferrule	H0.5/18 OR
Clampable conductor	Cross-section for conductor connection	Type	fine-wired
		nominal	1 mm ²
wire end ferrule		Stripping length	nominal 15 mm
		Recommended wire-end ferrule	H1.0/18 GE
Clampable conductor	Cross-section for conductor connection	Type	fine-wired
		nominal	1.5 mm ²
wire end ferrule		Stripping length	nominal 15 mm
		Recommended wire-end ferrule	H1.5/18D SW
		Stripping length	nominal 12 mm
		Recommended wire-end ferrule	H1.5/12
Clampable conductor	Cross-section for conductor connection	Type	fine-wired
		nominal	0.75 mm ²
wire end ferrule		Stripping length	nominal 14 mm
		Recommended wire-end ferrule	H0.75/18 W
Clampable conductor	Cross-section for conductor connection	Type	fine-wired
		nominal	2.5 mm ²
wire end ferrule		Stripping length	nominal 14 mm
		Recommended wire-end ferrule	H2.5/19D BL
		Stripping length	nominal 12 mm
		Recommended wire-end ferrule	H2.5/12
Clampable conductor	Cross-section for conductor connection	Type	fine-wired
		nominal	4 mm ²
wire end ferrule		Stripping length	nominal 12 mm
		Recommended wire-end ferrule	H4.0/12
		Stripping length	nominal 14 mm
		Recommended wire-end ferrule	H4.0/20D GR
Clampable conductor	Cross-section for conductor connection	Type	fine-wired
		nominal	6 mm ²
wire end ferrule		Stripping length	nominal 14 mm
		Recommended wire-end ferrule	H6.0/20 SW
		Stripping length	nominal 12 mm
		Recommended wire-end ferrule	H6.0/12

Reference text The outside diameter of the plastic collar should not be larger than the pitch (P). Length of ferrules is to be chosen depending on the product and the rated voltage.

Rated data acc. to IEC

tested acc. to standard	IEC 60664-1, IEC 61984	Rated current, min. number of poles (Tu=20°C)	57 A
Rated current, max. number of poles (Tu=20°C)	54 A	Rated current, min. number of poles (Tu=40°C)	51 A

BVZ 7.62HP/02/180FC SN BK BX SO

Weidmüller Interface GmbH & Co. KG
 Klingenbergstraße 26
 D-32758 Detmold
 Germany

www.weidmueller.com

Technical data

Rated current, max. number of poles (Tu=40°C)	41 A	Rated voltage for surge voltage class / pollution degree II/2	1000 V
Rated voltage for surge voltage class / pollution degree III/2	1000 V	Rated voltage for surge voltage class / pollution degree III/3	800 V
Rated impulse voltage for surge voltage class/ pollution degree II/2	6000 V	Rated impulse voltage for surge voltage class/ pollution degree III/2	8 kV
Rated impulse voltage for surge voltage class/ contamination degree III/3	8 kV	Short-time withstand current resistance	3 x 1s with 420 A
Creepage distance, min.	13.8 mm	Clearance, min.	10.2 mm

Rated data acc. to CSA

Rated voltage (Use group B / CSA)	600 V	Rated voltage (Use group C / CSA)	600 V
Rated voltage (Use group D / CSA)	600 V	Rated current (Use group B / CSA)	40.5 A
Rated current (Use group C / CSA)	40.5 A	Rated current (Use group D / CSA)	5 A
Wire cross-section, AWG, min.	AWG 24	Wire cross-section, AWG, max.	AWG 8

Rated data acc. to UL 1059

Institute (cURus)	CURUS	Certificate No. (cURus)	E60693
Rated voltage (Use group B / UL 1059)	600 V	Rated voltage (Use group C / UL 1059)	600 V
Rated voltage (Use group D / UL 1059)	600 V	Rated voltage (Use group F / UL 1059)	1000 V
Rated current (Use group B / UL 1059)	40.5 A	Rated current (Use group C / UL 1059)	40.5 A
Rated current (Use group F / UL 1059)	40.5 A	Wire cross-section, AWG, max.	AWG 8
Reference to approval values	Specifications are maximum values, details - see approval certificate.		

Packing

Packaging	Box	VPE length	352.00 mm
VPE width	135.00 mm	VPE height	48.00 mm

Important note

IPC conformity	Conformity: The products are developed, manufactured and delivered according international recognized standards and norms and comply with the assured properties in the data sheet resp. fulfill decorative properties in accordance with IPC-A-610 "Class 2". Further claims on the products can be evaluated on request.
Notes	<ul style="list-style-type: none"> • Additional variants on request • Rated current related to rated cross-section & min. No. of poles. • Wire end ferrule with plastic collar to DIN 46228/4 • Wire end ferrule without plastic collar to DIN 46228/1 • P on drawing = pitch • Rated data refer only to the component itself. Clearance and creepage distances to other components are to be designed in accordance with the relevant application standards. • In accordance with IEC 61984, OMNIMATE-connectors are connectors without breaking capacity (COC). During designated use, connectors are not allowed to be engaged or disengaged when live or under load • Long term storage of the product with average temperature of 50 °C and maximum humidity 70%, 36 months

Classifications

ETIM 8.0	EC002638	ETIM 9.0	EC002638
ETIM 10.0	EC002638	ECLASS 14.0	27-46-02-02
ECLASS 15.0	27-46-02-02		

BVZ 7.62HP/02/180FC SN BK BX SO

Weidmüller Interface GmbH & Co. KG
 Klingenbergstraße 26
 D-32758 Detmold
 Germany

www.weidmueller.com

Drawings

Product image



Dimensional drawing

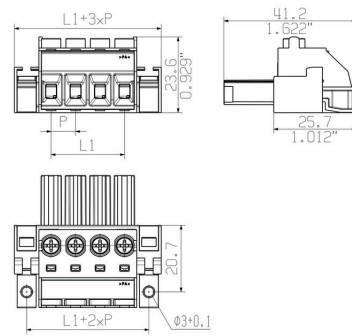

Graph

