

ALFS 4 2C 60-150V BK**Weidmüller Interface GmbH & Co. KG**

Klingenbergstraße 26

D-32758 Detmold

Germany

www.weidmueller.com

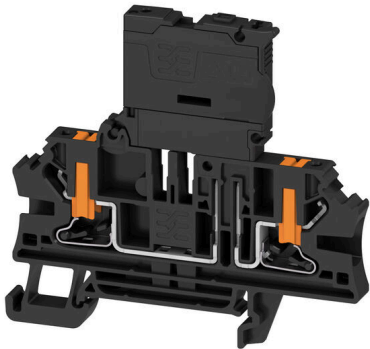

Fuse terminal blocks and component terminal blocks allow protective and functional elements to be integrated directly into the terminal strip. Fuse terminal blocks include built-in fuse holders to reliably protect electrical circuits against overload –ideal for control and distribution systems. Component terminal blocks make it possible to incorporate electronic components such as diodes, resistors, or LEDs directly into the wiring. This enables space-saving and clearly arranged implementation of switching functions and signal separation. Both types of terminal blocks ensure higher safety, easy maintenance, and a compact, function-oriented installation.

General ordering data

Version	Fuse terminal, PUSH IN, black, 4 mm ² , 6.3 A, 150 V, Number of connections: 2, Number of levels: 1, TS 35
Order No.	2898810000
Type	ALFS 4 2C 60-150V BK
GTIN (EAN)	4064675904410
Qty.	50 items

ALFS 4 2C 60-150V BK

Weidmüller Interface GmbH & Co. KG
Klingenbergstraße 26
D-32758 Detmold
Germany

www.weidmueller.com

Technical data

Approvals

Approvals



ROHS	Conform
UL File Number Search	UL Website
Certificate No. (cURus)	E0693VOL1SEC137

Dimensions and weights

Depth	68 mm	Depth (inches)	2.6772 inch
Height	73.5 mm	Height (inches)	2.8937 inch
Width	6.1 mm	Width (inches)	0.2402 inch
Net weight	15.63 g		

Temperatures

Storage temperature	-25 °C...55 °C	Continuous operating temp., min.	-60 °C
Continuous operating temp., max.	130 °C		

Environmental Product Compliance

RoHS Compliance Status	Compliant without exemption
REACH SVHC	No SVHC above 0.1 wt%

Material data

Basic material	Wemid	Colour	black
Colour of operational elements	orange	UL 94 flammability rating	V-0

Rating data IECEx/ATEX

Certificate No. (ATEX)	TUEV24ATEX9181U	Certificate No. (IECEX)	IEXEXTUR24.0066U
Max. voltage (ATEX)	150 V	Current (ATEX)	6.3 A
Wire cross section max. (ATEX)	6 mm ²	Max. voltage (IECEX)	150 V
Current (IECEX)	6.3 A	Wire cross section max. (IECEX)	6 mm ²

System specifications

End cover plate required	Yes	Number of potentials	1
Number of levels	1	Number of clamping points per level	2
Number of potentials per tier	1	Levels cross-connected internally	No
Mounting rail	TS 35	N-function	No
PE function	No	PEN function	No

Additional technical data

Open sides	right	Snap-on	Yes
Type of mounting	Snap-on		

CSA rating data

Wire cross section max. (CSA)	10 AWG	Voltage size C (CSA)	150 V
Current size C (CSA)	10 A	Certificate No. (CSA)	227442-80177078

ALFS 4 2C 60-150V BK

Weidmüller Interface GmbH & Co. KG

Klingenbergstraße 26

D-32758 Detmold

Germany

www.weidmueller.com

Technical data

Voltage size B (CSA)	300 V	Current size B (CSA)	10 A
Voltage size D (CSA)	300 V	Current size D (CSA)	10 A
Wire cross section min. (CSA)	24 AWG		

Conductors for clamping (additional connection)

Connection type, additional connection PUSH IN

Conductors for clamping (rated connection)

Gauge to IEC 60947-1	A4	Wire connection cross section AWG, max.	AWG 10
Connection direction	on side	Stripping length	12 mm
Type of connection 2	PUSH IN	Type of connection	PUSH IN
Number of connections	2	Clamping range, max.	6 mm ²
Clamping range, min.	0.14 mm ²	Blade size	0.6 x 3.5 mm
Wire connection cross section AWG, min.	AWG 26	Wire connection cross-section, finely stranded with wire-end ferrules DIN 46228/4, max.	4 mm ²
Wire connection cross-section, finely stranded with wire-end ferrules DIN 46228/4, min.	0.14 mm ²	Wire connection cross-section, finely stranded with wire-end ferrules DIN 46228/1, max.	4 mm ²
Wire connection cross-section, finely stranded with wire-end ferrules DIN 46228/1, min.	0.14 mm ²	Wire connection cross section, finely stranded, max.	6 mm ²
Wire connection cross section, finely stranded, min.	0.14 mm ²	Connection cross-section, stranded, max.	6 mm ²
Connection cross-section, stranded, min.	0.14 mm ²	Wire connection cross-section, solid core, max.	6 mm ²
Wire connection cross-section, solid core, min.	0.14 mm ²	Connection cross-section, finely stranded, min.	0.14 mm ²

Fuse terminals

Cartridge fuse	G-Si. 5 x 20	Fuse holder (cartridge holder)	Pivoting
Type of voltage for indicator	AC/DC	Display	LED
Operating voltage, max.	150 V		

General

Wire connection cross section AWG, max.	AWG 10	Wire connection cross section AWG, min.	AWG 26
Standards	IEC 60947-7-3	Mounting rail	TS 35

Rating data

Rated cross-section	4 mm ²	Rated voltage	150 V
Rated voltage to adjoining terminal	500 V	Rated DC voltage	150 V
Nominal current	6.3 A	Current at maximum wires	6.3 A
Standards	IEC 60947-7-3	Rated impulse withstand voltage	4 kV
Surge voltage category	III	Pollution severity	3

UL rating data

Conductor size Factory wiring max. (cURus)	10 AWG	Voltage size B (cURus)	300 V
Voltage size D (cURus)	300 V	Certificate No. (cURus)	E0693VOL1SEC137
Conductor size Field wiring min. (cURus)	24 AWG	Conductor size Factory wiring min. (cURus)	24 AWG
Current size B (cURus)	10 A	Voltage size C (cURus)	150 V

ALFS 4 2C 60-150V BK

Weidmüller Interface GmbH & Co. KG
Klingenbergstraße 26
D-32758 Detmold
Germany

www.weidmueller.com

Technical data

Current size C (cURus)	10 A	Current size D (cURus)	10 A
Conductor size Field wiring max. (cURus) 10 AWG			

Classifications

ETIM 8.0	EC000899	ETIM 9.0	EC000899
ETIM 10.0	EC000899	ECLASS 14.0	27-25-01-13
ECLASS 15.0	27-25-01-13		

Drawings

