

W2C 4 FS 30-70V BK**Weidmüller Interface GmbH & Co. KG**

Klingenbergstraße 26

D-32758 Detmold

Germany

www.weidmueller.com

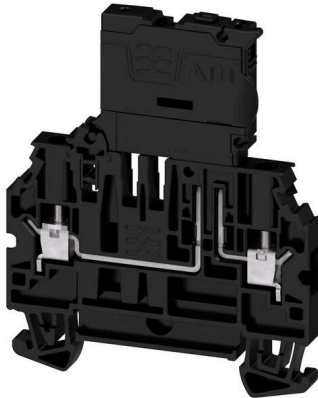

Automation in the process industry requires flexible solutions for complex production processes. Your circuit diagrams are no less complex and often undergo changes shortly before the end. With our new range of DCS marshalling terminal blocks you can solve these challenges. Even a „last minute change“ is feasible for you without having to change the wiring you have already done. Thanks to the single and double-level arrangement of the terminal blocks, combined with the provision of the four basic functions (continuity, disconnect, fuse, ground), you achieve maximum flexibility when connecting your devices wired in the field. We also offer you an alternative to connecting the shield to PE for your potential-free shielding concepts.

General ordering data

Version	Fuse terminal, Screw connection, black, 4 mm ² , 6.3 A, 70 V, Number of connections: 2, Number of levels: 1, TS 35
Order No.	2893030000
Type	W2C 4 FS 30-70V BK
GTIN (EAN)	4064675884613
Qty.	50 items

W2C 4 FS 30-70V BK

Weidmüller Interface GmbH & Co. KG
Klingenbergstraße 26
D-32758 Detmold
Germany

www.weidmueller.com

Technical data

Approvals

Approvals



ROHS	Conform
UL File Number Search	UL Website
Certificate No. (cURus)	E60693

Dimensions and weights

Depth	75 mm	Depth (inches)	2.9527 inch
Height	60 mm	Height (inches)	2.3622 inch
Width	6.1 mm	Width (inches)	0.2402 inch
Net weight	18.32 g		

Temperatures

Ambient temperature	-60 °C...85 °C	Continuous operating temp., min.	-60 °C
Continuous operating temp., max.	130 °C		

Environmental Product Compliance

RoHS Compliance Status	Compliant without exemption
REACH SVHC	No SVHC above 0.1 wt%

Material data

Basic material	Wemid	Colour	black
UL 94 flammability rating	V-0		

Rating data IECEx/ATEX

Certificate No. (ATEX)	TUEV20ATEX8502U	Certificate No. (IECEX)	IECEXTUR20.0014U
Current (ATEX)	6.3 A	Wire cross section max. (ATEX)	4 mm ²
Current (IECEX)	6.3 A	Wire cross section max. (IECEX)	4 mm ²

System specifications

End cover plate required	Yes	Number of potentials	1
Number of levels	1	Number of clamping points per level	2
Number of potentials per tier	1	Levels cross-connected internally	No
Mounting rail	TS 35	N-function	No
PE function	No	PEN function	No

Additional technical data

Open sides	right	Snap-on	Yes
Installation advice	TS 35	Explosion-tested version	No
Type of mounting	TS 35		

W2C 4 FS 30-70V BK

Weidmüller Interface GmbH & Co. KG

Klingenbergstraße 26
D-32758 Detmold
Germany

www.weidmueller.com

Technical data

CSA rating data

Wire cross section max. (CSA)	12 AWG	Voltage size C (CSA)	300 V
Current size C (CSA)	10 A	Certificate No. (CSA)	227442-80219640
Voltage size B (CSA)	300 V	Current size B (CSA)	10 A
Voltage size D (CSA)	600 V	Current size D (CSA)	5 A
Wire cross section min. (CSA)	24 AWG		

Conductors for clamping (additional connection)

Connection type, additional connection Screw connection

Conductors for clamping (rated connection)

Gauge to IEC 60947-1	A3	Wire connection cross section AWG, max.	AWG 10
Connection direction	on side	Tightening torque, max.	0.8 Nm
Tightening torque, min.	0.5 Nm	Stripping length	8 mm
Type of connection 2	Screw connection	Type of connection	Screw connection
Number of connections	2	Clamping range, max.	6 mm ²
Clamping range, min.	0.25 mm ²	Clamping screw	M 3
Blade size	0.6 x 3.5 mm	Wire connection cross section AWG, min.	AWG 24
Wire connection cross-section, finely stranded with wire-end ferrules DIN 46228/4, max.	4 mm ²	Wire connection cross-section, finely stranded with wire-end ferrules DIN 46228/4, min.	0.25 mm ²
Wire connection cross-section, finely stranded with wire-end ferrules DIN 46228/1, max.	4 mm ²	Wire connection cross-section, finely stranded with wire-end ferrules DIN 46228/1, min.	0.25 mm ²
Wire connection cross section, finely stranded, max.	6 mm ²	Wire connection cross section, finely stranded, min.	0.25 mm ²
Connection cross-section, stranded, max.	6 mm ²	Connection cross-section, stranded, min.	0.25 mm ²
Twin wire-end ferrules, max.	1.5 mm ²	Twin wire-end ferrules, min.	0.5 mm ²
Wire connection cross-section, solid core, max.	6 mm ²	Wire connection cross-section, solid core, min.	0.25 mm ²
Connection cross-section, finely stranded, min.	0.25 mm ²		

General

Wire connection cross section AWG, max.	AWG 10	Installation advice	TS 35
Wire connection cross section AWG, min.	AWG 24	Standards	IEC 60947-7-3
Mounting rail	TS 35		

Rating data

Rated cross-section	4 mm ²	Rated voltage	70 V
Rated DC voltage	70 V	Nominal current	6.3 A
Current at maximum wires	6.3 A	Standards	IEC 60947-7-3
Volume resistance according to IEC 60947-7-x	1 mΩ	Rated impulse withstand voltage	6 kV
Surge voltage category	III	Pollution severity	3

W2C 4 FS 30-70V BK

Weidmüller Interface GmbH & Co. KG
 Klingenbergstraße 26
 D-32758 Detmold
 Germany

www.weidmueller.com

Technical data

UL rating data

Conductor size Factory wiring max. (cURus)	12 AWG	Certificate No. (cURus)	E60693
Conductor size Field wiring min. (cURus)	24 AWG	Conductor size Factory wiring min. (cURus)	24 AWG
Conductor size Field wiring max. (cURus)	12 AWG		

Important note

Product information The voltage depends on the selected fuse element or the selected indicator light

Classifications

ETIM 8.0	EC000899	ETIM 9.0	EC000899
ETIM 10.0	EC000899	ECLASS 14.0	27-25-01-13
ECLASS 15.0	27-25-01-13		

Drawings

