

W2C 4 DT-PE**Weidmüller Interface GmbH & Co. KG**Klingenbergstraße 26
D-32758 Detmold
Germany

www.weidmueller.com

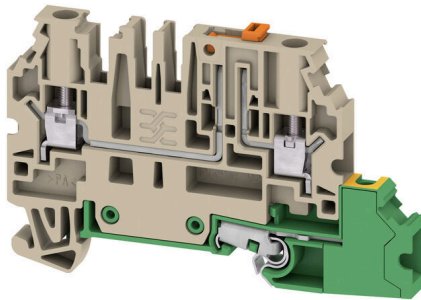

Automation in the process industry requires flexible solutions for complex production processes. Your circuit diagrams are no less complex and often undergo changes shortly before the end. With our new range of DCS marshalling terminal blocks you can solve these challenges. Even a „last minute change“ is feasible for you without having to change the wiring you have already done. Thanks to the single and double-level arrangement of the terminal blocks, combined with the provision of the four basic functions (continuity, disconnect, fuse, ground), you achieve maximum flexibility when connecting your devices wired in the field. We also offer you an alternative to connecting the shield to PE for your potential-free shielding concepts.

General ordering data

Version	Test-disconnect terminal, Screw connection, dark beige, 4 mm ² , 28 A, 500 V, Number of connections: 3, Number of levels: 2
Order No.	2892810000
Type	W2C 4 DT-PE
GTIN (EAN)	4064675884460
Qty.	50 items

W2C 4 DT-PE

Weidmüller Interface GmbH & Co. KG
Klingenbergstraße 26
D-32758 Detmold
Germany

www.weidmueller.com

Technical data

Approvals

Approvals



ROHS	Conform
UL File Number Search	UL Website
Certificate No. (cURus)	E60693
Certificate No. (cURusEX)	E184763

Dimensions and weights

Depth	48 mm	Depth (inches)	1.8898 inch
Height	72.5 mm	Height (inches)	2.8543 inch
Width	6.1 mm	Width (inches)	0.2402 inch
Net weight	15.88 g		

Temperatures

Ambient temperature	-60 °C...85 °C	Continuous operating temp., min.	-60 °C
Continuous operating temp., max.	130 °C		

Environmental Product Compliance

RoHS Compliance Status	Compliant without exemption
REACH SVHC	No SVHC above 0.1 wt%

Material data

Basic material	Wemid	Colour	dark beige
Colour of operational elements	orange	UL 94 flammability rating	V-0

Rating data IECEX/ATEX

Certificate No. (ATEX)	TUEV20ATEX8502U	Certificate No. (IECEX)	IECEXTUR20.0014U
Max. voltage (ATEX)	550 V	Current (ATEX)	26 A
Wire cross section max. (ATEX)	4 mm ²	Max. voltage (IECEX)	550 V
Current (IECEX)	26 A	Wire cross section max. (IECEX)	4 mm ²

System specifications

End cover plate required	Yes	Number of potentials	1
Number of levels	2	Number of clamping points per level	2
Number of potentials per tier	1	Levels cross-connected internally	No
Mounting rail	TS 35	N-function	No
PE function	Yes	PEN function	No

Additional technical data

Open sides	right	Snap-on	Yes
Explosion-tested version	No	Type of mounting	TS 35

W2C 4 DT-PE

Weidmüller Interface GmbH & Co. KG

Klingenbergstraße 26

D-32758 Detmold

Germany

www.weidmueller.com

Technical data

CSA rating data

Wire cross section max. (CSA)	12 AWG	Voltage size C (CSA)	300 V
Current size C (CSA)	20 A	Certificate No. (CSA)	227442-80219640
Voltage size B (CSA)	300 V	Current size B (CSA)	20 A
Voltage size D (CSA)	600 V	Current size D (CSA)	5 A
Wire cross section min. (CSA)	24 AWG		

Conductors for clamping (additional connection)

Connection type, additional connection Screw connection

Conductors for clamping (rated connection)

Gauge to IEC 60947-1	A3	Wire connection cross section AWG, max.	AWG 10
Connection direction	on side	Tightening torque, max.	0.8 Nm
Tightening torque, min.	0.5 Nm	Stripping length	8 mm
Type of connection 2	Screw connection	Type of connection	Screw connection
Number of connections	3	Clamping range, max.	6 mm ²
Clamping range, min.	0.25 mm ²	Clamping screw	M 3
Blade size	0.6 x 3.5 mm	Wire connection cross section AWG, min.	AWG 24
Wire connection cross-section, finely stranded with wire-end ferrules DIN 46228/4, max.	4 mm ²	Wire connection cross-section, finely stranded with wire-end ferrules DIN 46228/4, min.	0.25 mm ²
Wire connection cross-section, finely stranded with wire-end ferrules DIN 46228/1, max.	4 mm ²	Wire connection cross-section, finely stranded with wire-end ferrules DIN 46228/1, min.	0.25 mm ²
Wire connection cross section, finely stranded, max.	6 mm ²	Wire connection cross section, finely stranded, min.	0.25 mm ²
Connection cross-section, stranded, max.	6 mm ²	Connection cross-section, stranded, min.	0.25 mm ²
Twin wire-end ferrules, max.	1.5 mm ²	Twin wire-end ferrules, min.	0.5 mm ²
Wire connection cross-section, solid core, max.	6 mm ²	Wire connection cross-section, solid core, min.	0.25 mm ²
Connection cross-section, finely stranded, min.	0.25 mm ²		

General

Wire connection cross section AWG, max.	AWG 10	Wire connection cross section AWG, min.	AWG 24
Standards	IEC 60947-7-1, IEC 60947-7-2	Mounting rail	TS 35

Rating data

Rated cross-section	4 mm ²	Rated voltage	500 V
Rated DC voltage	500 V	Nominal current	28 A
Current at maximum wires	28 A	Standards	IEC 60947-7-1, IEC 60947-7-2
Volume resistance according to IEC 60947-7-x	1 mΩ	Rated impulse withstand voltage	6 kV
Surge voltage category	III	Pollution severity	3

W2C 4 DT-PE

Weidmüller Interface GmbH & Co. KG
Klingenbergstraße 26
D-32758 Detmold
Germany

www.weidmueller.com

Technical data**UL rating data**

Conductor size Factory wiring max. (cURus)	12 AWG	Certificate No. (cURus)	E60693
Conductor size Field wiring min. (cURus)	24 AWG	Conductor size Factory wiring min. (cURus)	24 AWG
Conductor size Field wiring max. (cURus)	12 AWG		

Classifications

ETIM 8.0	EC000902	ETIM 9.0	EC000902
ETIM 10.0	EC000902	ECLASS 14.0	27-25-01-09
ECLASS 15.0	27-25-01-09		

Drawings

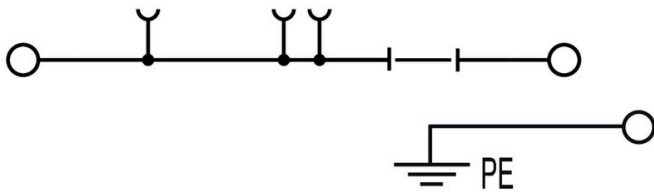

W2C 4 DT-PE

Weidmüller Interface GmbH & Co. KG

Klingenbergstraße 26

D-32758 Detmold

Germany

Accessories

www.weidmueller.com

Cross-connections



The distribution or multiplication of a potential to adjoining terminal blocks is realized via a cross-connection. Additional wiring effort can be easily avoided. Even if the poles are broken out, contact reliability in the terminal blocks is still ensured. Our portfolio offers pluggable and screwable cross-connection systems for modular terminal blocks.

General ordering data

Type	ZQV 4N/10	Version
Order No.	1528090000	Cross-connector (terminal), Plugged, orange, 32 A, Number of poles:
GTIN (EAN)	4050118332896	10, Pitch in mm (P): 6.10, Insulated: Yes, Width: 58.7 mm
Qty.	20 ST	
Type	ZQV 4N/10 BK	Version
Order No.	2810830000	Cross-connector (terminal), Plugged, black, 32 A, Number of poles:
GTIN (EAN)	4064675283447	10, Pitch in mm (P): 6.10, Insulated: Yes, Width: 58.7 mm
Qty.	20 ST	
Type	ZQV 4N/10 BL	Version
Order No.	1528230000	Cross-connector (terminal), Plugged, blue, 32 A, Number of poles: 10,
GTIN (EAN)	4050118333138	Pitch in mm (P): 6.10, Insulated: Yes, Width: 58.7 mm
Qty.	20 ST	
Type	ZQV 4N/10 RD	Version
Order No.	2460740000	Cross-connector (terminal), Plugged, red, 32 A, Number of poles: 10,
GTIN (EAN)	4050118476163	Pitch in mm (P): 6.10, Insulated: Yes, Width: 58.7 mm
Qty.	20 ST	
Type	ZQV 4N/10 WT	Version
Order No.	2831790000	Cross-connector (terminal), Plugged, white, 32 A, Number of poles:
GTIN (EAN)	4064675417026	10, Pitch in mm (P): 6.10, Insulated: Yes, Width: 58.7 mm
Qty.	20 ST	
Type	ZQV 4N/2	Version
Order No.	1527930000	Cross-connector (terminal), Plugged, orange, 32 A, Number of poles:
GTIN (EAN)	4050118332766	2, Pitch in mm (P): 6.10, Insulated: Yes, Width: 9.9 mm
Qty.	60 ST	
Type	ZQV 4N/2 BK	Version
Order No.	2810840000	Cross-connector (terminal), Plugged, black, 32 A, Number of poles: 2,
GTIN (EAN)	4064675283454	Pitch in mm (P): 6.10, Insulated: Yes, Width: 9.9 mm
Qty.	60 ST	
Type	ZQV 4N/2 BL	Version
Order No.	1528040000	Cross-connector (terminal), Plugged, blue, 32 A, Number of poles: 2,
GTIN (EAN)	4050118332773	Pitch in mm (P): 6.10, Insulated: Yes, Width: 9.9 mm
Qty.	60 ST	
Type	ZQV 4N/2 RD	Version
Order No.	2460450000	Cross-connector (terminal), Plugged, red, 32 A, Number of poles: 2,
GTIN (EAN)	4050118476149	Pitch in mm (P): 6.10, Insulated: Yes, Width: 9.9 mm
Qty.	60 ST	
Type	ZQV 4N/2 WT	Version
Order No.	2831800000	Cross-connector (terminal), Plugged, white, 32 A, Number of poles: 2,
GTIN (EAN)	4064675417033	Pitch in mm (P): 6.10, Insulated: Yes, Width: 119.7 mm
Qty.	60 ST	

W2C 4 DT-PE

Weidmüller Interface GmbH & Co. KG

Klingenbergstraße 26
D-32758 Detmold
Germany

www.weidmueller.com

Accessories

Type	ZQV 4N/20	Version
Order No.	2883800000	Cross-connector (terminal), Plugged, orange, 32 A, Number of poles:
GTIN (EAN)	4064675848769	20, Pitch in mm (P): 6.10, Insulated: Yes, Width: 27.95 mm
Qty.	20 ST	
Type	ZQV 4N/20 BK	Version
Order No.	2810870000	Cross-connector (terminal), Plugged, black, 32 A, Number of poles:
GTIN (EAN)	4064675283485	20, Pitch in mm (P): 6.10, Insulated: Yes, Width: 27.95 mm
Qty.	20 ST	
Type	ZQV 4N/20 BL	Version
Order No.	2810850000	Cross-connector (terminal), Plugged, blue, 32 A, Number of poles: 10,
GTIN (EAN)	4064675283461	Pitch in mm (P): 6.10, Insulated: Yes, Width: 119.7 mm
Qty.	20 ST	
Type	ZQV 4N/20 RD	Version
Order No.	2810860000	Cross-connector (terminal), Plugged, red, 32 A, Number of poles: 20,
GTIN (EAN)	4064675283478	Pitch in mm (P): 6.10, Insulated: Yes, Width: 27.95 mm
Qty.	20 ST	
Type	ZQV 4N/3	Version
Order No.	1527940000	Cross-connector (terminal), Plugged, orange, 32 A, Number of poles:
GTIN (EAN)	4050118332865	3, Pitch in mm (P): 6.10, Insulated: Yes, Width: 16 mm
Qty.	60 ST	
Type	ZQV 4N/3 BK	Version
Order No.	2810880000	Cross-connector (terminal), Plugged, black, 32 A, Number of poles: 3,
GTIN (EAN)	4064675283492	Pitch in mm (P): 6.10, Insulated: Yes, Width: 27.95 mm
Qty.	60 ST	
Type	ZQV 4N/3 BL	Version
Order No.	1528080000	Cross-connector (terminal), Plugged, blue, 32 A, Number of poles: 3,
GTIN (EAN)	4050118333008	Pitch in mm (P): 6.10, Insulated: Yes, Width: 16 mm
Qty.	60 ST	
Type	ZQV 4N/3 RD	Version
Order No.	2460810000	Cross-connector (terminal), Plugged, red, 32 A, Number of poles: 3,
GTIN (EAN)	4050118476231	Pitch in mm (P): 6.10, Insulated: Yes, Width: 16 mm
Qty.	60 ST	
Type	ZQV 4N/3 WT	Version
Order No.	2831810000	Cross-connector (terminal), Plugged, white, 32 A, Number of poles: 3,
GTIN (EAN)	4064675417040	Pitch in mm (P): 6.10, Insulated: Yes, Width: 247.8 mm
Qty.	60 ST	
Type	ZQV 4N/30	Version
Order No.	2561580000	Cross-connector (terminal), Plugged, orange, 32 A, Number of poles:
GTIN (EAN)	4050118570113	30, Pitch in mm (P): 6.10, Insulated: Yes, Width: 181.7 mm
Qty.	5 ST	
Type	ZQV 4N/30 BL	Version
Order No.	2561610000	Cross-connector (terminal), Plugged, blue, 32 A, Number of poles: 30,
GTIN (EAN)	4050118569971	Pitch in mm (P): 6.10, Insulated: Yes, Width: 181.7 mm
Qty.	5 ST	
Type	ZQV 4N/30 RD	Version
Order No.	2561600000	Cross-connector (terminal), Plugged, red, 32 A, Number of poles: 30,
GTIN (EAN)	4050118569964	Pitch in mm (P): 6.10, Insulated: Yes, Width: 181.7 mm
Qty.	5 ST	
Type	ZQV 4N/32	Version
Order No.	2561670000	Cross-connector (terminal), Plugged, orange, 32 A, Number of poles:
GTIN (EAN)	4050118570175	32, Pitch in mm (P): 6.10, Insulated: Yes, Width: 193.9 mm
Qty.	5 ST	

W2C 4 DT-PE

Weidmüller Interface GmbH & Co. KG

Klingenbergstraße 26
D-32758 Detmold
Germany

www.weidmueller.com

Accessories

Type	ZQV 4N/4	Version
Order No.	1527970000	Cross-connector (terminal), Plugged, orange, 32 A, Number of poles:
GTIN (EAN)	4050118332889	4, Pitch in mm (P): 6.10, Insulated: Yes, Width: 22.1 mm
Qty.	60 ST	
Type	ZQV 4N/4 BK	Version
Order No.	2810890000	Cross-connector (terminal), Plugged, black, 32 A, Number of poles: 4,
GTIN (EAN)	4064675283607	Pitch in mm (P): 6.10, Insulated: Yes, Width: 27.95 mm
Qty.	60 ST	
Type	ZQV 4N/4 BL	Version
Order No.	1528120000	Cross-connector (terminal), Plugged, blue, 32 A, Number of poles: 4,
GTIN (EAN)	4050118332872	Pitch in mm (P): 6.10, Insulated: Yes, Width: 22.1 mm
Qty.	60 ST	
Type	ZQV 4N/4 RD	Version
Order No.	2460800000	Cross-connector (terminal), Plugged, red, 32 A, Number of poles: 4,
GTIN (EAN)	4050118476224	Pitch in mm (P): 6.10, Insulated: Yes, Width: 22.1 mm
Qty.	60 ST	
Type	ZQV 4N/4 WT	Version
Order No.	2831820000	Cross-connector (terminal), Plugged, white, 32 A, Number of poles: 4,
GTIN (EAN)	4064675417057	Pitch in mm (P): 6.10, Insulated: Yes, Width: 119.7 mm
Qty.	60 ST	
Type	ZQV 4N/41	Version
Order No.	2883810000	Cross-connector (terminal), Plugged, orange, 32 A, Number of poles:
GTIN (EAN)	4064675848844	41, Pitch in mm (P): 6.10, Insulated: Yes, Width: 253.9 mm
Qty.	10 ST	
Type	ZQV 4N/41 BK	Version
Order No.	2831890000	Cross-connector (terminal), Plugged, black, 32 A, Number of poles:
GTIN (EAN)	4064675417125	41, Pitch in mm (P): 6.10, Insulated: Yes, Width: 253.9 mm
Qty.	10 ST	
Type	ZQV 4N/41 BL	Version
Order No.	2883820000	Cross-connector (terminal), Plugged, blue, 32 A, Number of poles: 41,
GTIN (EAN)	4064675848851	Pitch in mm (P): 6.10, Insulated: Yes, Width: 253.9 mm
Qty.	10 ST	
Type	ZQV 4N/41 RD	Version
Order No.	2883840000	Cross-connector (terminal), Plugged, red, 32 A, Number of poles: 41,
GTIN (EAN)	4064675848868	Pitch in mm (P): 6.10, Insulated: Yes, Width: 253.9 mm
Qty.	10 ST	
Type	ZQV 4N/5	Version
Order No.	1527980000	Cross-connector (terminal), Plugged, orange, 32 A, Number of poles:
GTIN (EAN)	4050118332759	5, Pitch in mm (P): 6.10, Insulated: Yes, Width: 28.2 mm
Qty.	60 ST	
Type	ZQV 4N/5 BK	Version
Order No.	2810900000	Cross-connector (terminal), Plugged, black, 32 A, Number of poles: 5,
GTIN (EAN)	4064675283614	Pitch in mm (P): 6.10, Insulated: Yes, Width: 27.95 mm
Qty.	60 ST	
Type	ZQV 4N/5 BL	Version
Order No.	1528140000	Cross-connector (terminal), Plugged, blue, 32 A, Number of poles: 5,
GTIN (EAN)	4050118333015	Pitch in mm (P): 6.10, Insulated: Yes, Width: 28.2 mm
Qty.	60 ST	
Type	ZQV 4N/5 RD	Version
Order No.	2460790000	Cross-connector (terminal), Plugged, red, 32 A, Number of poles: 5,
GTIN (EAN)	4050118476217	Pitch in mm (P): 6.10, Insulated: Yes, Width: 28.2 mm
Qty.	60 ST	

W2C 4 DT-PE

Weidmüller Interface GmbH & Co. KG

Klingenbergstraße 26
D-32758 Detmold
Germany

www.weidmueller.com

Accessories

Type	ZQV 4N/5 WT	Version
Order No.	2831830000	Cross-connector (terminal), Plugged, white, 32 A, Number of poles:
GTIN (EAN)	4064675417064	41, Pitch in mm (P): 6.10, Insulated: Yes, Width: 247.8 mm
Qty.	60 ST	
Type	ZQV 4N/50	Version
Order No.	1528130000	Cross-connector (terminal), Plugged, orange, 32 A, Number of poles:
GTIN (EAN)	4050118332902	50, Pitch in mm (P): 6.10, Insulated: Yes, Width: 303.7 mm
Qty.	5 ST	
Type	ZQV 4N/50 BL	Version
Order No.	1528240000	Cross-connector (terminal), Plugged, blue, 32 A, Number of poles: 50,
GTIN (EAN)	4050118333121	Pitch in mm (P): 6.10, Insulated: Yes, Width: 303.7 mm
Qty.	5 ST	
Type	ZQV 4N/50 RD	Version
Order No.	2460730000	Cross-connector (terminal), Plugged, red, 32 A, Number of poles: 50,
GTIN (EAN)	4050118476156	Pitch in mm (P): 6.10, Insulated: Yes, Width: 303.7 mm
Qty.	5 ST	
Type	ZQV 4N/6	Version
Order No.	1527990000	Cross-connector (terminal), Plugged, orange, 32 A, Number of poles:
GTIN (EAN)	4050118332919	6, Pitch in mm (P): 6.10, Insulated: Yes, Width: 34.3 mm
Qty.	20 ST	
Type	ZQV 4N/6 BK	Version
Order No.	2810910000	Cross-connector (terminal), Plugged, black, 32 A, Number of poles: 6,
GTIN (EAN)	4064675283621	Pitch in mm (P): 6.10, Insulated: Yes, Width: 27.95 mm
Qty.	20 ST	
Type	ZQV 4N/6 BL	Version
Order No.	1528170000	Cross-connector (terminal), Plugged, blue, 32 A, Number of poles: 6,
GTIN (EAN)	4050118332926	Pitch in mm (P): 6.10, Insulated: Yes, Width: 34.3 mm
Qty.	20 ST	
Type	ZQV 4N/6 RD	Version
Order No.	2460780000	Cross-connector (terminal), Plugged, red, 32 A, Number of poles: 6,
GTIN (EAN)	4050118476200	Pitch in mm (P): 6.10, Insulated: Yes, Width: 34.3 mm
Qty.	20 ST	
Type	ZQV 4N/6 WT	Version
Order No.	2831840000	Cross-connector (terminal), Plugged, white, 32 A, Number of poles: 2,
GTIN (EAN)	4064675417071	Pitch in mm (P): 6.10, Insulated: Yes, Width: 9.9 mm
Qty.	20 ST	
Type	ZQV 4N/7	Version
Order No.	1528020000	Cross-connector (terminal), Plugged, orange, 32 A, Number of poles:
GTIN (EAN)	4050118332780	7, Pitch in mm (P): 6.10, Insulated: Yes, Width: 40.4 mm
Qty.	20 ST	
Type	ZQV 4N/7 BK	Version
Order No.	2810920000	Cross-connector (terminal), Plugged, black, 32 A, Number of poles: 7,
GTIN (EAN)	4064675283638	Pitch in mm (P): 6.10, Insulated: Yes, Width: 27.95 mm
Qty.	20 ST	
Type	ZQV 4N/7 BL	Version
Order No.	1528180000	Cross-connector (terminal), Plugged, blue, 32 A, Number of poles: 7,
GTIN (EAN)	4050118333114	Pitch in mm (P): 6.10, Insulated: Yes, Width: 40.4 mm
Qty.	20 ST	
Type	ZQV 4N/7 RD	Version
Order No.	2460770000	Cross-connector (terminal), Plugged, red, 32 A, Number of poles: 7,
GTIN (EAN)	4050118476194	Pitch in mm (P): 6.10, Insulated: Yes, Width: 40.4 mm
Qty.	20 ST	

W2C 4 DT-PE

Weidmüller Interface GmbH & Co. KG

Klingenbergstraße 26

D-32758 Detmold

Germany

www.weidmueller.com

Accessories

Type	ZQV 4N/7 WT	Version
Order No.	2831850000	Cross-connector (terminal), Plugged, white, 32 A, Number of poles: 7,
GTIN (EAN)	4064675417088	Pitch in mm (P): 6.10, Insulated: Yes, Width: 16 mm
Qty.	20 ST	
Type	ZQV 4N/8	Version
Order No.	1528030000	Cross-connector (terminal), Plugged, orange, 32 A, Number of poles:
GTIN (EAN)	4050118332841	8, Pitch in mm (P): 6.10, Insulated: Yes, Width: 46.5 mm
Qty.	20 ST	
Type	ZQV 4N/8 BK	Version
Order No.	2810930000	Cross-connector (terminal), Plugged, black, 32 A, Number of poles: 8,
GTIN (EAN)	4064675283645	Pitch in mm (P): 6.10, Insulated: Yes, Width: 27.95 mm
Qty.	20 ST	
Type	ZQV 4N/8 BL	Version
Order No.	1528190000	Cross-connector (terminal), Plugged, blue, 32 A, Number of poles: 8,
GTIN (EAN)	4050118332858	Pitch in mm (P): 6.10, Insulated: Yes, Width: 46.5 mm
Qty.	20 ST	
Type	ZQV 4N/8 RD	Version
Order No.	2460760000	Cross-connector (terminal), Plugged, red, 32 A, Number of poles: 8,
GTIN (EAN)	4050118476187	Pitch in mm (P): 6.10, Insulated: Yes, Width: 46.5 mm
Qty.	20 ST	
Type	ZQV 4N/8 WT	Version
Order No.	2831860000	Cross-connector (terminal), Plugged, white, 32 A, Number of poles: 4,
GTIN (EAN)	4064675417095	Pitch in mm (P): 6.10, Insulated: Yes, Width: 22.1 mm
Qty.	20 ST	
Type	ZQV 4N/9	Version
Order No.	1528070000	Cross-connector (terminal), Plugged, orange, 32 A, Number of poles:
GTIN (EAN)	4050118332797	9, Pitch in mm (P): 6.10, Insulated: Yes, Width: 52.6 mm
Qty.	20 ST	
Type	ZQV 4N/9 BK	Version
Order No.	2831780000	Cross-connector (terminal), Plugged, black, 32 A, Number of poles:
GTIN (EAN)	4064675417019	20, Pitch in mm (P): 6.10, Insulated: Yes, Width: 119.7 mm
Qty.	20 ST	
Type	ZQV 4N/9 BL	Version
Order No.	1528220000	Cross-connector (terminal), Plugged, blue, 32 A, Number of poles: 9,
GTIN (EAN)	4050118333107	Pitch in mm (P): 6.10, Insulated: Yes, Width: 52.6 mm
Qty.	20 ST	
Type	ZQV 4N/9 RD	Version
Order No.	2460750000	Cross-connector (terminal), Plugged, red, 32 A, Number of poles: 9,
GTIN (EAN)	4050118476170	Pitch in mm (P): 6.10, Insulated: Yes, Width: 52.6 mm
Qty.	20 ST	
Type	ZQV 4N/9 WT	Version
Order No.	2831870000	Cross-connector (terminal), Plugged, white, 32 A, Number of poles:
GTIN (EAN)	4064675417101	10, Pitch in mm (P): 6.10, Insulated: Yes, Width: 58.7 mm
Qty.	20 ST	

W2C 4 DT-PE

Weidmüller Interface GmbH & Co. KG

Klingenbergstraße 26

D-32758 Detmold

Germany

www.weidmueller.com

Accessories

Accessories



The comprehensive accessories of the Klippon® Connect portfolio are perfectly matched down to the last detail. This facilitates mounting while adhering to required norms

General ordering data

Type	WEP 2C 4	Version
Order No.	2894210000	End plate for terminals, dark beige, Height: 60 mm, Width: 2 mm, V-0,
GTIN (EAN)	4064675885191	Wemid, Snap-on: Yes
Qty.	20 ST	
Type	WEP 2C 4 BK	Version
Order No.	2894230000	End plate for terminals, black, Height: 60 mm, Width: 2 mm, V-0,
GTIN (EAN)	4064675885214	Wemid, Snap-on: Yes
Qty.	20 ST	
Type	WEP 2C 4 BL	Version
Order No.	2894220000	End plate for terminals, blue, Height: 60 mm, Width: 2 mm, V-0,
GTIN (EAN)	4064675885207	Wemid, Snap-on: Yes
Qty.	20 ST	

End bracket

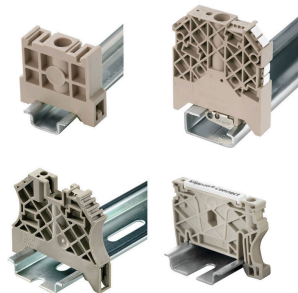

Weidmüller's range of products includes end brackets that guarantee a permanent, reliable mounting on the terminal rail and prevent sliding. Versions with and without screws are available. The end brackets include marking options, also for group markers, and also a test plug holder.

General ordering data

Type	WEW 35/2	Version
Order No.	1061200000	End bracket, dark beige, TS 35, HB, Wemid, Width: 8 mm, 100 °C
GTIN (EAN)	4008190030230	
Qty.	50 ST	
Type	WEW 35/2 GR	Version
Order No.	1859200000	End bracket, grey, TS 35, V-2, Wemid, Width: 8 mm, 100 °C
GTIN (EAN)	4032248411658	
Qty.	50 ST	
Type	WEW 35/2 SW	Version
Order No.	1061210000	End bracket, black, TS 35, V-2, Wemid, Width: 8 mm, 100 °C
GTIN (EAN)	4032248136278	
Qty.	50 ST	

W2C 4 DT-PE

Weidmüller Interface GmbH & Co. KG

Klingenbergstraße 26

D-32758 Detmold

Germany

www.weidmueller.com

Accessories

Slotted screwdriver



Slotted screwdriver with rounded blade SD DIN 5265, ISO 2380/2, output to DIN 5264, ISO 2380/1. ChromTop tip, SoftFinish grip

General ordering data

Type	SDS 0.6X3.5X100	Version	
Order No.	2749340000	Screwdriver, Blade width (B): 3.5 mm, Blade length: 100 mm, Blade thickness (A): 0.6 mm	
GTIN (EAN)	4050118895568		
Qty.	1 ST		

WS 8/6



WS/ DEK

MultiMark terminal markers use an innovative composite material made from two components. The hard base contour of the marker snaps securely into the connector. The elastic surface finish makes the marker easy to mount. This specially punched material enables the strips to be stretched to accommodate the slight variations in spacing that tend to add up, especially with long terminal blocks. Another advantage: the excellent printability of the surface material guarantees durable and wear-resistant labelling. A print resolution of 300 dpi also produces a very legible script.

Your benefits with MultiMark

- Firm hold and durable printing
- Continuous strips save installation time
- Easy mounting thanks to an innovative composite material
- Large label field for optimal legibility
- High flexibility thanks to manufacturer independence

General ordering data

Type	WS 8/6 MM WS	Version	
Order No.	2007160000	WS, Terminal marker, 8 x 6 mm, Weidmueller, white	
GTIN (EAN)	4050118391879		
Qty.	600 ST		

W2C 4 DT-PE

Weidmüller Interface GmbH & Co. KG

Klingenbergstraße 26

D-32758 Detmold

Germany

Accessories

www.weidmueller.com

DEK 5/6



WS/ DEK

MultiMark terminal markers use an innovative composite material made from two components. The hard base contour of the marker snaps securely into the connector. The elastic surface finish makes the marker easy to mount. This specially punched material enables the strips to be stretched to accommodate the slight variations in spacing that tend to add up, especially with long terminal blocks. Another advantage: the excellent printability of the surface material guarantees durable and wear-resistant labelling. A print resolution of 300 dpi also produces a very legible script.

Your benefits with MultiMark

- Firm hold and durable printing
- Continuous strips save installation time
- Easy mounting thanks to an innovative composite material
- Large label field for optimal legibility
- High flexibility thanks to manufacturer independence

General ordering data

Type	DEK 5/6 MM WS	Version	
Order No.	2007120000	Dekafix, Terminal marker, 5 x 6 mm, Weidmueller, white	
GTIN (EAN)	4050118392104		
Qty.	600 ST		

Plus



The Dekafix (DEK) marker is the universal marker for all conductor and plug-in connectors as well as for electronic sub-assemblies. The system is ideal for short number sequences and covers a wide range of ready-printed markers.

Strips for fast installation in only one work step. The printing is easy to read, rich in contrast and available in various widths.

- Large range of ready-to-use markers
 - Strips for fast installation
 - Terminal markers, suitable for all Weidmüller cable connectors
 - Available as blank MultiCard or with standard printing
- For custom printing: Please send us a file of our labeling software M-Print PRO or M-Print PRO Online (without installation) for your labeling specifications.

General ordering data

Type	DEK 5/6 PLUS MC NE WS	Version	
Order No.	1011320000	Dekafix, Terminal marker, 5 x 6 mm, Pitch in mm (P): 6.00	
GTIN (EAN)	4032248717644	Weidmueller, white	
Qty.	1000 ST		

W2C 4 DT-PE

Weidmüller Interface GmbH & Co. KG

Klingenbergstraße 26

D-32758 Detmold

Germany

www.weidmueller.com

Accessories

Blank



The Dekafix (DEK) marker is the universal marker for all conductor and plug-in connectors as well as for electronic sub-assemblies. The system is ideal for short number sequences and covers a wide range of ready-printed markers.

Strips for fast installation in only one work step. The printing is easy to read, rich in contrast and available in various widths.

- Large range of ready-to-use markers
 - Strips for fast installation
 - Terminal markers, suitable for all Weidmüller cable connectors
 - Available as blank MultiCard or with standard printing
- For custom printing: Please send us a file of our labeling software M-Print PRO or M-Print PRO Online (without installation) for your labeling specifications.

General ordering data

Type	DEK 5/5 MC NE WS	Version	
Order No.	1609801044	Dekafix, Terminal marker, 5 x 5 mm, Pitch in mm (P): 5.00	
GTIN (EAN)	4008190397111	Weidmueller, white	
Qty.	1000 ST		

Fuse holder



The fuse holder SIHA quickly turns a disconnect terminal into a fuse terminal: simply remove the disconnect lever and attach the fuse unit.

General ordering data

Type	SIHA 3/G20	Version	
Order No.	7921560000	Fuse holder for feed-through modular terminal, black, 6.3 A, pluggable, V-0, Wemid	
GTIN (EAN)	4032248264643		
Qty.	25 ST		
Type	SIHA 3/G20/LD 10-36V	Version	
Order No.	7921570000	Fuse holder for feed-through modular terminal, black, 2.31 mA, pluggable, V-0, Wemid	
GTIN (EAN)	4032248322503		
Qty.	25 ST		
Type	SIHA 3/G20/LD 35-70V	Version	
Order No.	7921580000	Fuse holder for feed-through modular terminal, black, 2.31 mA, pluggable, V-0, Wemid	
GTIN (EAN)	4032248322619		
Qty.	25 ST		
Type	SIHA 3/G20/LD 60-150V	Version	
Order No.	7921590000	Fuse holder for feed-through modular terminal, black, 2.31 mA, pluggable, V-0, Wemid	
GTIN (EAN)	4032248322626		
Qty.	25 ST		

W2C 4 DT-PE

Weidmüller Interface GmbH & Co. KG

Klingenbergstraße 26

D-32758 Detmold

Germany

www.weidmueller.com

Accessories

Type	SIHA 3/G20/LD 140-250V	Version	
Order No.	7921600000	Fuse holder for feed-through modular terminal, black, 2.31 mA,	
GTIN (EAN)	4032248322633	pluggable, V-0, Wemid	
Qty.	25 ST		

Disconnect plugs



In contrast to the terminal blocks with integrated disconnect lever, our disconnect plugs can be completely detached or removed from the terminal block and the respective application and offer a flexible alternative solution to our standard disconnectors.

General ordering data

Type	TNST OR	Version	
Order No.	2463540000	Disconnect plug (terminal), Wemid, orange	
GTIN (EAN)	4050118478211		
Qty.	50 ST		

Component plugs

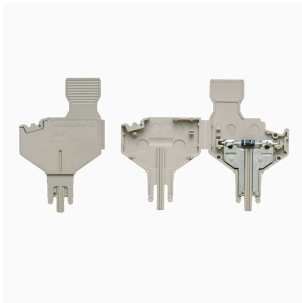

The component plug is used to integrate an electrical component in a disconnect terminal block. After soldering the electronic component, the plug can be integrated into the disconnection area of our disconnect terminal blocks and thus changes the disconnect terminal block into a modular terminal block with integrated electronic component.

General ordering data

Type	BEST	Version	
Order No.	1833100000	Accessories, Component plug	
GTIN (EAN)	4032248501014		
Qty.	50 ST		
Type	BEST/D	Version	
Order No.	1878560000	Accessories, Component plug, 1 A	
GTIN (EAN)	4032248471492		
Qty.	50 ST		
Type	BEST/DRBR	Version	
Order No.	1878570000	Accessories, Component plug, 22 A	
GTIN (EAN)	4032248471508		
Qty.	50 ST		

W2C 4 DT-PE

Weidmüller Interface GmbH & Co. KG
 Klingenbergstraße 26
 D-32758 Detmold
 Germany

www.weidmueller.com

Accessories

Accessories



The comprehensive accessories of the Klippon® Connect portfolio are perfectly matched down to the last detail. This facilitates mounting while adhering to required norms

General ordering data

Type	BZT W2C 4	Version	
Order No.	2894270000	Accessories holder (terminal), Wemid, dark beige	
GTIN (EAN)	4064675885252		
Qty.	20 ST		

Fuse holder



The fuse holder SIHA quickly turns a disconnect terminal into a fuse terminal: simply remove the disconnect lever and attach the fuse unit.

General ordering data

Type	FSPG LED 60-150V BL	Version	
Order No.	2869770000	Fuse holder for feed-through modular terminal, blue, 6.3 A, Pivoting,	
GTIN (EAN)	4064675623892	V-0, Wemid	
Qty.	25 ST		
Type	FSPG LED 60-150V BK	Version	
Order No.	2869720000	Fuse holder for feed-through modular terminal, black, 6.3 A, Pivoting,	
GTIN (EAN)	4064675623830	V-0, Wemid	
Qty.	25 ST		
Type	FSPG LED 30-70V BL	Version	
Order No.	2869760000	Fuse holder for feed-through modular terminal, blue, 6.3 A, Pivoting,	
GTIN (EAN)	4064675623885	V-0, Wemid	
Qty.	25 ST		
Type	FSPG LED 30-70V BK	Version	
Order No.	2869710000	Fuse holder for feed-through modular terminal, black, 6.3 A, Pivoting,	
GTIN (EAN)	4064675623823	V-0, Wemid	
Qty.	25 ST		
Type	FSPG LED 100-250V BL	Version	
Order No.	2869750000	Fuse holder for feed-through modular terminal, blue, 6.3 A, Pivoting,	
GTIN (EAN)	4064675623878	V-0, Wemid	
Qty.	25 ST		

W2C 4 DT-PE

Weidmüller Interface GmbH & Co. KG

Klingenbergstraße 26

D-32758 Detmold

Germany

www.weidmueller.com

Accessories

Type	FSPG LED 100-250V BK	Version
Order No.	2869700000	Fuse holder for feed-through modular terminal, black, 6.3 A, Pivoting,
GTIN (EAN)	4064675623816	V-0, Wemid
Qty.	25 ST	
Type	FSPG LED 10-36V BL	Version
Order No.	2869740000	Fuse holder for feed-through modular terminal, blue, 6.3 A, Pivoting,
GTIN (EAN)	4064675623861	V-0, Wemid
Qty.	25 ST	
Type	FSPG LED 10-36V BK	Version
Order No.	2869690000	Fuse holder for feed-through modular terminal, black, 6.3 A, Pivoting,
GTIN (EAN)	4064675623809	V-0, Wemid
Qty.	25 ST	
Type	FSPG BL	Version
Order No.	2869730000	Fuse holder for feed-through modular terminal, blue, 6.3 A, Pivoting,
GTIN (EAN)	4064675623854	V-0, Wemid
Qty.	25 ST	
Type	FSPG BK	Version
Order No.	2869680000	Fuse holder for feed-through modular terminal, black, 6.3 A, Pivoting,
GTIN (EAN)	4064675623793	V-0, Wemid
Qty.	25 ST	

Disconnect plugs



In contrast to the terminal blocks with integrated disconnect lever, our disconnect plugs can be completely detached or removed from the terminal block and the respective application and offer a flexible alternative solution to our standard disconnectors.

General ordering data

Type	TNHE ZDL2.5 OR VPE 100	Version
Order No.	2432480000	Disconnecting lever (terminal)
GTIN (EAN)	4050118443318	
Qty.	100 ST	

Marker holder



The marker holder offer the possibility of additional mounting of standard markers with a pitch of 5 or 5.1 mm. The angled holders can be optionally snapped together and could be mounted in all standard marking channels of the Klippon® Connect modular terminal blocks. Fitting marker types could be found under the respective accessories of the designation marking holder.

W2C 4 DT-PE

Weidmüller Interface GmbH & Co. KG

Klingenbergstraße 26

D-32758 Detmold

Germany

www.weidmueller.com

Accessories

General ordering data

Type	BZT 1 ZA WS 10/5	Version
Order No.	1805520000	Accessories, Marker holder
GTIN (EAN)	4032248270248	
Qty.	100 ST	
Type	BZT 1 WS 10/5	Version
Order No.	1805490000	Accessories, Marker holder
GTIN (EAN)	4032248270231	
Qty.	100 ST	

Blank

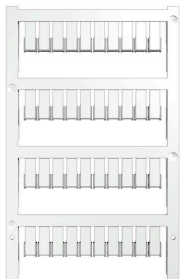

ZS markers - in proven MultiCard-format - have been developed specifically for the Z-series. They have a large printing area. The hinged mechanism even allows access to cross-connectors without dismantling. Quick installation is guaranteed by the fact that the single tags are clipped on in strips. The single tags are easy to separate.

- Hinged marker area
- Can be fitted in strips or individually
- Markers in proven MultiCard format

For custom printing: Please send us a file of our labeling software M-Print PRO or M-Print PRO Online (without installation) for your labeling specifications.

General ordering data

Type	ZS 12/6 MC NE WS	Version
Order No.	1610020000	ZS, Terminal marker, 12 x 6 mm, Pitch in mm (P): 6.00 Weidmueller,
GTIN (EAN)	4008190444600	Allen-Bradley, white
Qty.	400 ST	

Custom printing

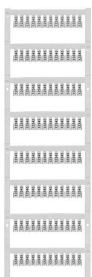

ZS markers - in proven MultiCard-format - have been developed specifically for the Z-series. They have a large printing area. The hinged mechanism even allows access to cross-connectors without dismantling. Quick installation is guaranteed by the fact that the single tags are clipped on in strips. The single tags are easy to separate.

- Hinged marker area
- Can be fitted in strips or individually
- Markers in proven MultiCard format

For custom printing: Please send us a file of our labeling software M-Print PRO or M-Print PRO Online (without installation) for your labeling specifications.

General ordering data

Type	ZS 12/6 MC SDR	Version
Order No.	1610030000	ZS, Terminal marker, 12 x 6 mm, Pitch in mm (P): 6.00 Weidmueller,
GTIN (EAN)	4008190456689	Allen-Bradley, To customer specification
Qty.	80 ST	

W2C 4 DT-PE

Weidmüller Interface GmbH & Co. KG

Klingenbergstraße 26

D-32758 Detmold

Germany

www.weidmueller.com

Accessories

Blank

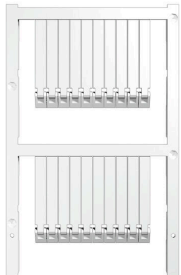

ZS markers - in proven MultiCard-format - have been developed specifically for the Z-series. They have a large printing area. The hinged mechanism even allows access to cross-connectors without dismantling. Quick installation is guaranteed by the fact that the single tags are clipped on in strips. The single tags are easy to separate.

- Hinged marker area
- Can be fitted in strips or individually
- Markers in proven MultiCard format

For custom printing: Please send us a file of our labeling software M-Print PRO or M-Print PRO Online (without installation) for your labeling specifications.

General ordering data

Type	ZS 30/5 MC NE WS	Version	
Order No.	2681880000	ZS, Terminal marker, 30 x 5 mm, Weidmueller, Allen-Bradley, white	
GTIN (EAN)	4050118803068		
Qty.	200 ST		

Custom printing



ZS markers - in proven MultiCard-format - have been developed specifically for the Z-series. They have a large printing area. The hinged mechanism even allows access to cross-connectors without dismantling. Quick installation is guaranteed by the fact that the single tags are clipped on in strips. The single tags are easy to separate.

- Hinged marker area
- Can be fitted in strips or individually
- Markers in proven MultiCard format

For custom printing: Please send us a file of our labeling software M-Print PRO or M-Print PRO Online (without installation) for your labeling specifications.

General ordering data

Type	ZS 30/5 MC SDR	Version	
Order No.	2682070000	ZS, Terminal marker, 30 x 5 mm, Weidmueller, Allen-Bradley, To customer specification	
GTIN (EAN)	4050118803075		
Qty.	40 ST		

Accessories



The comprehensive accessories of the Klippon® Connect portfolio are perfectly matched down to the last detail. This facilitates mounting while adhering to required norms

W2C 4 DT-PE

Weidmüller Interface GmbH & Co. KG
 Klingenbergstraße 26
 D-32758 Detmold
 Germany

www.weidmueller.com

Accessories

General ordering data

Type	FSC-HPG BK W2C 4	Version	
Order No.	2939280000	Accessories holder (terminal), Wemid, black	
GTIN (EAN)	4099986702295		
Qty.	20 ST		

Disconnect plugs



In contrast to the terminal blocks with integrated disconnect lever, our disconnect plugs can be completely detached or removed from the terminal block and the respective application and offer a flexible alternative solution to our standard disconnectors.

General ordering data

Type	DTLE 2.5/4	Version	
Order No.	2910530000	Locking element (terminal), Wemid, red	
GTIN (EAN)	4099986519466		
Qty.	25 ST		

MultiFit



MultiMark MultiFit

For connectors from competitors.

The elastic surface finish makes for simple installation.

This special material enables the strips to be stretched to accommodate slight variations in spacing, especially with long terminal blocks.

A print resolution of 300 dpi also produces a very legible script. Your benefits with MultiMark

- Firm hold and durable printing
- Continuous strips save installation time
- Easy mounting thanks to an innovative composite material
- Large label field for optimal legibility
- High flexibility thanks to manufacturer independence

General ordering data

Type	EL KSM 10.6 MM WS 30M	Version	
Order No.	2799270000	Terminal marker, 10.6 x 5 mm, white	
GTIN (EAN)	4064675261032		
Qty.	1 ST		