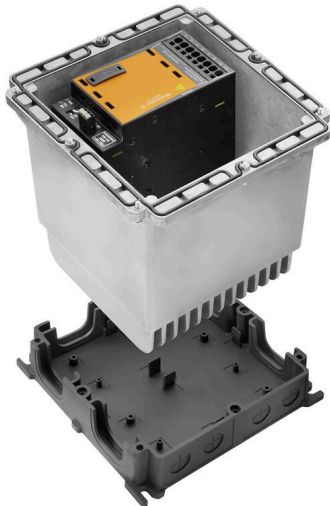

FP PRO TOP3 48/10 2M**Weidmüller Interface GmbH & Co. KG**

Klingenbergstraße 26

D-32758 Detmold

Germany

www.weidmueller.com

PROtop power supplies offer a wide range of functions with many advantages.

These include high energy efficiency, outstanding power reserves, high reliability and optional communication capability. PROtop also supports direct parallel connection with load balancing. With the possibility of integrating our PROtop power supplies into the FieldPower® system, the entire range of functions becomes available in the field – with all the advantages of the FieldPower® modular system.

General ordering data

Version	FieldPower® power supply unit, IP65, in complete state, 10A, 48 V, DC, PUSH IN
Order No.	2887620000
Type	FP PRO TOP3 48/10 2M
GTIN (EAN)	4064675859871
Qty.	1 items

FP PRO TOP3 48/10 2M

Weidmüller Interface GmbH & Co. KG

Klingenbergstraße 26

D-32758 Detmold

Germany

www.weidmueller.com

Technical data

Approvals

ROHS	Conform
------	---------

Dimensions and weights

Depth	220 mm	Depth (inches)	8.6614 inch
Height	196 mm	Height (inches)	7.7165 inch
Width	196 mm	Width (inches)	7.7165 inch
Net weight	4150 g		

Temperatures

Storage temperature	-40 °C...85 °C	Operating temperature	-25 °C...45 °C
Operating temperature range	-25...50 °C	Start-up	≥ -40 °C
Humidity	35...85%, non condensing and non freezing		

Environmental Product Compliance

RoHS Compliance Status	Compliant with exemption
RoHS Exemption (if applicable/known)	6c
REACH SVHC	Lead 7439-92-1, Potassium perfluorobutane sulfonate 29420-49-3
SCIP	7645f3b1-6db9-495d-9e21-ab1d894aff05

Input

AC input voltage range	3 x 320...3 x 575 V AC / 2 x 360...2 x 575 V AC	Recommended back-up fuse	3 - 5 A, Char C
Frequency range AC	45...65 Hz	Type of connection	PUSH IN
Wire connection method	PUSH IN	Surge protection	Varistor
Input fuse (internal)	No	AC current consumption	1,5 A @ 400 V DC / 2 A @ 320 V AC
DC input voltage range	450...800 V DC (max. 500 V DC acc. to UL508)	Inrush current	Max. 10 A

Output

Output power	480 W	Rated output voltage	48 V DC ± 1 %
Output voltage, max.	56 V	Output voltage, min.	45 V
Wire connection method	PUSH IN	Surge protection	Varistor
Output voltage type	DC	Output voltage, note	(adjustable via potentiometer)
Nominal output current for Unom	10 A @ 60 °C	Switch-on delay	1 s
Output current	10A	Adjustable rated current	No
Output voltage	48 V	Triggering characteristic	see characteristic curve

General data

Installation advice	Lid screws included	Humidity	35...85%, non condensing and non freezing
Protection degree	IP65, in complete state	Surge voltage category	III, II
Short-circuit protection	Yes, internal		

Insulation coordination

Surge voltage category	III, II
------------------------	---------

FP PRO TOP3 48/10 2M

Weidmüller Interface GmbH & Co. KG
 Klingenbergstraße 26
 D-32758 Detmold
 Germany

www.weidmueller.com

Technical data

Input

AC input voltage range	3 x 320...3 x 575 V AC / 2 x 360...2 x 575 V AC	Recommended back-up fuse	3 - 5 A, Char C
Frequency range AC	45...65 Hz	Surge protection	Varistor
AC current consumption	1,5 A @ 400 V DC / 2 A @ 320 V AC	DC input voltage range	450...800 V DC (max. 500 V DC acc. to UL508)
Inrush current	Max. 10 A	Input fuse (internal)	No

Output

Output power	480 W	Output voltage, max.	56 V
Output voltage, min.	45 V	Output voltage type	DC
Output voltage, note	(adjustable via potentiometer)	Switch-on delay	1 s
Output current	10A	Adjustable rated current	No
Output voltage	48 V	Triggering characteristic	see characteristic curve
Rated output voltage	48 V DC ± 1 %	Nominal output current for Unom	10 A @ 60 °C

Classifications

ETIM 8.0	EC002540	ETIM 9.0	EC002540
ETIM 10.0	EC002540	ECLASS 14.0	27-04-07-01
ECLASS 15.0	27-04-07-01		

FP PRO TOP3 48/10 2M

Weidmüller Interface GmbH & Co. KG
 Klingenbergstraße 26
 D-32758 Detmold
 Germany

Drawings

www.weidmueller.com

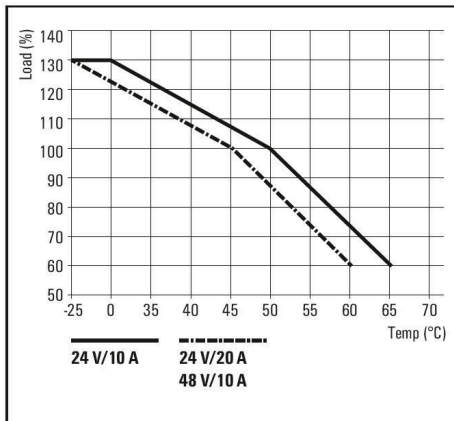
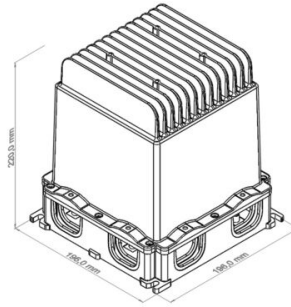
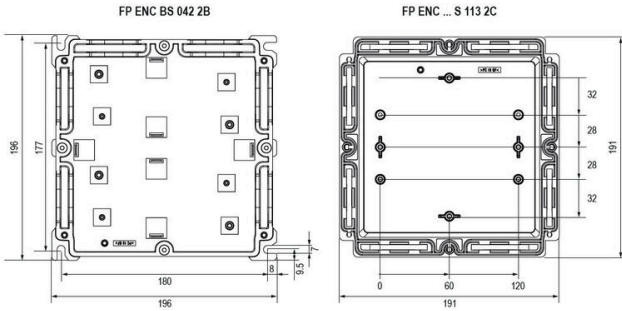

FP PRO TOP3 48/10 2M

Weidmüller Interface GmbH & Co. KG
 Klingenbergstraße 26
 D-32758 Detmold
 Germany

www.weidmueller.com

Accessories

Seals

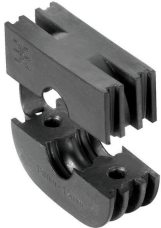

Intelligent cabling solutions can save you valuable time and money.

The FieldPower® modular system contains the right solution for every cabling task.

Foldable seals for the use of pre-assembled cables
 Seals available with M16 and M20 connection thread
 Integration of operating and signalling devices into the seal possible

General ordering data

Type	DG D0 PT6	Version
Order No.	4323240000	Field Power® sealing insert, Blank seal, IP65, with corresponding
GTIN (EAN)	4032248641246	enclosure, EPDM
Qty.	10 ST	
Type	DG M16 PT6	Version
Order No.	2545540000	Field Power® sealing insert, Seal with connection thread, IP65, with
GTIN (EAN)	4050118555523	corresponding enclosure, EPDM
Qty.	1 ST	
Type	DG M20 PT6	Version
Order No.	2545550000	Field Power® sealing insert, Seal with connection thread, IP65, with
GTIN (EAN)	4050118555530	corresponding enclosure, EPDM
Qty.	1 ST	
Type	RKDG 2XD8.5 WG PT6	Version
Order No.	1114530000	Field Power® sealing insert, Seal, IP54, with corresponding
GTIN (EAN)	4032248892624	enclosure, EPDM
Qty.	10 ST	
Type	RKDG D11 PT6	Version
Order No.	4323210000	Field Power® sealing insert, Foldable seal, IP65 with corresponding
GTIN (EAN)	4032248641215	housing, IP65, with corresponding enclosure, EPDM
Qty.	10 ST	
Type	RKDG D13 PT6	Version
Order No.	4323230000	Field Power® sealing insert, Foldable seal, IP65 with corresponding
GTIN (EAN)	4032248641239	housing, IP65, with corresponding enclosure, EPDM
Qty.	10 ST	
Type	RKDG D15 PT6	Version
Order No.	4323220000	Field Power® sealing insert, Foldable seal, IP65 with corresponding
GTIN (EAN)	4032248641222	housing, IP65, with corresponding enclosure, EPDM
Qty.	10 ST	
Type	RKDG D17 PT6	Version
Order No.	4324010000	Field Power® sealing insert, Foldable seal, IP65 with corresponding
GTIN (EAN)	4032248641284	housing, IP65, with corresponding enclosure, EPDM
Qty.	10 ST	
Type	RKDG D18 WG PT6	Version
Order No.	2491870000	Field Power® sealing insert, Seal, IP54, with corresponding
GTIN (EAN)	4050118501537	enclosure, EPDM
Qty.	10 ST	
Type	RKDG D24 WG PT6	Version
Order No.	1069060000	Field Power® sealing insert, Seal, IP54, with corresponding
GTIN (EAN)	4032248827053	enclosure, EPDM
Qty.	10 ST	

FP PRO TOP3 48/10 2M

Weidmüller Interface GmbH & Co. KG
 Klingenbergstraße 26
 D-32758 Detmold
 Germany

www.weidmueller.com

Accessories

Type	RKDG D9 PT6	Version
Order No.	4329610000	Field Power® sealing insert, Foldable seal, IP65 with corresponding
GTIN (EAN)	4032248668687	housing, IP65, with corresponding enclosure, EPDM
Qty.	10 ST	

Fuse plug



Power distribution using uncut cables with cross-sections from 1.5 to 6 mm².

Power supply / T-branch tap via PUSH IN connection (0.5 to 10 mm²) and/or plug-in connection (0.5 to 4 mm²). Coloured markings provide clear assignment of wires.

- Power supply
- Power distribution
- Power branching

General ordering data

Type	PTSI 4/LD 36V AC/DC	Version
Order No.	1252210000	Field Power® plug-in connector, Fuse, IP20, Polyamide, PUSH
GTIN (EAN)	4050118044331	IN, Number of poles : 5
Qty.	1 ST	
Type	PTSI 4/LD 400V AC	Version
Order No.	1961770000	Field Power® plug-in connector, Fuse, IP20, Polyamide, PUSH
GTIN (EAN)	4032248641765	IN, Number of poles : 5
Qty.	1 ST	

AC

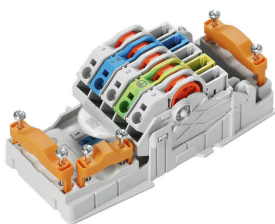

Power distribution using uncut cables with cross-sections from 1.5 to 6 mm².

Power supply / T-branch tap via PUSH IN connection (0.5 to 10 mm²) and/or plug-in connection (0.5 to 4 mm²). Coloured markings provide clear assignment of wires.

- Power supply
- Power distribution
- Power branching

General ordering data

Type	PT6	Version
Order No.	1957620000	FieldPower® contact element, AC, IP20, Insulation displacement
GTIN (EAN)	4032248642489	connection (IDC), PUSH IN, Number of poles : 5
Qty.	1 ST	

FP PRO TOP3 48/10 2M

Weidmüller Interface GmbH & Co. KG
 Klingenbergstraße 26
 D-32758 Detmold
 Germany

www.weidmueller.com

Accessories

DC



Power distribution using uncut cables with cross-sections from 1.5 to 6 mm².

Power supply / T-branch tap via PUSH IN connection (0.5 to 10 mm²) and/or plug-in connection (0.5 to 4 mm²). Coloured markings provide clear assignment of wires.

- Power supply
- Power distribution
- Power branching

General ordering data

Type	PT6 DC	Version	
Order No.	1126840000	FieldPower® contact element, DC, IP20, Insulation displacement connection (IDC), PUSH IN, Number of poles : 5	
GTIN (EAN)	4032248908462		
Qty.	1 ST		

Plug-in connector



Power distribution using uncut cables with cross-sections from 1.5 to 6 mm².

Power supply / T-branch tap via PUSH IN connection (0.5 to 10 mm²) and/or plug-in connection (0.5 to 4 mm²). Coloured markings provide clear assignment of wires.

- Power supply
- Power distribution
- Power branching

General ordering data

Type	PTDS 4	Version	
Order No.	1952130000	Field Power® plug-in connector, 3-phase AC, IP20, Polyamide, PUSH IN, Number of poles : 2 x 5	
GTIN (EAN)	4032248632084		
Qty.	10 ST		
Type	PTDS 4 DC	Version	
Order No.	1009990000	Field Power® plug-in connector, DC, IP20, Polyamide, PUSH IN, Number of poles : 2 x 5	
GTIN (EAN)	4032248715244		
Qty.	10 ST		
Type	PTS 4	Version	
Order No.	1952120000	Field Power® plug-in connector, 3-phase AC, IP20, Polyamide, PUSH IN, Number of poles : 5	
GTIN (EAN)	4032248632909		
Qty.	10 ST		
Type	PTS 4 DC	Version	
Order No.	1131730000	Field Power® plug-in connector, DC, IP20, Polyamide, PUSH IN, Number of poles : 5	
GTIN (EAN)	4032248912117		
Qty.	10 ST		

FP PRO TOP3 48/10 2M

Weidmüller Interface GmbH & Co. KG
 Klingenbergstraße 26
 D-32758 Detmold
 Germany

www.weidmueller.com

Accessories

Terminal rails for lower parts of enclosure



Extensive range of accessories for the FieldPower® boxes.
 Cable seals, terminal rails, locking elements and much more.

General ordering data

Type	TS 35 PT6	Version	
Order No.	1170690000	Field Power® terminal rail, Steel, galvanized, 54 mm, for base part	
GTIN (EAN)	4032248962532		
Qty.	10 ST		

Type	FP ENC DR07 142 XB	Version	
Order No.	2633450000	Field Power® terminal rail, Steel, galvanized, 142 mm, for base part	
GTIN (EAN)	4050118664416		
Qty.	5 ST		

Terminal rails for aluminum cover



Extensive range of accessories for the FieldPower® boxes.
 Cable seals, terminal rails, locking elements and much more.

General ordering data

Type	FP ENC DR15 68 XC A	Version	
Order No.	8000046634	Field Power® terminal rail, Steel, galvanized, 68 mm, for aluminium lid	
GTIN (EAN)	4050118686586		
Qty.	5 ST		

Type	FP ENC DR07 080 XC A	Version	
Order No.	2633730000	Field Power® terminal rail, Steel, galvanized, 80 mm, for aluminium lid	
GTIN (EAN)	4050118664379		
Qty.	5 ST		

FP PRO TOP3 48/10 2M

Weidmüller Interface GmbH & Co. KG
 Klingenbergstraße 26
 D-32758 Detmold
 Germany

www.weidmueller.com

Accessories

Plastic lock nuts, grey



In addition to cable glands for a wide range of applications, the product portfolio is rounded off by plugs, pressure compensation elements, adaptors and the corresponding accessories such as locknuts, sealing rings, flat washers and earthing rings.

General ordering data

Type	SKMU M20 - K GR	Version	
Order No.	1772460000	SKMU PA (plastic locknut), Locknut, M 20, 6 mm, Polyamid 6 (PA6 -	
GTIN (EAN)	4032248130207	GF30)	
Qty.	100 ST		

IP68 version



In addition to the extensive range of enclosures, Weidmüller offers a variety of cable glands for a wide range of applications. The cable glands made of brass, plastic and stainless steel meet the most various IP protection classes to suit any industrial enclosure. Depending on the series of cable glands and the application, the cable glands are approved and tested according to VDE, UL, UR, cULus, DNV GL or EN 45545.

General ordering data

Type	VG M20-1/K68	Version	
Order No.	1772300000	VG K (standard plastic cable gland), Cable glands, straight, M 20, 10	
GTIN (EAN)	4032248129966	mm, OD min. 6 - OD max. 12 mm, IP54, IP66, IP67, IP68 - 5 bar (30	
Qty.	50 ST	min.), Polyamide 6	
Type	VG M20 - K 68	Version	
Order No.	2811470000	VG K (standard plastic cable gland), Cable glands, straight, M 20, 10	
GTIN (EAN)	4064675292227	mm, OD min. 10 - OD max. 14 mm, IP54, IP66, IP67, IP68 - 5 bar (30	
Qty.	50 ST	min.), Polyamide 6	

DMS PRO



Weidmüller torque screwdrivers have an ergonomic design and are therefore ideal for use with one hand. They can be used without causing fatigue in all installation positions. Apart from that, they incorporate an automatic torque limiter and have a good reproducibility accuracy.

FP PRO TOP3 48/10 2M

Weidmüller Interface GmbH & Co. KG
 Klingenbergstraße 26
 D-32758 Detmold
 Germany

www.weidmueller.com

Accessories

General ordering data

Type	DMS PRO	Version	
Order No.	1479120000	Mounting tool	
GTIN (EAN)	4050118287011		
Qty.	1 ST		

Bits E6,3 - Torx®



The Weidmüller bits are standard bits which are highly popular with users thanks to their good quality, large range and efficiency. The computer-controlled hardening method enables Weidmüller to guarantee a consistently high standard of quality.

The high-quality raw materials used make it possible to reach torques far higher than any of those specified in the relevant DIN standards:

- DIN 5261 for PH/PZ bits,
- DIN 5263 for slotted bits,
- Camcar standard for TORX bits

That means a long life at high torques and hence ideal conditions for standard situations.

The benefits:

- Suitable for all types of screws. Because of their excellent hardness values of 59-61 HRC, they are suitable for use with both manual and power tools.
- Good wearing resistance and thus a long life expectancy.
- Optimum fit in all DIN screws means low wear and optimum torque transmission.
- Manufactured to meet professional quality criteria according to relevant ISO standards with a consistently high standard of quality.

General ordering data

Type	BIT E6,3 T20 X 150	Version	
Order No.	2821510000	Mounting tool	
GTIN (EAN)	4064675359050		
Qty.	5 ST		

Adapters

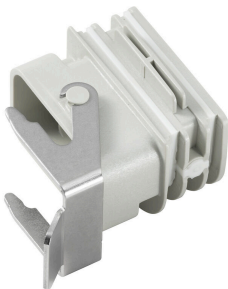

HQ adapter for FieldPower®

Tool-free installation like a FieldPower cable seal
 Suitable for the HQ 4/2, HQ 8 and HQ 17 plug-in connector inserts

Optionally with lockable protective cover (protection against being switched on again, in accordance with EN 60204-1)

FP PRO TOP3 48/10 2M

Weidmüller Interface GmbH & Co. KG
Klingenbergstraße 26
D-32758 Detmold
Germany

www.weidmueller.com

Accessories

General ordering data

Type	BG ARGH HQP ALU PT6	Version	
Order No.	1532200000	Adapter, Field Power® sealing insert, HQ adapter, IP65, with	
GTIN (EAN)	4050118337433	corresponding enclosure, Polycarbonate, glass fibre reinforced,	
Qty.	1 ST	lockable: No	
Type	BG ARGH HQP ALU PT6 CS	Version	
Order No.	1532210000	Adapter, Field Power® sealing insert, HQ adapter, IP65, with	
GTIN (EAN)	4050118337600	corresponding enclosure, Polycarbonate, glass fibre reinforced,	
Qty.	1 ST	lockable: Yes	