

S2C 4 DL BL**Weidmüller Interface GmbH & Co. KG**Klingenbergstraße 26
D-32758 Detmold
Germany

www.weidmueller.com

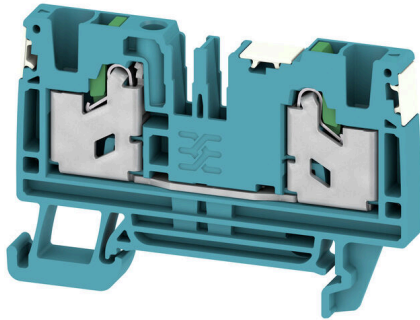

To feed through power, signal, and data is the classical requirement in electrical engineering and panel building. The insulating material, the connection system and the design of the terminal blocks are the differentiating features. A feed-through terminal block is suitable for joining and/or connecting one or more conductors. They could have one or more connection levels that are on the same potential or insulated against one another.

General ordering data

| | |
|------------|--|
| Version | Feed-through terminal block, SNAP IN, blue, 4 mm ² , 32 A, 1000 V, Number of connections: 2 |
| Order No. | 2874940000 |
| Type | S2C 4 DL BL |
| GTIN (EAN) | 4064675649984 |
| Qty. | 50 items |

S2C 4 DL BL

Weidmüller Interface GmbH & Co. KG
 Klingenbergstraße 26
 D-32758 Detmold
 Germany

www.weidmueller.com

Technical data

Approvals

Approvals



| | |
|---------------------------|----------------------------|
| ROHS | Conform |
| UL File Number Search | UL Website |
| Certificate No. (cURus) | E60693 |
| Certificate No. (cURusEX) | E184763 |

Dimensions and weights

| | | | |
|------------|---------|-----------------|-------------|
| Depth | 41.5 mm | Depth (inches) | 1.6339 inch |
| Height | 62 mm | Height (inches) | 2.4409 inch |
| Width | 6.1 mm | Width (inches) | 0.2402 inch |
| Net weight | 13.67 g | | |

Temperatures

| | | | |
|----------------------------------|----------------|----------------------------------|--------|
| Storage temperature | -25 °C...55 °C | Continuous operating temp., min. | -60 °C |
| Continuous operating temp., max. | 130 °C | | |

Environmental Product Compliance

| | |
|------------------------|-----------------------------|
| RoHS Compliance Status | Compliant without exemption |
| REACH SVHC | No SVHC above 0.1 wt% |

Material data

| | | | |
|--------------------------------|-------|---------------------------|------|
| Basic material | Wemid | Colour | blue |
| Colour of operational elements | green | UL 94 flammability rating | V-0 |

Rating data IECEx/ATEX

| | | | |
|--------------------------------|-------------------|---------------------------------|-------------------|
| Certificate No. (ATEX) | TUEV22ATEX8925U | Certificate No. (IECEX) | IECEXTUR22.0073U |
| Max. voltage (ATEX) | 550 V | Current (ATEX) | 29 A |
| Wire cross section max. (ATEX) | 6 mm ² | Max. voltage (IECEX) | 550 V |
| Current (IECEX) | 29 A | Wire cross section max. (IECEX) | 6 mm ² |

System specifications

| | | | |
|-------------------------------|-----|-------------------------------------|-------|
| End cover plate required | Yes | Number of potentials | 1 |
| Number of levels | 1 | Number of clamping points per level | 2 |
| Number of potentials per tier | 1 | Mounting rail | TS 35 |
| PE function | No | PEN function | No |

Additional technical data

| | | | |
|------------------|---------|--------------------------|-----|
| Open sides | right | Snap-on | Yes |
| Type of fixing | Snap-on | Explosion-tested version | Yes |
| Type of mounting | TS 35 | | |

S2C 4 DL BL

Weidmüller Interface GmbH & Co. KG

Klingenbergstraße 26
D-32758 Detmold
Germany

www.weidmueller.com

Technical data

CSA rating data

| | | | |
|-------------------------------|--------|-----------------------|-----------------|
| Wire cross section max. (CSA) | 10 AWG | Voltage size C (CSA) | 600 V |
| Current size C (CSA) | 30 A | Certificate No. (CSA) | 227442-80219640 |
| Voltage size B (CSA) | 600 V | Current size B (CSA) | 30 A |
| Voltage size D (CSA) | 600 V | Current size D (CSA) | 5 A |
| Wire cross section min. (CSA) | 20 AWG | | |

Conductors for clamping (additional connection)

Connection type, additional connection SNAP IN

Conductors for clamping (rated connection)

| | | |
|---|----------------------|---------------------|
| Gauge to IEC 60947-1 | A4 | |
| Wire connection cross section AWG, max. | AWG 12 | |
| Connection direction | top | |
| Stripping length | 12 mm | |
| Type of connection | SNAP IN | |
| Number of connections | 2 | |
| Clamping range, max. | 6 mm ² | |
| Clamping range, min. | 0.75 mm ² | |
| Blade size | 0.6 x 3.5 mm | |
| Wire connection cross section AWG, min. | AWG 20 | |
| Wire connection cross-section, finely stranded with wire-end ferrules DIN 46228/4, max. | 4 mm ² | |
| Wire connection cross-section, finely stranded with wire-end ferrules DIN 46228/4, min. | 0.75 mm ² | |
| Wire connection cross-section, finely stranded with wire-end ferrules DIN 46228/1, max. | 4 mm ² | |
| Wire connection cross-section, finely stranded with wire-end ferrules DIN 46228/1, min. | 0.75 mm ² | |
| Wire connection cross section, finely stranded, max. | 6 mm ² | |
| Wire connection cross section, finely stranded, min. | 0.75 mm ² | |
| Connection cross-section, stranded, max. | 4 mm ² | |
| Connection cross-section, stranded, min. | 0.75 mm ² | |
| Twin wire-end ferrules, max. | 1.5 mm ² | |
| Twin wire-end ferrules, min. | 0.5 mm ² | |
| Wire connection cross-section, solid core, max. | 6 mm ² | |
| Wire connection cross-section, solid core, min. | 0.75 mm ² | |
| Connection cross-section, finely stranded, min. | 0.75 mm ² | |
| Tube length for wire-end ferrule with plastic collar acc. to cross-section | Cross-section, min. | 0.5 mm ² |
| | Cross-section, max. | 1 mm ² |
| | Tube length, min. | 8 mm |
| | Tube length, max. | 12 mm |
| | Cross-section, min. | 1.5 mm ² |
| | Cross-section, max. | 2.5 mm ² |
| | Tube length, min. | 10 mm |

S2C 4 DL BL

Weidmüller Interface GmbH & Co. KG

Klingenbergstraße 26
D-32758 Detmold
Germany

www.weidmueller.com

Technical data

| | | |
|---|---------------------|----------------------|
| | Tube length, max. | 18 mm |
| | Cross-section, min. | 4 mm ² |
| | Cross-section, max. | 4 mm ² |
| | Tube length, min. | 12 mm |
| | Tube length, max. | 18 mm |
| Tube length for wire-end ferrule without plastic collar acc. to cross-section | Cross-section, min. | 0.5 mm ² |
| | Cross-section, max. | 1 mm ² |
| | Tube length, min. | 10 mm |
| | Tube length, max. | 10 mm |
| | Cross-section, min. | 1.5 mm ² |
| | Cross-section, max. | 2.5 mm ² |
| | Tube length, min. | 10 mm |
| | Tube length, max. | 18 mm |
| | Cross-section, min. | 4 mm ² |
| | Cross-section, max. | 4 mm ² |
| | Tube length, min. | 12 mm |
| | Tube length, max. | 18 mm |
| Tube length for twin wire-end ferrule acc. to cross-section | Cross-section, min. | 0.5 mm ² |
| | Cross-section, max. | 0.5 mm ² |
| | Tube length, min. | 10 mm |
| | Tube length, max. | 12 mm |
| | Cross-section, min. | 0.75 mm ² |
| | Cross-section, max. | 0.75 mm ² |
| | Tube length, min. | 10 mm |
| | Tube length, max. | 18 mm |
| | Cross-section, min. | 1 mm ² |
| | Cross-section, max. | 1 mm ² |
| | Tube length, min. | 12 mm |
| | Tube length, max. | 18 mm |
| | Cross-section, min. | 1.5 mm ² |
| | Cross-section, max. | 2.5 mm ² |
| | Tube length, min. | 18 mm |
| | Tube length, max. | 18 mm |

General

| | | | |
|---|---------------|---|--------|
| Wire connection cross section AWG, max. | AWG 12 | Wire connection cross section AWG, min. | AWG 20 |
| Standards | IEC 60947-7-1 | Mounting rail | TS 35 |

Rating data

| | | | |
|--|-------------------|---------------------------------|---------------|
| Rated cross-section | 4 mm ² | Rated voltage | 1000 V |
| Rated DC voltage | 1000 V | Nominal current | 32 A |
| Current at maximum wires | 32 A | Standards | IEC 60947-7-1 |
| Volume resistance according to IEC 60947-7-x | 1 mΩ | Rated impulse withstand voltage | 8 kV |
| Power loss in accordance with IEC 60947-7-x | 1.02 W | Surge voltage category | III |
| Pollution severity | 3 | | |

UL rating data

| | | | |
|--|--------|--|--------|
| Conductor size Factory wiring max. (cURus) | 10 AWG | Voltage size B (cURus) | 600 V |
| Voltage size D (cURus) | 600 V | Certificate No. (cURus) | E60693 |
| Conductor size Field wiring min. (cURus) | 20 AWG | Conductor size Factory wiring min. (cURus) | 20 AWG |
| Current size B (cURus) | 30 A | Voltage size C (cURus) | 600 V |

S2C 4 DL BL

Weidmüller Interface GmbH & Co. KG
Klingenbergstraße 26
D-32758 Detmold
Germany

www.weidmueller.com

Technical data

| | | | |
|---|------|------------------------|-----|
| Current size C (cURus) | 30 A | Current size D (cURus) | 5 A |
| Conductor size Field wiring max. (cURus) 10 AWG | | | |

Classifications

| | | | |
|-------------|-------------|-------------|-------------|
| ETIM 8.0 | EC000897 | ETIM 9.0 | EC000897 |
| ETIM 10.0 | EC000897 | ECLASS 14.0 | 27-25-01-01 |
| ECLASS 15.0 | 27-25-01-01 | | |

Drawings

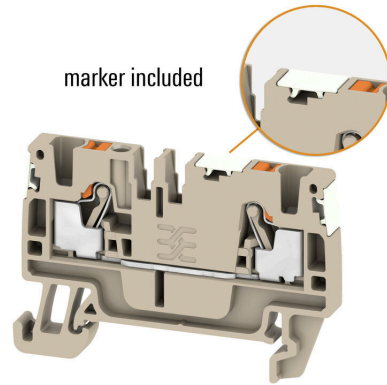
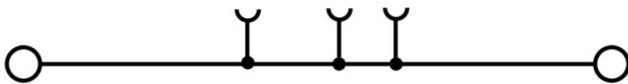

S2C 4 DL BL

Weidmüller Interface GmbH & Co. KG
 Klingenbergstraße 26
 D-32758 Detmold
 Germany

www.weidmueller.com

Accessories

End bracket

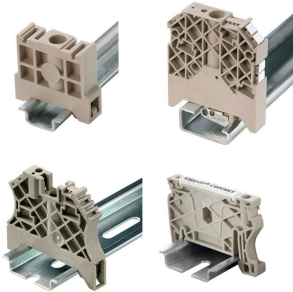

Weidmüller's range of products includes end brackets that guarantee a permanent, reliable mounting on the terminal rail and prevent sliding. Versions with and without screws are available. The end brackets include marking options, also for group markers, and also a test plug holder.

General ordering data

| | | | |
|------------|----------------------------|---------|-----------------------|
| Type | AEB 35 SC/1 | Version | |
| Order No. | 1991920000 | Version | A-series, End bracket |
| GTIN (EAN) | 4050118376722 | | |
| Qty. | 50 ST | | |

Testadapter and testsockets



Test adapters and test plugs are used for the electrical connection between terminal blocks and the test equipment. In this way, an electrical contact can be established in the wired state and measurements can be done easily.

General ordering data

| | | | |
|------------|----------------------------|---------|---|
| Type | ATPG 4 MI-R | Version | |
| Order No. | 1991860000 | Version | Test adapter (terminal), 1.5 mm ² , 250 V, 0.2 A |
| GTIN (EAN) | 4050118376661 | | |
| Qty. | 50 ST | | |
| Type | ATPG 1.5-10 L | Version | |
| Order No. | 1991890000 | Version | Test adapter (terminal), 1.5 mm ² , 250 V, 0.2 A |
| GTIN (EAN) | 4050118376647 | | |
| Qty. | 50 ST | | |

Cross-connections

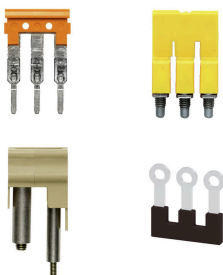

The distribution or multiplication of a potential to adjoining terminal blocks is realized via a cross-connection. Additional wiring effort can be easily avoided. Even if the poles are broken out, contact reliability in the terminal blocks is still ensured. Our portfolio offers pluggable and screwable cross-connection systems for modular terminal blocks.

S2C 4 DL BL

Weidmüller Interface GmbH & Co. KG

Klingenbergstraße 26
D-32758 Detmold
Germany

www.weidmueller.com

Accessories

General ordering data

| | | |
|------------|----------------------------|---|
| Type | ZQV 4N/10 | Version |
| Order No. | 1528090000 | Cross-connector (terminal), Plugged, orange, 32 A, Number of poles: |
| GTIN (EAN) | 4050118332896 | 10, Pitch in mm (P): 6.10, Insulated: Yes, Width: 58.7 mm |
| Qty. | 20 ST | |
| Type | ZQV 4N/10 BL | Version |
| Order No. | 1528230000 | Cross-connector (terminal), Plugged, blue, 32 A, Number of poles: 10, |
| GTIN (EAN) | 4050118333138 | Pitch in mm (P): 6.10, Insulated: Yes, Width: 58.7 mm |
| Qty. | 20 ST | |
| Type | ZQV 4N/2 | Version |
| Order No. | 1527930000 | Cross-connector (terminal), Plugged, orange, 32 A, Number of poles: |
| GTIN (EAN) | 4050118332766 | 2, Pitch in mm (P): 6.10, Insulated: Yes, Width: 9.9 mm |
| Qty. | 60 ST | |
| Type | ZQV 4N/2 BL | Version |
| Order No. | 1528040000 | Cross-connector (terminal), Plugged, blue, 32 A, Number of poles: 2, |
| GTIN (EAN) | 4050118332773 | Pitch in mm (P): 6.10, Insulated: Yes, Width: 9.9 mm |
| Qty. | 60 ST | |
| Type | ZQV 4N/3 | Version |
| Order No. | 1527940000 | Cross-connector (terminal), Plugged, orange, 32 A, Number of poles: |
| GTIN (EAN) | 4050118332865 | 3, Pitch in mm (P): 6.10, Insulated: Yes, Width: 16 mm |
| Qty. | 60 ST | |
| Type | ZQV 4N/3 BL | Version |
| Order No. | 1528080000 | Cross-connector (terminal), Plugged, blue, 32 A, Number of poles: 3, |
| GTIN (EAN) | 4050118333008 | Pitch in mm (P): 6.10, Insulated: Yes, Width: 16 mm |
| Qty. | 60 ST | |
| Type | ZQV 4N/4 | Version |
| Order No. | 1527970000 | Cross-connector (terminal), Plugged, orange, 32 A, Number of poles: |
| GTIN (EAN) | 4050118332889 | 4, Pitch in mm (P): 6.10, Insulated: Yes, Width: 22.1 mm |
| Qty. | 60 ST | |
| Type | ZQV 4N/4 BL | Version |
| Order No. | 1528120000 | Cross-connector (terminal), Plugged, blue, 32 A, Number of poles: 4, |
| GTIN (EAN) | 4050118332872 | Pitch in mm (P): 6.10, Insulated: Yes, Width: 22.1 mm |
| Qty. | 60 ST | |
| Type | ZQV 4N/5 | Version |
| Order No. | 1527980000 | Cross-connector (terminal), Plugged, orange, 32 A, Number of poles: |
| GTIN (EAN) | 4050118332759 | 5, Pitch in mm (P): 6.10, Insulated: Yes, Width: 28.2 mm |
| Qty. | 60 ST | |
| Type | ZQV 4N/5 BL | Version |
| Order No. | 1528140000 | Cross-connector (terminal), Plugged, blue, 32 A, Number of poles: 5, |
| GTIN (EAN) | 4050118333015 | Pitch in mm (P): 6.10, Insulated: Yes, Width: 28.2 mm |
| Qty. | 60 ST | |
| Type | ZQV 4N/50 | Version |
| Order No. | 1528130000 | Cross-connector (terminal), Plugged, orange, 32 A, Number of poles: |
| GTIN (EAN) | 4050118332902 | 50, Pitch in mm (P): 6.10, Insulated: Yes, Width: 303.7 mm |
| Qty. | 5 ST | |
| Type | ZQV 4N/50 BL | Version |
| Order No. | 1528240000 | Cross-connector (terminal), Plugged, blue, 32 A, Number of poles: 50, |
| GTIN (EAN) | 4050118333121 | Pitch in mm (P): 6.10, Insulated: Yes, Width: 303.7 mm |
| Qty. | 5 ST | |
| Type | ZQV 4N/6 | Version |
| Order No. | 1527990000 | Cross-connector (terminal), Plugged, orange, 32 A, Number of poles: |
| GTIN (EAN) | 4050118332919 | 6, Pitch in mm (P): 6.10, Insulated: Yes, Width: 34.3 mm |
| Qty. | 20 ST | |

S2C 4 DL BL

Weidmüller Interface GmbH & Co. KG
 Klingenbergstraße 26
 D-32758 Detmold
 Germany

www.weidmueller.com

Accessories

| | | |
|------------|----------------------------|--|
| Type | ZQV 4N/6 BL | Version |
| Order No. | 1528170000 | Cross-connector (terminal), Plugged, blue, 32 A, Number of poles: 6, |
| GTIN (EAN) | 4050118332926 | Pitch in mm (P): 6.10, Insulated: Yes, Width: 34.3 mm |
| Qty. | 20 ST | |
| Type | ZQV 4N/7 | Version |
| Order No. | 1528020000 | Cross-connector (terminal), Plugged, orange, 32 A, Number of poles: |
| GTIN (EAN) | 4050118332780 | 7, Pitch in mm (P): 6.10, Insulated: Yes, Width: 40.4 mm |
| Qty. | 20 ST | |
| Type | ZQV 4N/7 BL | Version |
| Order No. | 1528180000 | Cross-connector (terminal), Plugged, blue, 32 A, Number of poles: 7, |
| GTIN (EAN) | 4050118333114 | Pitch in mm (P): 6.10, Insulated: Yes, Width: 40.4 mm |
| Qty. | 20 ST | |
| Type | ZQV 4N/8 | Version |
| Order No. | 1528030000 | Cross-connector (terminal), Plugged, orange, 32 A, Number of poles: |
| GTIN (EAN) | 4050118332841 | 8, Pitch in mm (P): 6.10, Insulated: Yes, Width: 46.5 mm |
| Qty. | 20 ST | |
| Type | ZQV 4N/8 BL | Version |
| Order No. | 1528190000 | Cross-connector (terminal), Plugged, blue, 32 A, Number of poles: 8, |
| GTIN (EAN) | 4050118332858 | Pitch in mm (P): 6.10, Insulated: Yes, Width: 46.5 mm |
| Qty. | 20 ST | |
| Type | ZQV 4N/9 | Version |
| Order No. | 1528070000 | Cross-connector (terminal), Plugged, orange, 32 A, Number of poles: |
| GTIN (EAN) | 4050118332797 | 9, Pitch in mm (P): 6.10, Insulated: Yes, Width: 52.6 mm |
| Qty. | 20 ST | |
| Type | ZQV 4N/9 BL | Version |
| Order No. | 1528220000 | Cross-connector (terminal), Plugged, blue, 32 A, Number of poles: 9, |
| GTIN (EAN) | 4050118333107 | Pitch in mm (P): 6.10, Insulated: Yes, Width: 52.6 mm |
| Qty. | 20 ST | |

Accessories

Accessories for testing and measuring equipment



General ordering data

| | | |
|------------|----------------------------|------------|
| Type | ZUB MULTIMETER | Version |
| Order No. | 9205270000 | Multimeter |
| GTIN (EAN) | 4032248723522 | |
| Qty. | 1 ST | |

S2C 4 DL BL

Weidmüller Interface GmbH & Co. KG

Klingenbergstraße 26

D-32758 Detmold

Germany

www.weidmueller.com

Accessories

End bracket

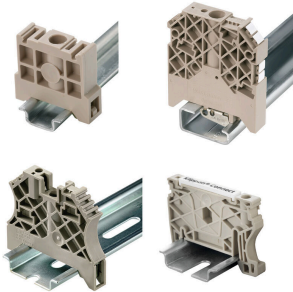

Weidmüller's range of products includes end brackets that guarantee a permanent, reliable mounting on the terminal rail and prevent sliding. Versions with and without screws are available. The end brackets include marking options, also for group markers, and also a test plug holder.

General ordering data

| | | | |
|------------|----------------------------|---------|-----------------------|
| Type | AEB 35 SC/1 BK | Version | |
| Order No. | 2475310000 | Version | A-series, End bracket |
| GTIN (EAN) | 4050118487114 | | |
| Qty. | 50 ST | | |

Marker holder

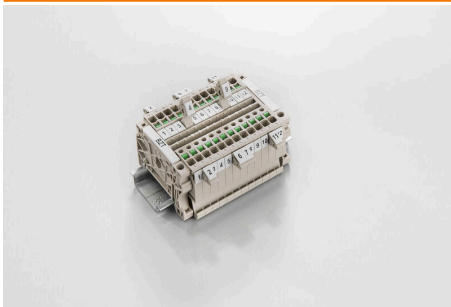

The marker holder offer the possibility of additional mounting of standard markers with a pitch of 5 or 5.1 mm. The angled holders can be optionally snapped together and could be mounted in all standard marking channels of the Klippon® Connect modular terminal blocks. Fitting marker types could be found under the respective accessories of the designation marking holder.

General ordering data

| | | | |
|------------|----------------------------|---------|----------------------------|
| Type | BZT 1 WS 10/5 | Version | |
| Order No. | 1805490000 | Version | Accessories, Marker holder |
| GTIN (EAN) | 4032248270231 | | |
| Qty. | 100 ST | | |
| Type | BZT 1 ZA WS 10/5 | Version | |
| Order No. | 1805520000 | Version | Accessories, Marker holder |
| GTIN (EAN) | 4032248270248 | | |
| Qty. | 100 ST | | |

End plates and partition plates



Partition plates and end plates are essential accessories for terminal blocks. Partition plates provide optical and electrical separation of different potentials and functional groups, increasing safety and ensuring a clear structure inside the control cabinet. End plates close the terminal block row on the sides, protect against contact with live parts, and ensure a clean, stable finish. Both components are precisely matched to the respective Weidmüller terminal block series, contributing to safe, compliant, and professional wiring.

S2C 4 DL BL

Weidmüller Interface GmbH & Co. KG
 Klingenbergstraße 26
 D-32758 Detmold
 Germany

www.weidmueller.com

Accessories

General ordering data

| | | |
|------------|----------------------------|---------------------------|
| Type | APP 2 | Version |
| Order No. | 2489090000 | A-series, Partition plate |
| GTIN (EAN) | 4050118499308 | |
| Qty. | 50 ST | |

End bracket

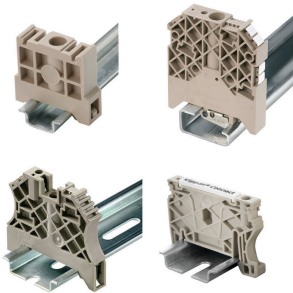

Weidmüller's range of products includes end brackets that guarantee a permanent, reliable mounting on the terminal rail and prevent sliding. Versions with and without screws are available. The end brackets include marking options, also for group markers, and also a test plug holder.

General ordering data

| | | |
|------------|----------------------------|-----------------------|
| Type | AEB 35 SCL/1 V0 | Version |
| Order No. | 2661280000 | A-series, End bracket |
| GTIN (EAN) | 4050118702163 | |
| Qty. | 20 ST | |
| Type | AEB 35 SCL/1 V0 BK | Version |
| Order No. | 2661300000 | A-series, End bracket |
| GTIN (EAN) | 4050118702187 | |
| Qty. | 20 ST | |
| Type | AEB 35 SCL/1 V0 GY | Version |
| Order No. | 2661290000 | A-series, End bracket |
| GTIN (EAN) | 4050118702170 | |
| Qty. | 20 ST | |

End plates and partition plates



Partition plates and end plates are essential accessories for terminal blocks. Partition plates provide optical and electrical separation of different potentials and functional groups, increasing safety and ensuring a clear structure inside the control cabinet. End plates close the terminal block row on the sides, protect against contact with live parts, and ensure a clean, stable finish. Both components are precisely matched to the respective Weidmüller terminal block series, contributing to safe, compliant, and professional wiring.

General ordering data

| | | |
|------------|----------------------------|---------------------|
| Type | AEP 4C 4 OR | Version |
| Order No. | 2051920000 | A-series, End plate |
| GTIN (EAN) | 4050118412000 | |
| Qty. | 20 ST | |

S2C 4 DL BL

Weidmüller Interface GmbH & Co. KG

Klingenbergstraße 26

D-32758 Detmold

Germany

www.weidmueller.com

Accessories

Slotted screwdriver

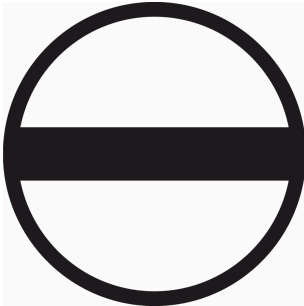

VDE insulated screwdriver sets, for working on live parts up to 1000 V AC and 1500 V DC, DIN EN 60900, IEC 900. Each piece is "GS" safety tested. Blade made from fully hardened, high-alloy chromium-vanadium-molybdenum steel, gun-metal finish.

General ordering data

| | | | |
|------------|----------------------------|---|--|
| Type | SDIS SLIM 0.6X3.5X100 | Version | |
| Order No. | 2749610000 | Mounting tool, Blade width (B): 3.5 mm, Blade length: 100 mm, Blade thickness (A): 0.6 mm | |
| GTIN (EAN) | 4050118896350 | | |
| Qty. | 1 ST | | |

End plates and partition plates



Partition plates and end plates are essential accessories for terminal blocks. Partition plates provide optical and electrical separation of different potentials and functional groups, increasing safety and ensuring a clear structure inside the control cabinet. End plates close the terminal block row on the sides, protect against contact with live parts, and ensure a clean, stable finish. Both components are precisely matched to the respective Weidmüller terminal block series, contributing to safe, compliant, and professional wiring.

General ordering data

| | | | |
|------------|----------------------------|---|--|
| Type | SEP 2C 4 | Version | |
| Order No. | 2874790000 | End plate for terminals, dark beige, Height: 60.3 mm, Width: 2 mm, V-0, Wemid, Snap-on: Yes | |
| GTIN (EAN) | 4064675649823 | | |
| Qty. | 20 ST | | |

Testadapter and testsockets



Test adapters and test plugs are used for the electrical connection between terminal blocks and the test equipment. In this way, an electrical contact can be established in the wired state and measurements can be done easily.

General ordering data

| | | | |
|------------|----------------------------|--|--|
| Type | FZS 2/4 RT/80 SAKT4 | Version | |
| Order No. | 1276300000 | Plug (terminal), Plug-in connection, 2 mm ² , Number of connections: 2, Number of poles: 1, Width: 9 mm | |
| GTIN (EAN) | 4008190026080 | | |
| Qty. | 20 ST | | |