

LMF APL 5.00/03/180 3.5SN BX

Weidmüller Interface GmbH & Co. KG
Klingenbergstraße 26
D-32758 Detmold
Germany

www.weidmueller.com

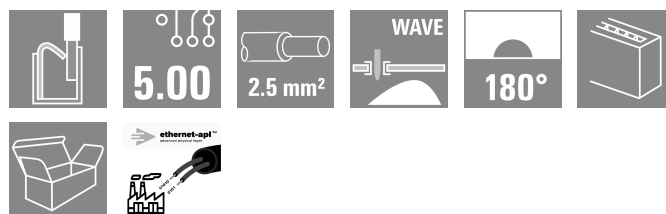
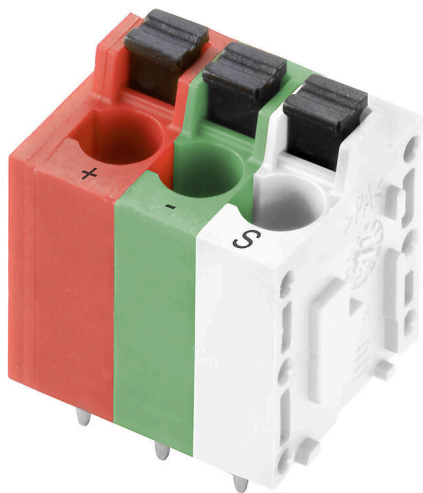

Features and benefits:

- Ethernet-APL compliant
- Space and weight saving design
- Cost-effective alternative to RJ45 and M12 connections
- Available with PUSH IN, SNAP IN, clamping yoke or tension spring connection
- Suitable for THT and THR soldering processes
- 10 Mbit/s communication for long ranges (1000m) according to IEEE 802.3cg-2019
- PoDL remote power supply according to IEEE 802.3bu
- Ethernet-APL is suitable for all IIoT devices and tailored for the process industry

General ordering data

Version	Printed circuit board terminals, 5.00 mm, Number of poles: 3, 180°, Solder pin length (l): 3.5 mm, tinned, orange, coloured, PUSH IN with push button, Clamping range, max. : 2.5 mm², Box
Order No.	2873470000
Type	LMF APL 5.00/03/180 3.5SN BX
GTIN (EAN)	4064675644507
Qty.	90 items
Product data	IEC: 400 V / 24 A / 0.5 - 2.5 mm² UL: 300 V / 20 A / AWG 24 - AWG 12
Packaging	Box

LMF APL 5.00/03/180 3.5SN BX

Weidmüller Interface GmbH & Co. KG
Klingenbergstraße 26
D-32758 Detmold
Germany

www.weidmueller.com

Technical data

Approvals

Approvals



ROHS Conform

UL File Number Search [UL Website](#)

Certificate No. (cURus) E60693

Dimensions and weights

Depth	14.8 mm	Depth (inches)	0.5827 inch
Height	22.7 mm	Height (inches)	0.8937 inch
Height of lowest version	19.2 mm	Width	17.7 mm
Width (inches)	0.6968 inch	Net weight	4.91 g

Environmental Product Compliance

RoHS Compliance Status	Compliant without exemption
REACH SVHC	No SVHC above 0.1 wt%

System specifications

Number of poles	3	Solder pin length (l)	3.5 mm
Mounting onto the PCB	THT solder connection	Pitch in inches (P)	0.197 "
Side termination, characteristic	closed side	Solder eyelet hole diameter tolerance (D)+	0,1 mm
Transmission rate	10 / 100 Mbps	Number of solder pins per pole	2
Solder eyelet hole diameter (D)	1.1 mm	Product family	OMNIMATE Signal - series LMF
Pitch in mm (P)	5.00 mm	Protection degree	IP20
Performance-Category	10 / 100 Mbps	Soldering process	Manual soldering, Wave soldering
Solder pin dimensions	d = 0.8 mm	Tolerance of solder pin position	± 0.1 mm

Material data

Insulating material	Wemid (PA)	Colour	orange, coloured
Colour of operational elements	black	Colour chart (similar)	RAL 2000, -
Comparative Tracking Index (CTI)	≥ 600	Moisture Level (MSL)	
UL 94 flammability rating	V-0	Contact material	Cu-alloy
Contact surface	tinned	Coating	4-6 µm SN
Tinning type	matt	Layer structure of solder connection	4...6 µm Sn matt
Storage temperature, min.	-40 °C	Storage temperature, max.	70 °C
Operating temperature, min.	-50 °C	Operating temperature, max.	120 °C

Packing

Packaging	Box	VPE length	349.00 mm
VPE width	141.00 mm	VPE height	33.00 mm

Type tests

Test: Durability of markings	Standard	DIN EN 60512-1-1 / 01.03
	Test	mark of origin, type identification, pitch, approval marking UL, durability
	Evaluation	available

LMF APL 5.00/03/180 3.5SN BX

Weidmüller Interface GmbH & Co. KG
 Klingenbergstraße 26
 D-32758 Detmold
 Germany

www.weidmueller.com

Technical data

Test: Clampable cross section	Standard	DIN EN 60999-1 section 7 and 9.1 / 12.00, DIN EN 60947-1 section 8.2.4.5.1 / 12.02	
	Conductor type	Type of conductor and conductor cross-section	solid 0.14 mm ²
		Type of conductor and conductor cross-section	stranded 0.14 mm ²
		Type of conductor and conductor cross-section	solid 1.5 mm ²
		Type of conductor and conductor cross-section	stranded 1.5 mm ²
		Type of conductor and conductor cross-section	AWG 24/1
		Type of conductor and conductor cross-section	AWG 24/19
		Type of conductor and conductor cross-section	AWG 16/1
		Type of conductor and conductor cross-section	AWG 16/19
Evaluation	passed		
Test for damage to and accidental loosening of conductors	Standard	DIN EN 60999-1 section 9.4 / 12.00	
	Requirement	0.2 kg	
	Conductor type	Type of conductor and conductor cross-section	AWG 24/1
		Type of conductor and conductor cross-section	AWG 24/19
	Evaluation	passed	
	Requirement	0.3 kg	
	Conductor type	Type of conductor and conductor cross-section	stranded 0.25 mm ²
		Type of conductor and conductor cross-section	solid 0.5 mm ²
	Evaluation	passed	
	Requirement	0.4 kg	
Conductor type	Type of conductor and conductor cross-section	solid 1.5 mm ²	
	Type of conductor and conductor cross-section	stranded 1.5 mm ²	
	Type of conductor and conductor cross-section	AWG 16/1	
	Type of conductor and conductor cross-section	AWG 16/19	
Evaluation	passed		
Pull-out test	Standard	DIN EN 60999-1 section 9.5 / 12.00	
	Requirement	≥10 N	
	Conductor type	Type of conductor and conductor cross-section	AWG 24/1

LMF APL 5.00/03/180 3.5SN BX

Weidmüller Interface GmbH & Co. KG
 Klingenbergstraße 26
 D-32758 Detmold
 Germany

www.weidmueller.com

Technical data

	Type of conductor and conductor cross-section	AWG 24/19
Evaluation	passed	
Requirement	≥20 N	
Conductor type	Type of conductor and conductor cross-section	stranded 0.25 mm ²
	Type of conductor and conductor cross-section	H05V-K0.5
Evaluation	passed	
Requirement	≥40 N	
Conductor type	Type of conductor and conductor cross-section	H07V-U1.5
	Type of conductor and conductor cross-section	H07V-K1.5
	Type of conductor and conductor cross-section	AWG 16/1
	Type of conductor and conductor cross-section	AWG 16/19
Evaluation	passed	

Important note

IPC conformity Conformity: The products are developed, manufactured and delivered according international recognized standards and norms and comply with the assured properties in the data sheet resp. fulfill decorative properties in accordance with IPC-A-610 "Class 2". Further claims on the products can be evaluated on request.

- Notes**
- Additional variants on request
 - Rated current related to rated cross-section & min. No. of poles.
 - Wire end ferrule without plastic collar to DIN 46228/1
 - Wire end ferrule with plastic collar to DIN 46228/4
 - P on drawing = pitch
 - Rated data refer only to the component itself. Clearance and creepage distances to other components are to be designed in accordance with the relevant application standards.
 - The test point can only be used as potential-pickup point.
 - Long term storage of the product with average temperature of 50 °C and maximum humidity 70%, 36 months

Classifications

ETIM 8.0	EC002643	ETIM 9.0	EC002643
ETIM 10.0	EC002643	ECLASS 14.0	27-46-01-01
ECLASS 15.0	27-46-01-01		

LMF APL 5.00/03/180 3.5SN BX

Weidmüller Interface GmbH & Co. KG
 Klingenbergstraße 26
 D-32758 Detmold
 Germany

www.weidmueller.com

Drawings

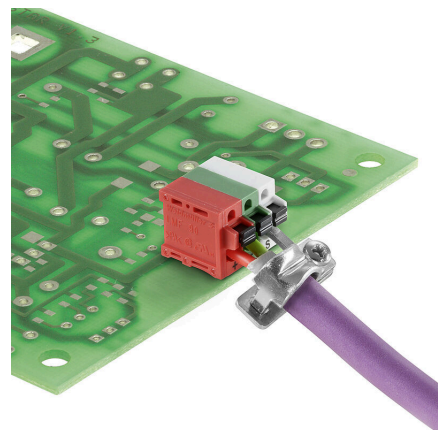
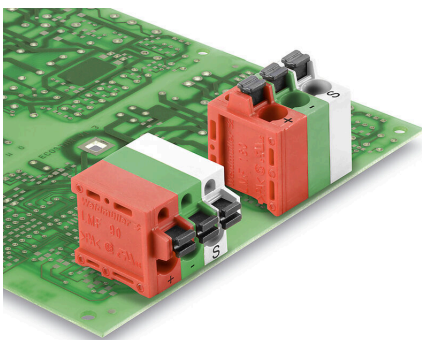
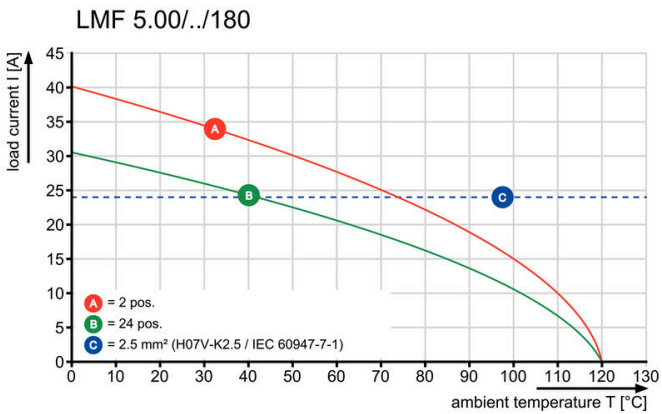
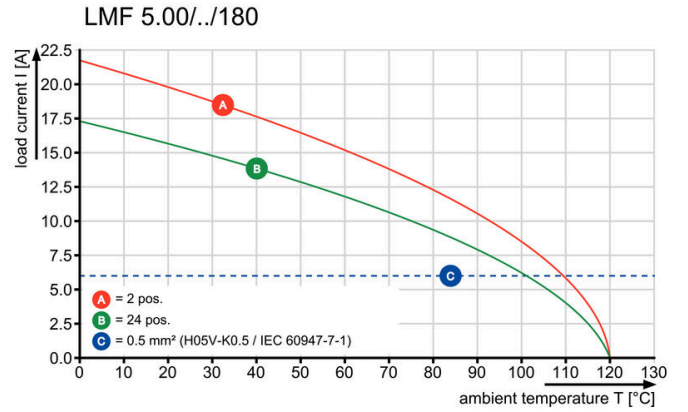
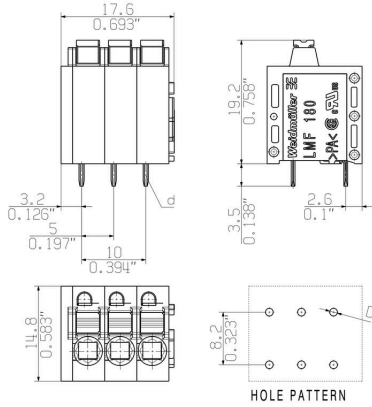

LMF APL 5.00/03/180 3.5Sn BX

Weidmüller Interface GmbH & Co. KG
Klingenbergstraße 26
D-32758 Detmold
Germany

Drawings

www.weidmueller.com

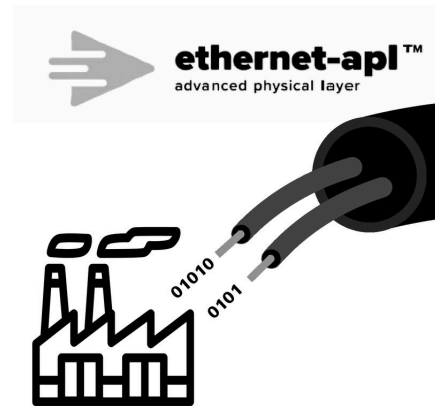

LMF APL 5.00/03/180 3.5SN BX

Weidmüller Interface GmbH & Co. KG
 Klingenbergstraße 26
 D-32758 Detmold
 Germany

www.weidmueller.com

Accessories

Slotted screwdriver



VDE insulated slot-head screwdriver, SDI DIN 7437, ISO 2380/2, drive output acc. to DIN 5264, ISO 2380/1.
 SoftFinish grip

General ordering data

Type	SDIS 0.6X3.5X100	Version	
Order No.	9008390000	Screwdriver, Screwdriver	
GTIN (EAN)	4032248056354		
Qty.	1 ST		

Additional accessories



No task is too small when creating the perfect solution. Connections form just one part of the overall process. Small details are often the key to the perfect solution in applications where potentials are tested, grouped or even isolated.

A system is not a system without small but essential details:

- Test plugs ensure reliable pick-up from diagnostic sockets

In tandem with the manufacturing process and application.

General ordering data

Type	PS 2.0 MC	Version	
Order No.	0310000000	PCB plug-in connector, Accessories, Test plug, red, Number of poles:	
GTIN (EAN)	4008190000059		
Qty.	20 ST		1

Ethernet-APL

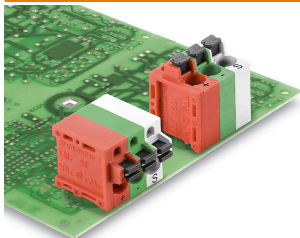

Features and benefits:

- Ethernet-APL compliant
- Space and weight saving design
- Cost-effective alternative to RJ45 and M12 connections
- Available with PUSH IN, SNAP IN, clamping yoke or tension spring connection
- Suitable for THT and THR soldering processes
- 10 Mbit/s communication for long ranges (1000m) according to IEEE 802.3cg-2019
- PoDL remote power supply according to IEEE 802.3bu
- Ethernet-APL is suitable for all IIoT devices and tailored for the process industry

LMF APL 5.00/03/180 3.5SN BX

Weidmüller Interface GmbH & Co. KG
Klingenbergstraße 26
D-32758 Detmold
Germany

www.weidmueller.com

Accessories

General ordering data

Type	SH ETH U	Version	
Order No.	2903230000	Shield clamp, Accessories, Screw flange, Number of poles: 1, zinc plated, Silver grey, Box	
GTIN (EAN)	4099986575172		
Qty.	25 ST		