

BLZP APL 5.00HC/03/180F SN OR BX

Weidmüller Interface GmbH & Co. KG
 Klingenbergstraße 26
 D-32758 Detmold
 Germany

www.weidmueller.com

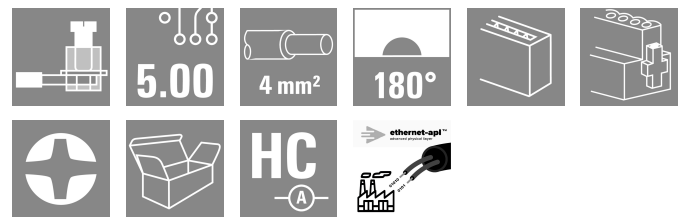
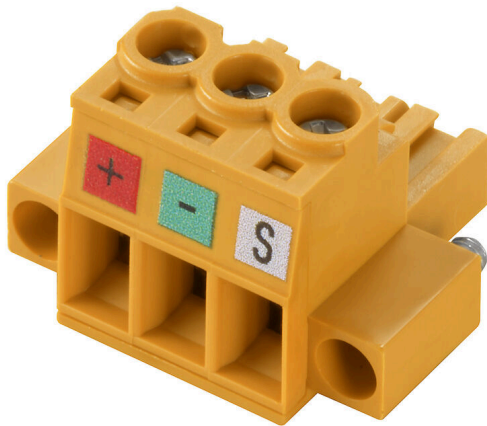

Features and benefits:

- Ethernet-APL compliant
- Space and weight saving design
- Cost-effective alternative to RJ45 and M12 connections
- Available with PUSH IN, SNAP IN, clamping yoke or tension spring connection
- Suitable for THT and THR soldering processes
- 10 Mbit/s communication for long ranges (1000m) according to IEEE 802.3cg-2019
- PoDL remote power supply according to IEEE 802.3bu
- Ethernet-APL is suitable for all IIoT devices and tailored for the process industry

General ordering data

Version	PCB plug-in connector, female plug, 5.00 mm, Number of poles: 3, 180°, Clamping yoke connection, Clamping range, max. : 4 mm², Box
Order No.	2872550000
Type	BLZP APL 5.00HC/03/180F SN OR BX
GTIN (EAN)	4064675641193
Qty.	72 items
Product data	IEC: 400 V / 23 A / 0.2 - 4 mm² UL: 300 V / 20 A / AWG 26 - AWG 12
Packaging	Box

BLZP APL 5.00HC/03/180F SN OR BX

Weidmüller Interface GmbH & Co. KG
 Klingenbergstraße 26
 D-32758 Detmold
 Germany

www.weidmueller.com

Technical data

Approvals

Approvals



ROHS Conform

UL File Number Search [UL Website](#)

Certificate No. (cURus) E60693

Dimensions and weights

Depth	20.1 mm	Depth (inches)	0.7913 inch
Height	16.1 mm	Height (inches)	0.6339 inch
Width	25 mm	Width (inches)	0.9842 inch
Net weight	6.69 g		

Environmental Product Compliance

RoHS Compliance Status	Compliant without exemption		
REACH SVHC	No SVHC above 0.1 wt%		
Product Carbon Footprint	Cradle to gate	0,187 kg CO2 eq.	

System specifications

Number of poles	3		
Pitch in inches (P)	0.197 "		
Side termination, characteristic	Flange		
Plugging force/pole, max.	10 N		
Transmission rate	10/100 MBit/s		
Pulling force/pole, max.	9 N		
Product family	OMNIMATE Signal - series BL/SL 5.00		
Pitch in mm (P)	5.00 mm		
Protection degree	IP20		
Plugging cycles	25		
Model	Socket connector		
Performance-Category	10/100 MBit/s		
Plugging force/pole, min.	6.00 N		
Tightening torque	Torque type		Wire connection
	Usage information		Tightening torque
			min. 0.4 Nm max. 0.5 Nm
	Torque type		Screw flange
Usage information		Tightening torque	
		min. 0.2 Nm max. 0.25 Nm	
Pulling force / pole, min.	6.00 N		

Electrical properties

Volume resistance $\leq 5 \text{ m}\Omega$

Material data

Insulating material	PBT	Colour	orange
Colour chart (similar)	RAL 2000	Insulating material group	IIIa
Comparative Tracking Index (CTI)	≥ 200	Moisture Level (MSL)	
UL 94 flammability rating	V-0	Contact material	Copper alloy
Contact surface	tinned	Layer structure of plug contact	4...8 μm Sn hot-dip tinned
Storage temperature, min.	-40 °C	Storage temperature, max.	70 °C

BLZP APL 5.00HC/03/180F SN OR BX

Weidmüller Interface GmbH & Co. KG
 Klingenbergstraße 26
 D-32758 Detmold
 Germany

www.weidmueller.com

Technical data

Operating temperature, min.	-50 °C	Operating temperature, max.	100 °C
-----------------------------	--------	-----------------------------	--------

Packing

Packaging	Box	VPE length	349.00 mm
VPE width	136.00 mm	VPE height	31.00 mm

Important note

IPC conformity
 Conformity: The products are developed, manufactured and delivered according international recognized standards and norms and comply with the assured properties in the data sheet resp. fulfill decorative properties in accordance with IPC-A-610 "Class 2". Further claims on the products can be evaluated on request.

- Notes**
- Additional variants on request
 - Gold-plated contact surfaces on request
 - Rated current related to rated cross-section & min. No. of poles.
 - Wire end ferrule without plastic collar to DIN 46228/1
 - Wire end ferrule with plastic collar to DIN 46228/4
 - P on drawing = pitch
 - Rated data refer only to the component itself. Clearance and creepage distances to other components are to be designed in accordance with the relevant application standards.
 - In accordance with IEC 61984, OMNIMATE-connectors are connectors without breaking capacity (COC). During designated use, connectors are not allowed to be engaged or disengaged when live or under load
 - Long term storage of the product with average temperature of 50 °C and maximum humidity 70%, 36 months

Classifications

ETIM 8.0	EC002638	ETIM 9.0	EC002638
ETIM 10.0	EC002638	ECLASS 14.0	27-46-02-02
ECLASS 15.0	27-46-02-02		

BLZP APL 5.00HC/03/180F SN OR BX

Weidmüller Interface GmbH & Co. KG
 Klingenbergstraße 26
 D-32758 Detmold
 Germany

www.weidmueller.com

Drawings

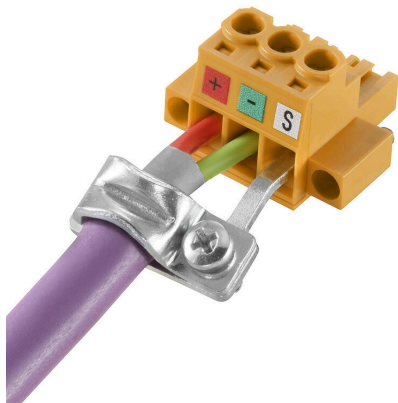
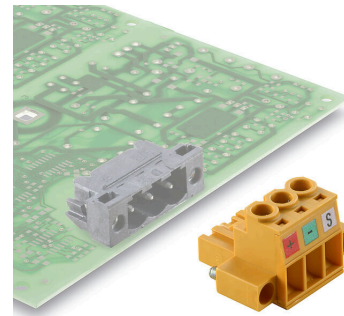
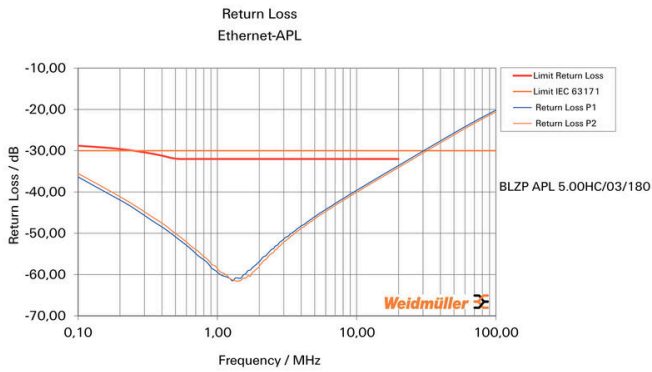
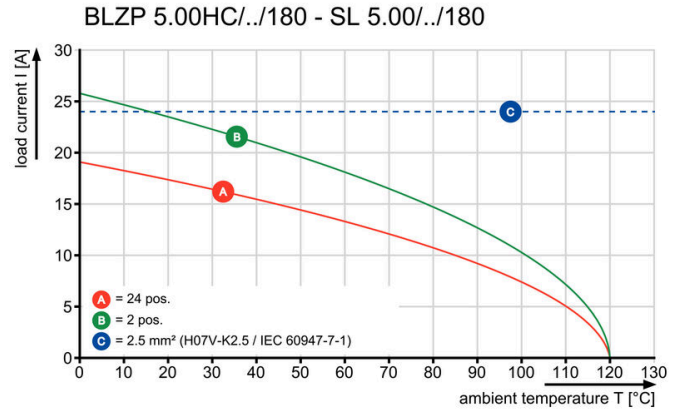
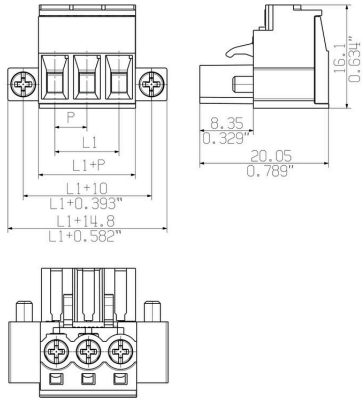

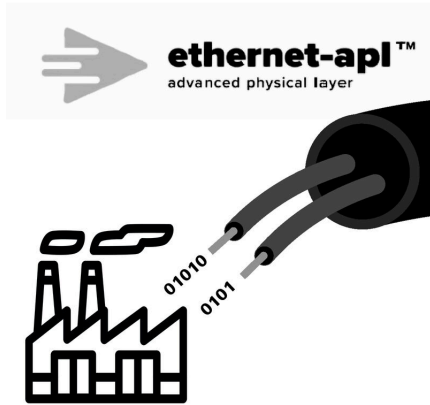

BLZP APL 5.00HC/03/180F SN OR BX

Weidmüller Interface GmbH & Co. KG
Klingenbergstraße 26
D-32758 Detmold
Germany

www.weidmueller.com

Accessories

Ethernet-APL

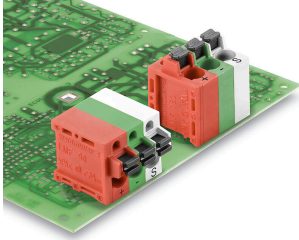

Features and benefits:

- Ethernet-APL compliant
- Space and weight saving design
- Cost-effective alternative to RJ45 and M12 connections
- Available with PUSH IN, SNAP IN, clamping yoke or tension spring connection
- Suitable for THT and THR soldering processes
- 10 Mbit/s communication for long ranges (1000m) according to IEEE 802.3cg-2019
- PoDL remote power supply according to IEEE 802.3bu
- Ethernet-APL is suitable for all IIoT devices and tailored for the process industry

General ordering data

Type	SH ETH U	Version
Order No.	2903230000	Shield clamp, Accessories, Screw flange, Number of poles: 1, zinc plated, Silver grey, Box
GTIN (EAN)	4099986575172	
Qty.	25 ST	

BLZP APL 5.00HC/03/180F SN OR BX

Weidmüller Interface GmbH & Co. KG
Klingenbergstraße 26
D-32758 Detmold
Germany

www.weidmueller.com

Counterpart

SL-SMT 5.00HC/180LF Box



High-temperature-resistant pin header, packed in box or tape. On tape, with 1.5 mm solder pin, optimised for automatic assembly. 3.2 mm solder pin suitable for reflow and wave soldering. The pin headers provide space for labelling and can be coded. HC = High Current.

General ordering data

Type	SL-SMT 5.00HC/03/180LF ...	Version
Order No.	1841400000	PCB plug-in connector, male header, Solder flange, THT/THR solder connection, 5.00 mm, Number of poles: 3, 180°, Solder pin length (l):
GTIN (EAN)	4032248352302	3.2 mm, tinned, black, Box
Qty.	72 ST	

SL-SMT 5.00HC/180LF Tape



High-temperature-resistant pin header, packed in box or tape. On tape, with 1.5 mm solder pin, optimised for automatic assembly. 3.2 mm solder pin suitable for reflow and wave soldering. The pin headers provide space for labelling and can be coded. HC = High Current.

General ordering data

Type	SL-SMT 5.00HC/03/180LF ...	Version
Order No.	1797940000	PCB plug-in connector, male header, Solder flange, THT/THR solder connection, 5.00 mm, Number of poles: 3, 180°, Solder pin length (l):
GTIN (EAN)	4032248239948	1.5 mm, tinned, black, Tape
Qty.	250 ST	

SL-SMT 5.00HC/90LF Box



High-temperature-resistant pin header, packed in box or tape. On tape, with 1.5 mm solder pin, optimised for automatic assembly. 3.2 mm solder pin suitable for reflow and wave soldering. The pin headers provide space for labelling and can be coded. HC = High Current.

General ordering data

Type	SL-SMT 5.00HC/03/90LF 3...	Version
Order No.	1306390000	PCB plug-in connector, male header, Solder flange, THT/THR solder connection, 5.00 mm, Number of poles: 3, 90°, Solder pin length (l):
GTIN (EAN)	4050118108798	3.2 mm, Gold-plated, black, Box
Qty.	72 ST	

BLZP APL 5.00HC/03/180F SN OR BX

Weidmüller Interface GmbH & Co. KG
Klingenbergstraße 26
D-32758 Detmold
Germany

www.weidmueller.com

Counterpart

Type	SL-SMT 5.00HC/03/90LF 3...	Version
Order No.	1840360000	PCB plug-in connector, male header, Solder flange, THT/THR solder
GTIN (EAN)	4032248351107	connection, 5.00 mm, Number of poles: 3, 90°, Solder pin length (l):
Qty.	72 ST	3.2 mm, tinned, black, Box

SL-SMT 5.00HC/90LF Tape



High-temperature-resistant pin header, packed in box or tape. On tape, with 1.5 mm solder pin, optimised for automatic assembly. 3.2 mm solder pin suitable for reflow and wave soldering. The pin headers provide space for labelling and can be coded. HC = High Current.

General ordering data

Type	SL-SMT 5.00HC/03/90LF 1...	Version
Order No.	1797760000	PCB plug-in connector, male header, Solder flange, THT/THR solder
GTIN (EAN)	4032248239764	connection, 5.00 mm, Number of poles: 3, 90°, Solder pin length (l):
Qty.	350 ST	1.5 mm, tinned, black, Tape

SL 5.00/180B

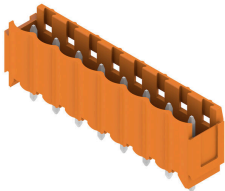

Male connectors with straight outlet direction. The solder pin length is optimised for wave flow soldering. The pin headers provide space for labelling and can be coded.

General ordering data

Type	SL 5.00/03/180B 3.2SN O...	Version
Order No.	1581790000	PCB plug-in connector, male header, Dovetails for fixing blocks, THT
GTIN (EAN)	4008190185169	solder connection, 5.00 mm, Number of poles: 3, 180°, Solder pin
Qty.	100 ST	length (l): 3.2 mm, tinned, orange, Box

BLZP APL 5.00HC/03/180F SN OR BX

Weidmüller Interface GmbH & Co. KG
 Klingenbergstraße 26
 D-32758 Detmold
 Germany

Counterpart

www.weidmueller.com

SL 5.00/90B

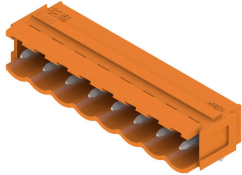

Male connectors with 90° outlet direction. The solder pin length is optimised for wave flow soldering. The pin headers provide space for labelling and can be coded.

General ordering data

Type	SL 5.00/03/90B 3.2SN OR...	Version
Order No.	1580870000	PCB plug-in connector, male header, Dovetails for fixing blocks, THT
GTIN (EAN)	4008190008482	solder connection, 5.00 mm, Number of poles: 3, 90°, Solder pin
Qty.	100 ST	length (l): 3.2 mm, tinned, orange, Box