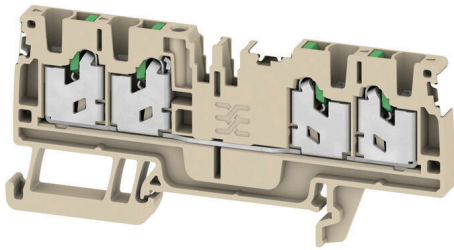

S4C 2.5 DL**Weidmüller Interface GmbH & Co. KG**

Klingenbergstraße 26

D-32758 Detmold

Germany

www.weidmueller.com

To feed through power, signal, and data is the classical requirement in electrical engineering and panel building. The insulating material, the connection system and the design of the terminal blocks are the differentiating features. A feed-through terminal block is suitable for joining and/or connecting one or more conductors. They could have one or more connection levels that are on the same potential or insulated against one another.

General ordering data

Version	Feed-through terminal block, SNAP IN, dark beige, 2.5 mm ² , 24 A, 800 V, Number of connections: 4
Order No.	2862980000
Type	S4C 2.5 DL
GTIN (EAN)	4064675594031
Qty.	100 items

S4C 2.5 DL

Weidmüller Interface GmbH & Co. KG
 Klingenbergstraße 26
 D-32758 Detmold
 Germany

www.weidmueller.com

Technical data

Approvals

Approvals



ROHS	Conform
UL File Number Search	UL Website
Certificate No. (cURus)	E60693
Certificate No. (cURusEX)	E184763

Dimensions and weights

Depth	38 mm	Depth (inches)	1.4961 inch
Height	84 mm	Height (inches)	3.3071 inch
Width	5.1 mm	Width (inches)	0.2008 inch
Net weight	14.06 g		

Temperatures

Storage temperature	-25 °C...55 °C	Continuous operating temp., min.	-60 °C
Continuous operating temp., max.	130 °C		

Environmental Product Compliance

RoHS Compliance Status	Compliant without exemption
REACH SVHC	No SVHC above 0.1 wt%

Material data

Basic material	Wemid	Colour	dark beige
Colour of operational elements	green	UL 94 flammability rating	V-0

Rating data IECEx/ATEX

Certificate No. (ATEX)	TUEV22ATEX8925U	Certificate No. (IECEX)	IECEXTUR22.0073U
Max. voltage (ATEX)	550 V	Current (ATEX)	21 A
Wire cross section max. (ATEX)	2.5 mm ²		

System specifications

End cover plate required	Yes	Number of potentials	1
Number of levels	1	Number of clamping points per level	4
Number of potentials per tier	1	Levels cross-connected internally	No
Mounting rail	TS 35	N-function	No
PE function	No	PEN function	No

Additional technical data

Open sides	right	Snap-on	Yes
Type of fixing	Snap-on	Explosion-tested version	No
Type of mounting	Snap-on		

S4C 2.5 DL

Weidmüller Interface GmbH & Co. KG

Klingenbergstraße 26
D-32758 Detmold
Germany

www.weidmueller.com

Technical data

CSA rating data

Wire cross section max. (CSA)	14 AWG	Voltage size C (CSA)	600 V
Current size C (CSA)	15 A	Certificate No. (CSA)	200039-8116541
Voltage size B (CSA)	600 V	Current size B (CSA)	15 A
Voltage size D (CSA)	600 V	Current size D (CSA)	5 A
Wire cross section min. (CSA)	20 AWG		

Conductors for clamping (additional connection)

Connection type, additional connection SNAP IN

Conductors for clamping (rated connection)

Gauge to IEC 60947-1	A2	
Wire connection cross section AWG, max.	AWG 14	
Connection direction	top	
Stripping length	10 mm	
Type of connection	SNAP IN	
Number of connections	4	
Clamping range, max.	2.5 mm ²	
Clamping range, min.	0.34 mm ²	
Blade size	0.6 x 3.5 mm	
Wire connection cross section AWG, min.	AWG 22	
Wire connection cross-section, finely stranded with wire-end ferrules DIN 46228/4, max.	2.5 mm ²	
Wire connection cross-section, finely stranded with wire-end ferrules DIN 46228/4, min.	0.34 mm ²	
Wire connection cross-section, finely stranded with wire-end ferrules DIN 46228/1, max.	2.5 mm ²	
Wire connection cross-section, finely stranded with wire-end ferrules DIN 46228/1, min.	0.34 mm ²	
Wire connection cross section, finely stranded, max.	4 mm ²	
Wire connection cross section, finely stranded, min.	0.34 mm ²	
Connection cross-section, stranded, max.	2.5 mm ²	
Connection cross-section, stranded, min.	0.34 mm ²	
Twin wire-end ferrules, max.	0.75 mm ²	
Twin wire-end ferrules, min.	0.5 mm ²	
Wire connection cross-section, solid core, max.	2.5 mm ²	
Wire connection cross-section, solid core, min.	0.34 mm ²	
Connection cross-section, finely stranded, min.	0.34 mm ²	
Tube length for wire-end ferrule with plastic collar acc. to cross-section	Cross-section, min.	0.25 mm ²
	Cross-section, max.	0.34 mm ²
	Tube length, min.	8 mm
	Tube length, max.	8 mm
	Cross-section, min.	0.5 mm ²
	Cross-section, max.	1 mm ²
	Tube length, min.	8 mm

S4C 2.5 DL

Weidmüller Interface GmbH & Co. KG

Klingenbergstraße 26
D-32758 Detmold
Germany

www.weidmueller.com

Technical data

	Tube length, max.	12 mm
	Cross-section, min.	1.5 mm ²
	Cross-section, max.	2.5 mm ²
	Tube length, min.	10 mm
	Tube length, max.	18 mm
Tube length for wire-end ferrule without plastic collar acc. to cross-section	Cross-section, min.	0.5 mm ²
	Cross-section, max.	1 mm ²
	Tube length, min.	10 mm
	Tube length, max.	10 mm
	Cross-section, min.	1.5 mm ²
	Cross-section, max.	2.5 mm ²
	Tube length, min.	10 mm
	Tube length, max.	18 mm
Tube length for twin wire-end ferrule acc. to cross-section	Cross-section, min.	0.5 mm ²
	Cross-section, max.	0.5 mm ²
	Tube length, min.	8 mm
	Tube length, max.	12 mm
	Cross-section, min.	0.75 mm ²
	Cross-section, max.	0.75 mm ²
	Tube length, min.	18 mm
	Tube length, max.	18 mm

General

Wire connection cross section AWG, max.	AWG 14	Wire connection cross section AWG, min.	AWG 22
Standards	IEC 60947-7-1	Mounting rail	TS 35

Rating data

Rated cross-section	2.5 mm ²	Rated voltage	800 V
Rated DC voltage	800 V	Nominal current	24 A
Current at maximum wires	24 A	Standards	IEC 60947-7-1
Volume resistance according to IEC 60947-7-x	1.33 mΩ	Rated impulse withstand voltage	8 kV
Power loss in accordance with IEC 60947-7-x	0.77 W	Surge voltage category	III
Pollution severity	3		

UL rating data

Conductor size Factory wiring max. (cURus)	12 AWG	Voltage size B (cURus)	600 V
Voltage size D (cURus)	600 V	Certificate No. (cURus)	E60693
Conductor size Field wiring min. (cURus)	22 AWG	Conductor size Factory wiring min. (cURus)	22 AWG
Current size B (cURus)	20 A	Voltage size C (cURus)	600 V
Current size C (cURus)	20 A	Current size D (cURus)	5 A
Conductor size Field wiring max. (cURus)	12 AWG		

Classifications

ETIM 8.0	EC000897	ETIM 9.0	EC000897
ETIM 10.0	EC000897	ECLASS 14.0	27-25-01-01
ECLASS 15.0	27-25-01-01		

Drawings

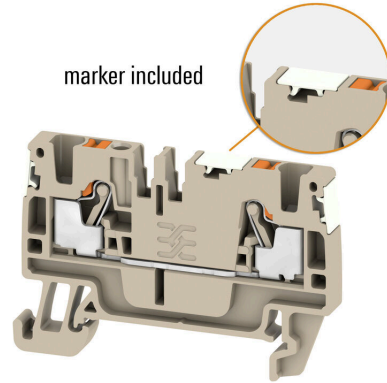
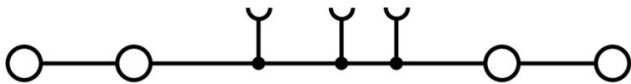

S4C 2.5 DL

Weidmüller Interface GmbH & Co. KG
 Klingenbergstraße 26
 D-32758 Detmold
 Germany

www.weidmueller.com

Accessories

End bracket

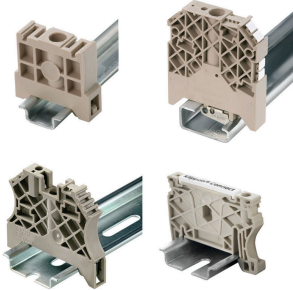

Weidmüller's range of products includes end brackets that guarantee a permanent, reliable mounting on the terminal rail and prevent sliding. Versions with and without screws are available. The end brackets include marking options, also for group markers, and also a test plug holder.

General ordering data

Type	AEB 35 SC/1	Version	
Order No.	1991920000	Version	A-series, End bracket
GTIN (EAN)	4050118376722		
Qty.	50 ST		

Testadapter and testsockets



Test adapters and test plugs are used for the electrical connection between terminal blocks and the test equipment. In this way, an electrical contact can be established in the wired state and measurements can be done easily.

General ordering data

Type	ATPG 2.5 MI-R	Version	
Order No.	1991960000	Version	Test adapter (terminal), 1.5 mm ² , 250 V, 0.2 A
GTIN (EAN)	4050118376685		
Qty.	50 ST		
Type	ATPG 2.5/3	Version	
Order No.	2041190000	Version	Test adapter (terminal), 1.5 mm ² , 250 V, 0.2 A
GTIN (EAN)	4050118409604		
Qty.	25 ST		
Type	ATPG 2.5/5	Version	
Order No.	2041180000	Version	Test adapter (terminal), 1.5 mm ² , 250 V, 0.2 A
GTIN (EAN)	4050118409505		
Qty.	25 ST		
Type	ATPG 1.5-10 L	Version	
Order No.	1991890000	Version	Test adapter (terminal), 1.5 mm ² , 250 V, 0.2 A
GTIN (EAN)	4050118376647		
Qty.	50 ST		

S4C 2.5 DL

Weidmüller Interface GmbH & Co. KG
 Klingenbergstraße 26
 D-32758 Detmold
 Germany

Accessories

www.weidmueller.com

Cross-connections



The distribution or multiplication of a potential to adjoining terminal blocks is realized via a cross-connection. Additional wiring effort can be easily avoided. Even if the poles are broken out, contact reliability in the terminal blocks is still ensured. Our portfolio offers pluggable and screwable cross-connection systems for modular terminal blocks.

General ordering data

Type	ZQV 2.5N/10	Version
Order No.	1527690000	Cross-connector (terminal), Plugged, orange, 24 A, Number of poles:
GTIN (EAN)	4050118447989	10, Pitch in mm (P): 5.10, Insulated: Yes, Width: 48.7 mm
Qty.	20 ST	
Type	ZQV 2.5N/10 BL	Version
Order No.	1527880000	Cross-connector (terminal), Plugged, blue, 24 A, Number of poles: 10,
GTIN (EAN)	4050118448573	Pitch in mm (P): 5.10, Insulated: Yes, Width: 48.7 mm
Qty.	20 ST	
Type	ZQV 2.5N/10 RD	Version
Order No.	2108910000	Cross-connector (terminal), Plugged, red, 24 A, Number of poles: 10,
GTIN (EAN)	4050118486018	Pitch in mm (P): 5.10, Insulated: Yes, Width: 48.7 mm
Qty.	20 ST	
Type	ZQV 2.5N/2	Version
Order No.	1527540000	Cross-connector (terminal), Plugged, orange, 24 A, Number of poles:
GTIN (EAN)	4050118448467	2, Pitch in mm (P): 5.10, Insulated: Yes, Width: 7.9 mm
Qty.	60 ST	
Type	ZQV 2.5N/2 BL	Version
Order No.	1527740000	Cross-connector (terminal), Plugged, blue, 24 A, Number of poles: 2,
GTIN (EAN)	4050118448658	Pitch in mm (P): 5.10, Insulated: Yes, Width: 7.9 mm
Qty.	60 ST	
Type	ZQV 2.5N/2 RD	Version
Order No.	2108470000	Cross-connector (terminal), Plugged, red, 24 A, Number of poles: 2,
GTIN (EAN)	4050118448542	Pitch in mm (P): 5.10, Insulated: Yes, Width: 7.9 mm
Qty.	60 ST	
Type	ZQV 2.5N/20	Version
Order No.	1527720000	Cross-connector (terminal), Plugged, orange, 24 A, Number of poles:
GTIN (EAN)	4050118447972	20, Pitch in mm (P): 5.10, Insulated: Yes, Width: 102 mm
Qty.	20 ST	
Type	ZQV 2.5N/20 BL	Version
Order No.	1527890000	Cross-connector (terminal), Plugged, blue, 24 A, Number of poles: 20,
GTIN (EAN)	4050118448566	Pitch in mm (P): 5.10, Insulated: Yes, Width: 102 mm
Qty.	20 ST	
Type	ZQV 2.5N/20 RD	Version
Order No.	2108920000	Cross-connector (terminal), Plugged, red, 24 A, Number of poles: 20,
GTIN (EAN)	4050118485899	Pitch in mm (P): 5.10, Insulated: Yes, Width: 102 mm
Qty.	20 ST	
Type	ZQV 2.5N/3	Version
Order No.	1527570000	Cross-connector (terminal), Plugged, orange, 24 A, Number of poles:
GTIN (EAN)	4050118448450	3, Pitch in mm (P): 5.10, Insulated: Yes, Width: 13 mm
Qty.	60 ST	

S4C 2.5 DL

Weidmüller Interface GmbH & Co. KG
 Klingenbergstraße 26
 D-32758 Detmold
 Germany

www.weidmueller.com

Accessories

Type	ZQV 2.5N/3 BL	Version
Order No.	1527770000	Cross-connector (terminal), Plugged, blue, 24 A, Number of poles: 3,
GTIN (EAN)	4050118448641	Pitch in mm (P): 5.10, Insulated: Yes, Width: 13 mm
Qty.	60 ST	
Type	ZQV 2.5N/3 RD	Version
Order No.	2108690000	Cross-connector (terminal), Plugged, red, 24 A, Number of poles: 3,
GTIN (EAN)	4050118448535	Pitch in mm (P): 5.10, Insulated: Yes, Width: 13 mm
Qty.	60 ST	
Type	ZQV 2.5N/4	Version
Order No.	1527590000	Cross-connector (terminal), Plugged, orange, 24 A, Number of poles: 4,
GTIN (EAN)	4050118448443	Pitch in mm (P): 5.10, Insulated: Yes, Width: 18.1 mm
Qty.	60 ST	
Type	ZQV 2.5N/4 BL	Version
Order No.	1527780000	Cross-connector (terminal), Plugged, blue, 24 A, Number of poles: 4,
GTIN (EAN)	4050118448634	Pitch in mm (P): 5.10, Insulated: Yes, Width: 18.1 mm
Qty.	60 ST	
Type	ZQV 2.5N/4 RD	Version
Order No.	2108700000	Cross-connector (terminal), Plugged, red, 24 A, Number of poles: 4,
GTIN (EAN)	4050118448528	Pitch in mm (P): 5.10, Insulated: Yes, Width: 18.1 mm
Qty.	60 ST	
Type	ZQV 2.5N/5	Version
Order No.	1527620000	Cross-connector (terminal), Plugged, orange, 24 A, Number of poles: 5,
GTIN (EAN)	4050118448436	Pitch in mm (P): 5.10, Insulated: Yes, Width: 23.2 mm
Qty.	20 ST	
Type	ZQV 2.5N/5 BL	Version
Order No.	1527790000	Cross-connector (terminal), Plugged, blue, 24 A, Number of poles: 5,
GTIN (EAN)	4050118448627	Pitch in mm (P): 5.10, Insulated: Yes, Width: 23.2 mm
Qty.	20 ST	
Type	ZQV 2.5N/5 RD	Version
Order No.	2108710000	Cross-connector (terminal), Plugged, red, 24 A, Number of poles: 5,
GTIN (EAN)	4050118448511	Pitch in mm (P): 5.10, Insulated: Yes, Width: 23.2 mm
Qty.	20 ST	
Type	ZQV 2.5N/50	Version
Order No.	1527730000	Cross-connector (terminal), Plugged, orange, 24 A, Number of poles: 50,
GTIN (EAN)	4050118411362	Pitch in mm (P): 5.10, Insulated: Yes, Width: 255 mm
Qty.	5 ST	
Type	ZQV 2.5N/50 BL	Version
Order No.	1527920000	Cross-connector (terminal), Plugged, blue, 24 A, Number of poles: 50,
GTIN (EAN)	4050118448559	Pitch in mm (P): 5.10, Insulated: Yes, Width: 255 mm
Qty.	5 ST	
Type	ZQV 2.5N/50 RD	Version
Order No.	2109000000	Cross-connector (terminal), Plugged, red, 24 A, Number of poles: 50,
GTIN (EAN)	4050118486001	Pitch in mm (P): 5.10, Insulated: Yes, Width: 255 mm
Qty.	5 ST	
Type	ZQV 2.5N/6	Version
Order No.	1527630000	Cross-connector (terminal), Plugged, orange, 24 A, Number of poles: 6,
GTIN (EAN)	4050118448429	Pitch in mm (P): 5.10, Insulated: Yes, Width: 28.3 mm
Qty.	20 ST	
Type	ZQV 2.5N/6 BL	Version
Order No.	1527820000	Cross-connector (terminal), Plugged, blue, 24 A, Number of poles: 6,
GTIN (EAN)	4050118448610	Pitch in mm (P): 5.10, Insulated: Yes, Width: 28.3 mm
Qty.	20 ST	

S4C 2.5 DL

Weidmüller Interface GmbH & Co. KG

Klingenbergstraße 26

D-32758 Detmold

Germany

www.weidmueller.com

Accessories

Type	ZQV 2.5N/6 RD	Version
Order No.	2108720000	Cross-connector (terminal), Plugged, red, 24 A, Number of poles: 6,
GTIN (EAN)	4050118448504	Pitch in mm (P): 5.10, Insulated: Yes, Width: 28.3 mm
Qty.	20 ST	
Type	ZQV 2.5N/7	Version
Order No.	1527640000	Cross-connector (terminal), Plugged, orange, 24 A, Number of poles:
GTIN (EAN)	4050118448412	7, Pitch in mm (P): 5.10, Insulated: Yes, Width: 33.4 mm
Qty.	20 ST	
Type	ZQV 2.5N/7 BL	Version
Order No.	1527830000	Cross-connector (terminal), Plugged, blue, 24 A, Number of poles: 7,
GTIN (EAN)	4050118448603	Pitch in mm (P): 5.10, Insulated: Yes, Width: 33.4 mm
Qty.	20 ST	
Type	ZQV 2.5N/7 RD	Version
Order No.	2108810000	Cross-connector (terminal), Plugged, red, 24 A, Number of poles: 7,
GTIN (EAN)	4050118448498	Pitch in mm (P): 5.10, Insulated: Yes, Width: 33.4 mm
Qty.	20 ST	
Type	ZQV 2.5N/8	Version
Order No.	1527670000	Cross-connector (terminal), Plugged, orange, 24 A, Number of poles:
GTIN (EAN)	4050118448405	8, Pitch in mm (P): 5.10, Insulated: Yes, Width: 38.5 mm
Qty.	20 ST	
Type	ZQV 2.5N/8 BL	Version
Order No.	1527840000	Cross-connector (terminal), Plugged, blue, 24 A, Number of poles: 8,
GTIN (EAN)	4050118448597	Pitch in mm (P): 5.10, Insulated: Yes, Width: 38.5 mm
Qty.	20 ST	
Type	ZQV 2.5N/8 RD	Version
Order No.	2108870000	Cross-connector (terminal), Plugged, red, 24 A, Number of poles: 8,
GTIN (EAN)	4050118448481	Pitch in mm (P): 5.10, Insulated: Yes, Width: 38.5 mm
Qty.	20 ST	
Type	ZQV 2.5N/9	Version
Order No.	1527680000	Cross-connector (terminal), Plugged, orange, 24 A, Number of poles:
GTIN (EAN)	4050118447996	9, Pitch in mm (P): 5.10, Insulated: Yes, Width: 43.6 mm
Qty.	20 ST	
Type	ZQV 2.5N/9 BL	Version
Order No.	1527870000	Cross-connector (terminal), Plugged, blue, 24 A, Number of poles: 9,
GTIN (EAN)	4050118448580	Pitch in mm (P): 5.10, Insulated: Yes, Width: 43.6 mm
Qty.	20 ST	
Type	ZQV 2.5N/9 RD	Version
Order No.	2108900000	Cross-connector (terminal), Plugged, red, 24 A, Number of poles: 9,
GTIN (EAN)	4050118448474	Pitch in mm (P): 5.10, Insulated: Yes, Width: 43.6 mm
Qty.	20 ST	

S4C 2.5 DL

Weidmüller Interface GmbH & Co. KG

Klingenbergstraße 26

D-32758 Detmold

Germany

Accessories

www.weidmueller.com

Blank



The Dekafix (DEK) marker is the universal marker for all conductor and plug-in connectors as well as for electronic sub-assemblies. The system is ideal for short number sequences and covers a wide range of ready-printed markers.

Strips for fast installation in only one work step. The printing is easy to read, rich in contrast and available in various widths.

- Large range of ready-to-use markers
 - Strips for fast installation
 - Terminal markers, suitable for all Weidmüller cable connectors
 - Available as blank MultiCard or with standard printing
- For custom printing: Please send us a file of our labeling software M-Print PRO or M-Print PRO Online (without installation) for your labeling specifications.

General ordering data

Type	DEK 5/5 MC NE BR	Version	
Order No.	1249870000		Dekafix, Terminal marker, 5 x 5 mm, Pitch in mm (P): 5.00
GTIN (EAN)	4050118051865		Weidmueller, brown
Qty.	1000 ST		

V0



The Dekafix (DEK) marker is the universal marker for all conductor and plug-in connectors as well as for electronic sub-assemblies. The system is ideal for short number sequences and covers a wide range of ready-printed markers.

Strips for fast installation in only one work step. The printing is easy to read, rich in contrast and available in various widths.

- Large range of ready-to-use markers
 - Strips for fast installation
 - Terminal markers, suitable for all Weidmüller cable connectors
 - Available as blank MultiCard or with standard printing
- For custom printing: Please send us a file of our labeling software M-Print PRO or M-Print PRO Online (without installation) for your labeling specifications.

General ordering data

Type	DEK 5/5 MC NE V0 WS	Version	
Order No.	1388530000		Dekafix, Terminal marker, 5 x 5 mm, Pitch in mm (P): 5.00
GTIN (EAN)	4050118188622		Weidmueller, white
Qty.	1000 ST		

S4C 2.5 DL

Weidmüller Interface GmbH & Co. KG

Klingenbergstraße 26

D-32758 Detmold

Germany

Accessories

www.weidmueller.com

Blank



The Dekafix (DEK) marker is the universal marker for all conductor and plug-in connectors as well as for electronic sub-assemblies. The system is ideal for short number sequences and covers a wide range of ready-printed markers.

Strips for fast installation in only one work step. The printing is easy to read, rich in contrast and available in various widths.

- Large range of ready-to-use markers
 - Strips for fast installation
 - Terminal markers, suitable for all Weidmüller cable connectors
 - Available as blank MultiCard or with standard printing
- For custom printing: Please send us a file of our labeling software M-Print PRO or M-Print PRO Online (without installation) for your labeling specifications.

General ordering data

Type	DEK 5/5 MC NE VI	Version	
Order No.	1249860000		Dekafix, Terminal marker, 5 x 5 mm, Pitch in mm (P): 5.00
GTIN (EAN)	4050118042764		Weidmueller, violet
Qty.	1000 ST		

Custom printing



The Dekafix (DEK) marker is the universal marker for all conductor and plug-in connectors as well as for electronic sub-assemblies. The system is ideal for short number sequences and covers a wide range of ready-printed markers.

Strips for fast installation in only one work step. The printing is easy to read, rich in contrast and available in various widths.

- Large range of ready-to-use markers
 - Strips for fast installation
 - Terminal markers, suitable for all Weidmüller cable connectors
 - Available as blank MultiCard or with standard printing
- For custom printing: Please send us a file of our labeling software M-Print PRO or M-Print PRO Online (without installation) for your labeling specifications.

General ordering data

Type	DEK 5/5 MC SDR	Version	
Order No.	1609810000		Dekafix, Terminal marker, 5 x 5 mm, Pitch in mm (P): 5.00
GTIN (EAN)	4008190456597		Weidmueller, To customer specification
Qty.	200 ST		

S4C 2.5 DL

Weidmüller Interface GmbH & Co. KG

Klingenbergstraße 26

D-32758 Detmold

Germany

Accessories

www.weidmueller.com

Blank



The Dekafix (DEK) marker is the universal marker for all conductor and plug-in connectors as well as for electronic sub-assemblies. The system is ideal for short number sequences and covers a wide range of ready-printed markers.

Strips for fast installation in only one work step. The printing is easy to read, rich in contrast and available in various widths.

- Large range of ready-to-use markers
 - Strips for fast installation
 - Terminal markers, suitable for all Weidmüller cable connectors
 - Available as blank MultiCard or with standard printing
- For custom printing: Please send us a file of our labeling software M-Print PRO or M-Print PRO Online (without installation) for your labeling specifications.

General ordering data

Type	DEK 5/5 MC NE BL	Version
Order No.	1609801693	Dekafix, Terminal marker, 5 x 5 mm, Pitch in mm (P): 5.00
GTIN (EAN)	4008190397166	Weidmueller, blue
Qty.	1000 ST	
Type	DEK 5/5 MC NE GE	Version
Order No.	1609801687	Dekafix, Terminal marker, 5 x 5 mm, Pitch in mm (P): 5.00
GTIN (EAN)	4008190397135	Weidmueller, yellow
Qty.	1000 ST	
Type	DEK 5/5 MC NE GN	Version
Order No.	1609801688	Dekafix, Terminal marker, 5 x 5 mm, Pitch in mm (P): 5.00
GTIN (EAN)	4008190397142	Weidmueller, green
Qty.	1000 ST	
Type	DEK 5/5 MC NE GR	Version
Order No.	1609801691	Dekafix, Terminal marker, 5 x 5 mm, Pitch in mm (P): 5.00
GTIN (EAN)	4008190397159	Weidmueller, grey
Qty.	1000 ST	
Type	DEK 5/5 MC NE OR	Version
Order No.	1238340000	Dekafix, Terminal marker, 5 x 5 mm, Pitch in mm (P): 5.00
GTIN (EAN)	4050118062632	Weidmueller, orange
Qty.	1000 ST	
Type	DEK 5/5 MC NE RT	Version
Order No.	1609801686	Dekafix, Terminal marker, 5 x 5 mm, Pitch in mm (P): 5.00
GTIN (EAN)	4008190397128	Weidmueller, red
Qty.	1000 ST	
Type	DEK 5/5 MC NE SW	Version
Order No.	1457550000	Dekafix, Terminal marker, 5 x 5 mm, Pitch in mm (P): 5.00
GTIN (EAN)	4050118263817	Weidmueller, black
Qty.	1000 ST	
Type	DEK 5/5 MC NE WS	Version
Order No.	1609801044	Dekafix, Terminal marker, 5 x 5 mm, Pitch in mm (P): 5.00
GTIN (EAN)	4008190397111	Weidmueller, white
Qty.	1000 ST	

S4C 2.5 DL

Weidmüller Interface GmbH & Co. KG

Klingenbergstraße 26

D-32758 Detmold

Germany

Accessories

www.weidmueller.com

Plus



The Dekafix (DEK) marker is the universal marker for all conductor and plug-in connectors as well as for electronic sub-assemblies. The system is ideal for short number sequences and covers a wide range of ready-printed markers.

Strips for fast installation in only one work step. The printing is easy to read, rich in contrast and available in various widths.

- Large range of ready-to-use markers
 - Strips for fast installation
 - Terminal markers, suitable for all Weidmüller cable connectors
 - Available as blank MultiCard or with standard printing
- For custom printing: Please send us a file of our labeling software M-Print PRO or M-Print PRO Online (without installation) for your labeling specifications.

General ordering data

Type	DEK 5/5 PLUS MC NE GE	Version
Order No.	1907520000	Dekafix, Terminal marker, 5 x 5 mm, Pitch in mm (P): 5.00
GTIN (EAN)	4032248532100	Weidmueller, yellow
Qty.	1000 ST	
Type	DEK 5/5 PLUS MC NE WS	Version
Order No.	1854490000	Dekafix, Terminal marker, 5 x 5 mm, Pitch in mm (P): 5.00
GTIN (EAN)	4032248393596	Weidmueller, white
Qty.	1000 ST	

Custom printing



The Dekafix (DEK) marker is the universal marker for all conductor and plug-in connectors as well as for electronic sub-assemblies. The system is ideal for short number sequences and covers a wide range of ready-printed markers.

Strips for fast installation in only one work step. The printing is easy to read, rich in contrast and available in various widths.

- Large range of ready-to-use markers
 - Strips for fast installation
 - Terminal markers, suitable for all Weidmüller cable connectors
 - Available as blank MultiCard or with standard printing
- For custom printing: Please send us a file of our labeling software M-Print PRO or M-Print PRO Online (without installation) for your labeling specifications.

General ordering data

Type	DEK 5/5 PLUS MC SDR	Version
Order No.	1854500000	Dekafix, Terminal marker, 5 x 5 mm, Pitch in mm (P): 5.00
GTIN (EAN)	4032248393602	Weidmueller, To customer specification
Qty.	200 ST	

S4C 2.5 DL

Weidmüller Interface GmbH & Co. KG

Klingenbergstraße 26
D-32758 Detmold
Germany

www.weidmueller.com

Accessories

Blank



The Dekafix (DEK) marker is the universal marker for all conductor and plug-in connectors as well as for electronic sub-assemblies. The system is ideal for short number sequences and covers a wide range of ready-printed markers.

Strips for fast installation in only one work step. The printing is easy to read, rich in contrast and available in various widths.

- Large range of ready-to-use markers
 - Strips for fast installation
 - Terminal markers, suitable for all Weidmüller cable connectors
 - Available as blank MultiCard or with standard printing
- For custom printing: Please send us a file of our labeling software M-Print PRO or M-Print PRO Online (without installation) for your labeling specifications.

General ordering data

Type	DEK 5/5 S MC NE WS	Version	
Order No.	1341620000		Dekafix, Terminal marker, 5 x 5 mm, Pitch in mm (P): 5.00
GTIN (EAN)	4050118145793		Weidmueller, white
Qty.	400 ST		

Custom printing



The Dekafix (DEK) marker is the universal marker for all conductor and plug-in connectors as well as for electronic sub-assemblies. The system is ideal for short number sequences and covers a wide range of ready-printed markers.

Strips for fast installation in only one work step. The printing is easy to read, rich in contrast and available in various widths.

- Large range of ready-to-use markers
 - Strips for fast installation
 - Terminal markers, suitable for all Weidmüller cable connectors
 - Available as blank MultiCard or with standard printing
- For custom printing: Please send us a file of our labeling software M-Print PRO or M-Print PRO Online (without installation) for your labeling specifications.

General ordering data

Type	DEK 5/5 S MC SDR	Version	
Order No.	1341590000		Dekafix, Terminal marker, 5 x 5 mm, Pitch in mm (P): 5.00
GTIN (EAN)	4050118146042		Weidmueller, To customer specification
Qty.	80 ST		
Type	WS 10/5 M PLUS MC SDR	Version	
Order No.	2007770000		WS, Terminal marker, 10 x 5 mm, Pitch in mm (P): 5.00 Weidmueller,
GTIN (EAN)	4050118393279		Allen-Bradley, To customer specification
Qty.	120 ST		

S4C 2.5 DL

Weidmüller Interface GmbH & Co. KG
 Klingenbergstraße 26
 D-32758 Detmold
 Germany

www.weidmueller.com

Accessories

Blank



WS markers are the perfect match for the W-series connectors. Thanks to their system compatibility, the WS tags can also be used with the I-series and the Z-series. The large marking surfaces do not only permit long character strings but also multi-line text. WS markers are ideal for labels with long, customised character strings. Thanks to the proven MultiCard format, printing with PrintJet CONNECT oder/or Plotter is possible.

- Can be fitted in strips or individually
- Markers in proven MultiCard format

For custom printing: Please send us a file of our labeling software M-Print PRO or M-Print PRO Online (without installation) for your labeling specifications.

General ordering data

Type	WS 10/5 M PLUS MC NE WS	Version
Order No.	2003770000	WS, Terminal marker, 10 x 5 mm, Pitch in mm (P): 5.00 Weidmueller,
GTIN (EAN)	4050118424447	Allen-Bradley, white
Qty.	600 ST	
Type	WS 10/5 M MC NE WS	Version
Order No.	1792000000	WS, Terminal marker, 10 x 5 mm, Pitch in mm (P): 5.00 Weidmueller,
GTIN (EAN)	4032248223862	Allen-Bradley, white
Qty.	720 ST	

Custom printing



WS markers are the perfect match for the W-series connectors. Thanks to their system compatibility, the WS tags can also be used with the I-series and the Z-series. The large marking surfaces do not only permit long character strings but also multi-line text. WS markers are ideal for labels with long, customised character strings. Thanks to the proven MultiCard format, printing with PrintJet CONNECT oder/or Plotter is possible.

- Can be fitted in strips or individually
- Markers in proven MultiCard format

For custom printing: Please send us a file of our labeling software M-Print PRO or M-Print PRO Online (without installation) for your labeling specifications.

General ordering data

Type	WS 10/5 MC M SDR	Version
Order No.	1792010000	WS, Terminal marker, 10 x 5 mm, Pitch in mm (P): 5.00 Weidmueller,
GTIN (EAN)	4032248223879	Allen-Bradley, To customer specification
Qty.	144 ST	

S4C 2.5 DL

Weidmüller Interface GmbH & Co. KG

Klingenbergstraße 26

D-32758 Detmold

Germany

www.weidmueller.com

Accessories

Blank



WS markers are the perfect match for the W-series connectors. Thanks to their system compatibility, the WS tags can also be used with the I-series and the Z-series. The large marking surfaces do not only permit long character strings but also multi-line text. WS markers are ideal for labels with long, customised character strings. Thanks to the proven MultiCard format, printing with PrintJet CONNECT oder/or Plotter is possible.

- Can be fitted in strips or individually
- Markers in proven MultiCard format

For custom printing: Please send us a file of our labeling software M-Print PRO or M-Print PRO Online (without installation) for your labeling specifications.

General ordering data

Type	WS 10/5 MC NE BL	Version
Order No.	1773531693	WS, Terminal marker, 10 x 5 mm, Pitch in mm (P): 5.00 Weidmueller,
GTIN (EAN)	4032248141814	Allen-Bradley, blue
Qty.	720 ST	
Type	WS 10/5 MC NE GE	Version
Order No.	1773531687	WS, Terminal marker, 10 x 5 mm, Pitch in mm (P): 5.00 Weidmueller,
GTIN (EAN)	4032248141753	Allen-Bradley, yellow
Qty.	720 ST	
Type	WS 10/5 MC NE RT	Version
Order No.	1773531686	WS, Terminal marker, 10 x 5 mm, Pitch in mm (P): 5.00 Weidmueller,
GTIN (EAN)	4032248141746	Allen-Bradley, red
Qty.	720 ST	
Type	WS 10/5 MC NE WS	Version
Order No.	1635000000	WS, Terminal marker, 10 x 5 mm, Pitch in mm (P): 5.00 Weidmueller,
GTIN (EAN)	4008190261948	Allen-Bradley, white
Qty.	720 ST	

Custom printing



WS markers are the perfect match for the W-series connectors. Thanks to their system compatibility, the WS tags can also be used with the I-series and the Z-series. The large marking surfaces do not only permit long character strings but also multi-line text. WS markers are ideal for labels with long, customised character strings. Thanks to the proven MultiCard format, printing with PrintJet CONNECT oder/or Plotter is possible.

- Can be fitted in strips or individually
- Markers in proven MultiCard format

For custom printing: Please send us a file of our labeling software M-Print PRO or M-Print PRO Online (without installation) for your labeling specifications.

S4C 2.5 DL

Weidmüller Interface GmbH & Co. KG

Klingenbergstraße 26

D-32758 Detmold

Germany

www.weidmueller.com

Accessories

General ordering data

Type	WS 10/5 MC SDR	Version
Order No.	1635010000	WS, Terminal marker, 10 x 5 mm, Pitch in mm (P): 5.00 Weidmueller,
GTIN (EAN)	4008190456634	Allen-Bradley, To customer specification
Qty.	144 ST	

Blank



WS markers are the perfect match for the W-series connectors. Thanks to their system compatibility, the WS tags can also be used with the I-series and the Z-series. The large marking surfaces do not only permit long character strings but also multi-line text. WS markers are ideal for labels with long, customised character strings. Thanks to the proven MultiCard format, printing with PrintJet CONNECT oder/or Plotter is possible.

- Can be fitted in strips or individually
- Markers in proven MultiCard format

For custom printing: Please send us a file of our labeling software M-Print PRO or M-Print PRO Online (without installation) for your labeling specifications.

General ordering data

Type	WS 10/5 PLUS MC NE WS	Version
Order No.	1046380000	WS, Terminal marker, 10 x 5 mm, Pitch in mm (P): 5.00 Weidmueller,
GTIN (EAN)	4032248782086	Allen-Bradley, white
Qty.	600 ST	

Custom printing



WS markers are the perfect match for the W-series connectors. Thanks to their system compatibility, the WS tags can also be used with the I-series and the Z-series. The large marking surfaces do not only permit long character strings but also multi-line text. WS markers are ideal for labels with long, customised character strings. Thanks to the proven MultiCard format, printing with PrintJet CONNECT oder/or Plotter is possible.

- Can be fitted in strips or individually
- Markers in proven MultiCard format

For custom printing: Please send us a file of our labeling software M-Print PRO or M-Print PRO Online (without installation) for your labeling specifications.

General ordering data

Type	WS 10/5 PLUS MC SDR	Version
Order No.	1046320000	WS, Terminal marker, 10 x 5 mm, Pitch in mm (P): 5.00 Weidmueller,
GTIN (EAN)	4032248782024	Allen-Bradley, To customer specification
Qty.	120 ST	

S4C 2.5 DL

Weidmüller Interface GmbH & Co. KG

Klingenbergstraße 26

D-32758 Detmold

Germany

Accessories

www.weidmueller.com

DEK 5/5



WS/ DEK

MultiMark terminal markers use an innovative composite material made from two components. The hard base contour of the marker snaps securely into the connector. The elastic surface finish makes the marker easy to mount. This specially punched material enables the strips to be stretched to accommodate the slight variations in spacing that tend to add up, especially with long terminal blocks. Another advantage: the excellent printability of the surface material guarantees durable and wear-resistant labelling. A print resolution of 300 dpi also produces a very legible script.

Your benefits with MultiMark

- Firm hold and durable printing
- Continuous strips save installation time
- Easy mounting thanks to an innovative composite material
- Large label field for optimal legibility
- High flexibility thanks to manufacturer independence

General ordering data

Type	DEK 5/5 MM WS	Version	
Order No.	2007110000	Dekafix, Terminal marker, 5 x 5 mm, Weidmueller, white	
GTIN (EAN)	4050118391862		
Qty.	800 ST		

WS 8/5

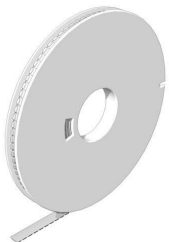

WS/ DEK

MultiMark terminal markers use an innovative composite material made from two components. The hard base contour of the marker snaps securely into the connector. The elastic surface finish makes the marker easy to mount. This specially punched material enables the strips to be stretched to accommodate the slight variations in spacing that tend to add up, especially with long terminal blocks. Another advantage: the excellent printability of the surface material guarantees durable and wear-resistant labelling. A print resolution of 300 dpi also produces a very legible script.

Your benefits with MultiMark

- Firm hold and durable printing
- Continuous strips save installation time
- Easy mounting thanks to an innovative composite material
- Large label field for optimal legibility
- High flexibility thanks to manufacturer independence

General ordering data

Type	WS 8/5 MM WS	Version	
Order No.	2007150000	WS, Terminal marker, 8 x 5 mm, Weidmueller, white	
GTIN (EAN)	4050118392029		
Qty.	800 ST		

S4C 2.5 DL

Weidmüller Interface GmbH & Co. KG

Klingenbergstraße 26

D-32758 Detmold

Germany

www.weidmueller.com

Accessories

Blank

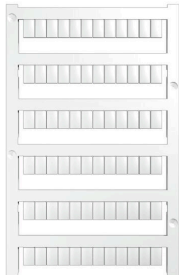

WS markers are the perfect match for the W-series connectors. Thanks to their system compatibility, the WS tags can also be used with the I-series and the Z-series. The large marking surfaces do not only permit long character strings but also multi-line text. WS markers are ideal for labels with long, customised character strings. Thanks to the proven MultiCard format, printing with PrintJet CONNECT oder/or Plotter is possible.

- Can be fitted in strips or individually
- Markers in proven MultiCard format

For custom printing: Please send us a file of our labeling software M-Print PRO or M-Print PRO Online (without installation) for your labeling specifications.

General ordering data

Type	WS 8/5 MC NE BL	Version
Order No.	1773521693	WS, Terminal marker, 8 x 5 mm, Pitch in mm (P): 5.00 Weidmueller,
GTIN (EAN)	4032248141715	Allen-Bradley, blue
Qty.	720 ST	
Type	WS 8/5 MC NE GE	Version
Order No.	1773521687	WS, Terminal marker, 8 x 5 mm, Pitch in mm (P): 5.00 Weidmueller,
GTIN (EAN)	4032248141548	Allen-Bradley, yellow
Qty.	720 ST	
Type	WS 8/5 MC NE OR	Version
Order No.	1773521690	WS, Terminal marker, 8 x 5 mm, Pitch in mm (P): 5.00 Weidmueller,
GTIN (EAN)	4032248143092	Allen-Bradley, orange
Qty.	720 ST	
Type	WS 8/5 MC NE RT	Version
Order No.	1773521686	WS, Terminal marker, 8 x 5 mm, Pitch in mm (P): 5.00 Weidmueller,
GTIN (EAN)	4032248141531	Allen-Bradley, red
Qty.	720 ST	
Type	WS 8/5 MC NE WS	Version
Order No.	1640740000	WS, Terminal marker, 8 x 5 mm, Pitch in mm (P): 5.00 Weidmueller,
GTIN (EAN)	4008190279103	Allen-Bradley, white
Qty.	720 ST	

Custom printing



WS markers are the perfect match for the W-series connectors. Thanks to their system compatibility, the WS tags can also be used with the I-series and the Z-series. The large marking surfaces do not only permit long character strings but also multi-line text. WS markers are ideal for labels with long, customised character strings. Thanks to the proven MultiCard format, printing with PrintJet CONNECT oder/or Plotter is possible.

- Can be fitted in strips or individually
- Markers in proven MultiCard format

For custom printing: Please send us a file of our labeling software M-Print PRO or M-Print PRO Online (without installation) for your labeling specifications.

S4C 2.5 DL

Weidmüller Interface GmbH & Co. KG

Klingenbergstraße 26

D-32758 Detmold

Germany

www.weidmueller.com

Accessories

General ordering data

Type	WS 8/5 MC SDR	Version
Order No.	1640750000	WS, Terminal marker, 8 x 5 mm, Pitch in mm (P): 5.00 Weidmueller,
GTIN (EAN)	4008190456627	Allen-Bradley, To customer specification
Qty.	144 ST	

Blank



WS markers are the perfect match for the W-series connectors. Thanks to their system compatibility, the WS tags can also be used with the I-series and the Z-series. The large marking surfaces do not only permit long character strings but also multi-line text. WS markers are ideal for labels with long, customised character strings. Thanks to the proven MultiCard format, printing with PrintJet CONNECT oder/or Plotter is possible.

- Can be fitted in strips or individually
- Markers in proven MultiCard format

For custom printing: Please send us a file of our labeling software M-Print PRO or M-Print PRO Online (without installation) for your labeling specifications.

General ordering data

Type	WS 8/5 PLUS MC NE WS	Version
Order No.	1951870000	WS, Terminal marker, 8 x 5 mm, Pitch in mm (P): 5.00 Weidmueller,
GTIN (EAN)	4032248631605	Allen-Bradley, white
Qty.	600 ST	

Custom printing

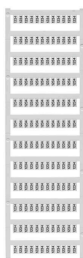

WS markers are the perfect match for the W-series connectors. Thanks to their system compatibility, the WS tags can also be used with the I-series and the Z-series. The large marking surfaces do not only permit long character strings but also multi-line text. WS markers are ideal for labels with long, customised character strings. Thanks to the proven MultiCard format, printing with PrintJet CONNECT oder/or Plotter is possible.

- Can be fitted in strips or individually
- Markers in proven MultiCard format

For custom printing: Please send us a file of our labeling software M-Print PRO or M-Print PRO Online (without installation) for your labeling specifications.

General ordering data

Type	WS 8/5 PLUS MC SDR	Version
Order No.	1038790000	WS, Terminal marker, 8 x 5 mm, Pitch in mm (P): 5.00 Weidmueller,
GTIN (EAN)	4032248768066	Allen-Bradley, To customer specification
Qty.	120 ST	

S4C 2.5 DL

Weidmüller Interface GmbH & Co. KG
 Klingenbergstraße 26
 D-32758 Detmold
 Germany

www.weidmueller.com

Accessories

Accessories

Accessories for testing and measuring equipment



General ordering data

Type	ZUB MULTIMETER	Version	
Order No.	9205270000	Multimeter	
GTIN (EAN)	4032248723522		
Qty.	1 ST		

End bracket

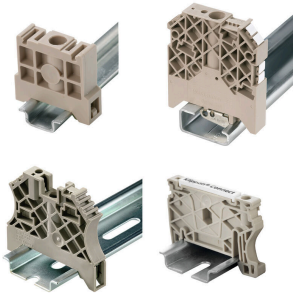

Weidmüller's range of products includes end brackets that guarantee a permanent, reliable mounting on the terminal rail and prevent sliding. Versions with and without screws are available. The end brackets include marking options, also for group markers, and also a test plug holder.

General ordering data

Type	AEB 35 SC/1 BK	Version	
Order No.	2475310000	A-series, End bracket	
GTIN (EAN)	4050118487114		
Qty.	50 ST		

Marker holder



The marker holder offer the possibility of additional mounting of standard markers with a pitch of 5 or 5.1 mm. The angled holders can be optionally snapped together and could be mounted in all standard marking channels of the Klippon® Connect modular terminal blocks. Fitting marker types could be found under the respective accessories of the designation marking holder.

General ordering data

Type	BZT 1 WS 10/5	Version	
Order No.	1805490000	Accessories, Marker holder	
GTIN (EAN)	4032248270231		
Qty.	100 ST		

S4C 2.5 DL

Weidmüller Interface GmbH & Co. KG

Klingenbergstraße 26

D-32758 Detmold

Germany

www.weidmueller.com

Accessories

Type	BZT 1 ZA WS 10/5	Version	
Order No.	1805520000	Accessories, Marker holder	
GTIN (EAN)	4032248270248		
Qty.	100 ST		

End plates and partition plates



Partition plates and end plates are essential accessories for terminal blocks. Partition plates provide optical and electrical separation of different potentials and functional groups, increasing safety and ensuring a clear structure inside the control cabinet. End plates close the terminal block row on the sides, protect against contact with live parts, and ensure a clean, stable finish. Both components are precisely matched to the respective Weidmüller terminal block series, contributing to safe, compliant, and professional wiring.

General ordering data

Type	APP 1	Version	
Order No.	2488970000	A-series, Partition plate	
GTIN (EAN)	4050118499216		
Qty.	50 ST		

End bracket

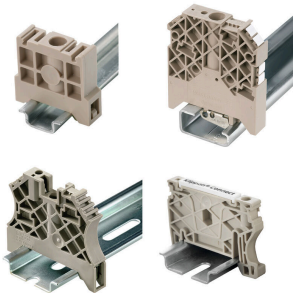

Weidmüller's range of products includes end brackets that guarantee a permanent, reliable mounting on the terminal rail and prevent sliding. Versions with and without screws are available. The end brackets include marking options, also for group markers, and also a test plug holder.

General ordering data

Type	AEB 35 SCL/1 V0	Version	
Order No.	2661280000	A-series, End bracket	
GTIN (EAN)	4050118702163		
Qty.	20 ST		
Type	AEB 35 SCL/1 V0 BK	Version	
Order No.	2661300000	A-series, End bracket	
GTIN (EAN)	4050118702187		
Qty.	20 ST		
Type	AEB 35 SCL/1 V0 GY	Version	
Order No.	2661290000	A-series, End bracket	
GTIN (EAN)	4050118702170		
Qty.	20 ST		
Type	ZST 1	Version	
Order No.	1269070000	Accessories, Accessories holder	
GTIN (EAN)	4050118094091		
Qty.	25 ST		

S4C 2.5 DL

Weidmüller Interface GmbH & Co. KG
 Klingenbergstraße 26
 D-32758 Detmold
 Germany

www.weidmueller.com

Accessories

Type	ZST	Version	
Order No.	1678680000	Z-series, Accessories holder	
GTIN (EAN)	4008190466770		
Qty.	10 ST		

End plates and partition plates



Partition plates and end plates are essential accessories for terminal blocks. Partition plates provide optical and electrical separation of different potentials and functional groups, increasing safety and ensuring a clear structure inside the control cabinet. End plates close the terminal block row on the sides, protect against contact with live parts, and ensure a clean, stable finish. Both components are precisely matched to the respective Weidmüller terminal block series, contributing to safe, compliant, and professional wiring.

General ordering data

Type	SEP 4C 2.5	Version	
Order No.	2751100000	End plate for terminals, dark beige, Height: 82.1 mm, Width: 2.1 mm,	
GTIN (EAN)	4064675267621	V-0, Wemid, Snap-on: Yes	
Qty.	20 ST		

Slotted screwdriver



VDE insulated screwdriver sets, for working on live parts up to 1000 V AC and 1500 V DC, DIN EN 60900. IEC 900. Each piece is "GS" safety tested. Blade made from fully hardened, high-alloy chromium-vanadium-molybdenum steel, gun-metal finish.

General ordering data

Type	SDIS SLIM 0.6X3.5X100	Version	
Order No.	2749610000	Mounting tool, Blade width (B): 3.5 mm, Blade length: 100 mm, Blade	
GTIN (EAN)	4050118896350	thickness (A): 0.6 mm	
Qty.	1 ST		

S4C 2.5 DL

Weidmüller Interface GmbH & Co. KG
Klingenbergstraße 26
D-32758 Detmold
Germany

www.weidmueller.com

Accessories

Testadapter and testsockets



Test adapters and test plugs are used for the electrical connection between terminal blocks and the test equipment. In this way, an electrical contact can be established in the wired state and measurements can be done easily.

General ordering data

Type	FZS 2/4 RT/80 SAKT4	Version	
Order No.	1276300000	Plug (terminal), Plug-in connection, 2 mm ² , Number of connections: 2,	
GTIN (EAN)	4008190026080	Number of poles: 1, Width: 9 mm	
Qty.	20 ST		