

SUZ 10.16HP/06/180DF AG BK BX

Weidmüller Interface GmbH & Co. KG
 Klingenbergstraße 26
 D-32758 Detmold
 Germany

www.weidmueller.com

Product image

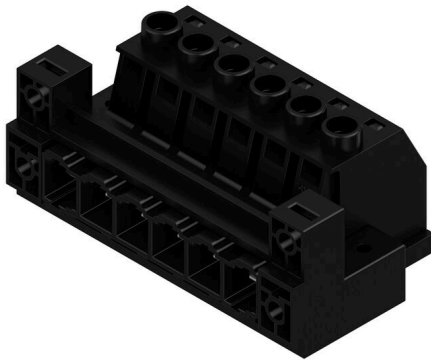

OMNIMATE Power BU / SU 10.16HP - the 50 kVA power class

More current for higher performance.

Top of the class in today's connector systems – the OMNIMATE Power SU / BUZ 10.16HP. They feature a very durable contact system which makes it a pluggable power transmission solution with maximum load reserves. HP stands for High Performance – performance exemplified by a long-term usage temperature of 120°C. This custom, pluggable solution is suitable for all applications that must meet 600 V UL or 1,000 V (IEC) with up to 76 A (IEC) and 54 A (UL).

General ordering data

Version	PCB plug-in connector, male plug, 10.16 mm, Number of poles: 6, 180°, Clamping yoke connection, Clamping range, max. : 16 mm², Box
Order No.	2838130000
Type	SUZ 10.16HP/06/180DF AG BK BX
GTIN (EAN)	4064675436997
Qty.	20 items
Product data	IEC: 1000 V / 78 A / 0.2 - 16 mm² UL: 600 V / 57 A / AWG 24 - AWG 6
Packaging	Box

SUZ 10.16HP/06/180DF AG BK BX

Weidmüller Interface GmbH & Co. KG
Klingenbergstraße 26
D-32758 Detmold
Germany

www.weidmueller.com

Technical data

Approvals

ROHS	Conform
------	---------

Dimensions and weights

Depth	50.5 mm	Depth (inches)	1.9882 inch
Height	36.8 mm	Height (inches)	1.4488 inch
Width	81.28 mm	Width (inches)	3.2 inch
Net weight	91.49 g		

Environmental Product Compliance

RoHS Compliance Status	Compliant without exemption
REACH SVHC	No SVHC above 0.1 wt%

System Parameters

Product family	OMNIMATE Power - series BU/SU 10.16HP	Type of connection	Field connection
Wire connection method	Clamping yoke connection	Pitch in mm (P)	10.16 mm
Pitch in inches (P)	0.400 "	Conductor outlet direction	180°
Number of poles	6	L1 in mm	50.80 mm
L1 in inches	2.000 "	Number of rows	1
Pin series quantity	1	Touch-safe protection acc. to DIN VDE 57 106	Safe from finger touch
Touch-safe protection acc. to DIN VDE 0470	IP 20	Volume resistance	4.50 mΩ
Can be coded	Yes	Stripping length	12 mm
Tightening torque, min.	1.2 Nm	Tightening torque, max.	1.5 Nm
Clamping screw	M 4	Screwdriver blade	1.0 x 5.5
Screwdriver blade standard	DIN 5264	Plugging cycles	25

Material data

Insulating material	PA GF	Colour	black
Colour chart (similar)	RAL 9011	Insulating material group	I
Comparative Tracking Index (CTI)	≥ 600	Moisture Level (MSL)	
UL 94 flammability rating	V-0	Contact material	Cu-alloy
Contact surface	silver-plated	Layer structure of plug contact	≥ 3 μm Ag
Storage temperature, min.	-40 °C	Storage temperature, max.	70 °C
Operating temperature, min.	-50 °C	Operating temperature, max.	130 °C

Conductors suitable for connection

Clamping range, min.	0.2 mm ²
Clamping range, max.	16 mm ²
Wire connection cross section AWG, min.	AWG 22
Wire connection cross section AWG, max.	AWG 6
Solid, min. H05(07) V-U	0.2 mm ²
Solid, max. H05(07) V-U	16 mm ²
Stranded, min. H07V-R	6 mm ²
Stranded, max. H07V-R	16 mm ²
Flexible, min. H05(07) V-K	0.5 mm ²
Flexible, max. H05(07) V-K	16 mm ²

SUZ 10.16HP/06/180DF AG BK BX

Weidmüller Interface GmbH & Co. KG
 Klingenbergstraße 26
 D-32758 Detmold
 Germany

www.weidmueller.com

Technical data

w. plastic collar ferrule, DIN 46228 pt 4, 0.25 mm²
 min.

w. plastic collar ferrule, DIN 46228 pt 4, 10 mm²
 max.

w. wire end ferrule, DIN 46228 pt 1, 0.25 mm²
 min.

w. wire end ferrule, DIN 46228 pt 1, 16 mm²
 max.

Plug gauge in accordance with EN 60999 a x b; ø 5.3mm (B6)

Clampable conductor	Cross-section for conductor connection	Type	fine-wired
		nominal	0.5 mm ²
wire end ferrule	Stripping length	nominal	14 mm
	Recommended wire-end ferrule		H0.5/18 OR
Clampable conductor	Cross-section for conductor connection	Type	fine-wired
		nominal	1 mm ²
wire end ferrule	Stripping length	nominal	15 mm
	Recommended wire-end ferrule		H1.0/18 GE
Clampable conductor	Cross-section for conductor connection	Type	fine-wired
		nominal	1.5 mm ²
wire end ferrule	Stripping length	nominal	15 mm
	Recommended wire-end ferrule		H1.5/18D SW
	Stripping length	nominal	12 mm
	Recommended wire-end ferrule		H1.5/12
Clampable conductor	Cross-section for conductor connection	Type	fine-wired
		nominal	0.75 mm ²
wire end ferrule	Stripping length	nominal	14 mm
	Recommended wire-end ferrule		H0.75/18 W
Clampable conductor	Cross-section for conductor connection	Type	fine-wired
		nominal	2.5 mm ²
wire end ferrule	Stripping length	nominal	14 mm
	Recommended wire-end ferrule		H2.5/19D BL
	Stripping length	nominal	12 mm
	Recommended wire-end ferrule		H2.5/12
Clampable conductor	Cross-section for conductor connection	Type	fine-wired
		nominal	4 mm ²
wire end ferrule	Stripping length	nominal	12 mm
	Recommended wire-end ferrule		H4.0/12
	Stripping length	nominal	14 mm
	Recommended wire-end ferrule		H4.0/20D GR
Clampable conductor	Cross-section for conductor connection	Type	fine-wired
		nominal	6 mm ²
wire end ferrule	Stripping length	nominal	14 mm
	Recommended wire-end ferrule		H6.0/20 SW
	Stripping length	nominal	12 mm
	Recommended wire-end ferrule		H6.0/12
Clampable conductor	Cross-section for conductor connection	Type	fine-wired
		nominal	10 mm ²
wire end ferrule	Stripping length	nominal	12 mm

SUZ 10.16HP/06/180DF AG BK BX

Weidmüller Interface GmbH & Co. KG
 Klingenbergstraße 26
 D-32758 Detmold
 Germany

www.weidmueller.com

Technical data

		Recommended wire-end ferrule	H10.0/12
		Stripping length	nominal 15 mm
		Recommended wire-end ferrule	H10.0/22 EB
	Cross-section for conductor connection	Type	fine-wired
		nominal	16 mm ²
	wire end ferrule	Stripping length	nominal 12 mm
		Recommended wire-end ferrule	H16.0/12
Reference text	Length of ferrules is to be chosen depending on the product and the rated voltage.		

Rated data acc. to IEC

tested acc. to standard	IEC 60664-1, IEC 61984	Rated current, min. number of poles (Tu=20°C)	78 A
Rated current, max. number of poles (Tu=20°C)	68 A	Rated current, min. number of poles (Tu=40°C)	72 A
Rated current, max. number of poles (Tu=40°C)	61 A	Rated voltage for surge voltage class / pollution degree II/2	1000 V
Rated voltage for surge voltage class / pollution degree III/2	1000 V	Rated voltage for surge voltage class / pollution degree III/3	1000 V
Rated impulse voltage for surge voltage class/ pollution degree II/2	6 kV	Rated impulse voltage for surge voltage class/ pollution degree III/2	8 kV
Rated impulse voltage for surge voltage class/ contamination degree III/3	8 kV	Short-time withstand current resistance	3 x 1s with 800A
Creepage distance, min.	14.8 mm	Clearance, min.	14.8 mm

Rated data acc. to CSA

Rated voltage (Use group B / CSA)	600 V	Rated voltage (Use group C / CSA)	600 V
Rated voltage (Use group D / CSA)	600 V	Rated current (Use group B / CSA)	57 A
Rated current (Use group C / CSA)	57 A	Rated current (Use group D / CSA)	5 A
Wire cross-section, AWG, min.	AWG 24	Wire cross-section, AWG, max.	AWG 6

Rated data acc. to UL 1059

Rated voltage (Use group B / UL 1059)	600 V	Rated voltage (Use group C / UL 1059)	600 V
Rated voltage (Use group D / UL 1059)	600 V	Rated current (Use group B / UL 1059)	57 A
Rated current (Use group C / UL 1059)	57 A	Rated current (Use group D / UL 1059)	5 A
Wire cross-section, AWG, min.	AWG 24	Wire cross-section, AWG, max.	AWG 6

Packing

Packaging	Box	VPE length	338.00 mm
VPE width	130.00 mm	VPE height	54.00 mm

Type tests

Test: Durability of markings	Standard	taking pattern from DIN EN 60068-2-70 / 07.96
	Test	date clock, mark of origin, type identification, type of material
	Evaluation	available
	Test	durability
Test: Misengagement (Non-interchangeability)	Evaluation	passed
	Standard	DIN EN 61984 section 6.3 and 6.9.1 / 09.02, DIN IEC 60512 part 7 section 5 / 05.94
	Test	180° turned with coding elements
	Evaluation	passed

SUZ 10.16HP/06/180DF AG BK BX

Weidmüller Interface GmbH & Co. KG
 Klingenbergstraße 26
 D-32758 Detmold
 Germany

www.weidmueller.com

Technical data

	Test	180° turned without coding elements	
	Evaluation	passed	
Test: Clampable cross section	Standard	DIN EN 60999-1 section 7 and 9.1 / 12.00, DIN EN 60947-1 section 8.2.4.5.1 / 12.02	
	Conductor type	Type of conductor and conductor cross-section	solid 0.2 mm ²
		Type of conductor and conductor cross-section	stranded 0.2 mm ²
		Type of conductor and conductor cross-section	solid 16 mm ²
		Type of conductor and conductor cross-section	stranded 16 mm ²
		Type of conductor and conductor cross-section	AWG 24/1
		Type of conductor and conductor cross-section	AWG 24/19
		Type of conductor and conductor cross-section	AWG 6/1
		Type of conductor and conductor cross-section	AWG 6/19
Evaluation	passed		
Test for damage to and accidental loosening of conductors	Standard	DIN EN 60999-1 section 9.4 / 12.00	
	Requirement	0.2 kg	
	Conductor type	Type of conductor and conductor cross-section	AWG 24/1
		Type of conductor and conductor cross-section	AWG 24/19
	Evaluation	passed	
	Requirement	0.3 kg	
	Conductor type	Type of conductor and conductor cross-section	solid 0.5 mm ²
		Type of conductor and conductor cross-section	stranded 0.5 mm ²
	Evaluation	passed	
	Requirement	2.9 kg	
Conductor type	Type of conductor and conductor cross-section	solid 16 mm ²	
	Type of conductor and conductor cross-section	stranded 16 mm ²	
Evaluation	passed		
Requirement	0,9 kg		
Conductor type	Type of conductor and conductor cross-section	AWG 6/7	
	Type of conductor and conductor cross-section	AWG 6/19	
Evaluation	passed		
Pull-out test	Standard	DIN EN 60999-1 section 9.5 / 12.00	

SUZ 10.16HP/06/180DF AG BK BX

Weidmüller Interface GmbH & Co. KG
 Klingenbergstraße 26
 D-32758 Detmold
 Germany

www.weidmueller.com

Technical data

Requirement	≥10 N	
Conductor type	Type of conductor and conductor cross-section	AWG 24/1
	Type of conductor and conductor cross-section	AWG 24/19
Evaluation	passed	
Requirement	≥20 N	
Conductor type	Type of conductor and conductor cross-section	solid 0.5 mm ²
	Type of conductor and conductor cross-section	stranded 0.5 mm ²
Evaluation	passed	
Requirement	≥100 N	
Conductor type	Type of conductor and conductor cross-section	solid 16 mm ²
	Type of conductor and conductor cross-section	stranded 16 mm ²
	Type of conductor and conductor cross-section	AWG 6/7
	Type of conductor and conductor cross-section	AWG 6/19
Evaluation	passed	

Important note

IPC conformity Conformity: The products are developed, manufactured and delivered according international recognized standards and norms and comply with the assured properties in the data sheet resp. fulfill decorative properties in accordance with IPC-A-610 "Class 2". Further claims on the products can be evaluated on request.

- Notes**
- Additional variants on request
 - Rated current related to rated cross-section & min. No. of poles.
 - Wire end ferrule without plastic collar to DIN 46228/1
 - Wire end ferrule with plastic collar to DIN 46228/4
 - P on drawing = pitch
 - Rated data refer only to the component itself. Clearance and creepage distances to other components are to be designed in accordance with the relevant application standards.
 - In accordance with IEC 61984, OMNIMATE-connectors are connectors without breaking capacity (COC). During designated use, connectors are not allowed to be engaged or disengaged when live or under load
 - Long term storage of the product with average temperature of 50 °C and maximum humidity 70%, 36 months

Classifications

ETIM 8.0	EC002638	ETIM 9.0	EC002638
ETIM 10.0	EC002638	ECLASS 14.0	27-46-02-02
ECLASS 15.0	27-46-02-02		

SUZ 10.16HP/06/180DF AG BK BX

Weidmüller Interface GmbH & Co. KG
 Klingenbergstraße 26
 D-32758 Detmold
 Germany

Drawings

www.weidmueller.com

Product image

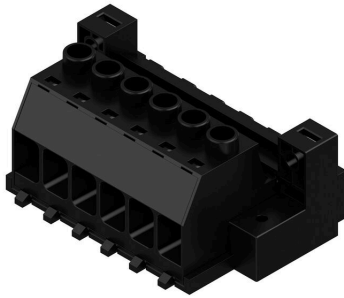

Dimensional drawing

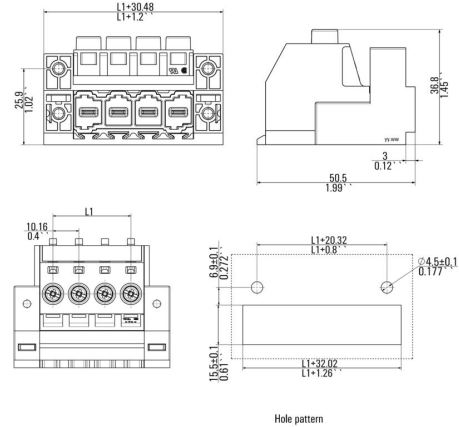

Graph

