

SUZ DF 10.16/02/180SF BK BX

Weidmüller Interface GmbH & Co. KG
 Klingenbergstraße 26
 D-32758 Detmold
 Germany

www.weidmueller.com

Product image

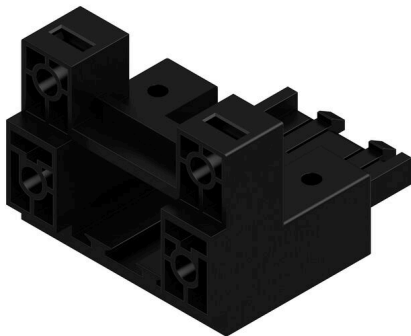

The pluggable connections for power electronics - optimised for modern drive technologies, e.g. motor starters, frequency converters and servo-controllers.

OMNIMATE Power sets the new standard – with increased safety and innovative solutions such as the pluggable shield, integrated signal contacts and one-handed operation.

The three product lines offer you further advantages:

- Application-oriented scalability: from the compact 4 mm² connector for 29 A (IEC) or 20 A (UL) up to the sturdy 16 mm² connector for 76 A (IEC) or 54 A (UL)
- Unlimited usage up to 1,000 V (IEC) or 600 V (UL)
- A variety of application optimised mounting options

Our service:

Design your individual connectors simply by using the product configurator.

General ordering data

Version	PCB plug-in connector, Accessories, Mounting block, black, Number of poles: 2
Order No.	283801000
Type	SUZ DF 10.16/02/180SF BK BX
GTIN (EAN)	4064675436836
Qty.	40 items
Product data	
Packaging	Box

SUZ DF 10.16/02/180SF BK BX

Weidmüller Interface GmbH & Co. KG
 Klingenbergstraße 26
 D-32758 Detmold
 Germany

www.weidmueller.com

Technical data

Approvals

ROHS	Conform
------	---------

Dimensions and weights

Depth	50.5 mm	Depth (inches)	1.9882 inch
Height	31 mm	Height (inches)	1.2205 inch
Width	40.64 mm	Width (inches)	1.6 inch
Net weight	13.49 g		

Environmental Product Compliance

RoHS Compliance Status	Compliant without exemption
REACH SVHC	No SVHC above 0.1 wt%

Material data

Insulating material	PA 66/6	Colour	black
Colour chart (similar)	RAL 9011	Moisture Level (MSL)	
UL 94 flammability rating	V-0	Storage temperature, min.	-40 °C
Storage temperature, max.	70 °C	Operating temperature, min.	-50 °C
Operating temperature, max.	100 °C		

Rated data acc. to IEC

tested acc. to standard	IEC 60664-1, IEC 61984
-------------------------	------------------------

Packing

Packaging	Box	VPE length	399.00 mm
VPE width	219.00 mm	VPE height	61.00 mm

Important note

IPC conformity	Conformity: The products are developed, manufactured and delivered according international recognized standards and norms and comply with the assured properties in the data sheet resp. fulfill decorative properties in accordance with IPC-A-610 "Class 2". Further claims on the products can be evaluated on request.
----------------	--

Notes	<ul style="list-style-type: none"> Long term storage of the product with average temperature of 50 °C and maximum humidity 70%, 36 months
-------	--

Classifications

ETIM 8.0	EC002943	ETIM 9.0	EC002943
ETIM 10.0	EC002943	ECLASS 14.0	27-46-04-05
ECLASS 15.0	27-46-04-05		

Product image

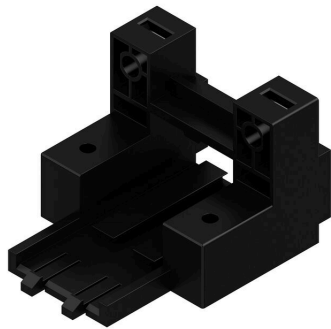

Dimensional drawing

