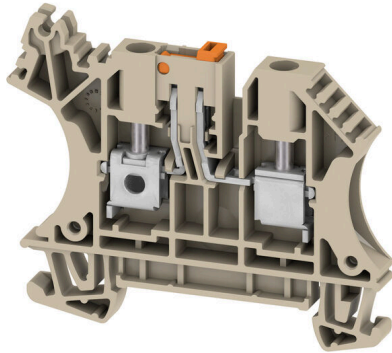

**WFS 4 DI****Weidmüller Interface GmbH & Co. KG**

Klingenbergstraße 26

D-32758 Detmold

Germany

[www.weidmueller.com](http://www.weidmueller.com)

In some applications it makes sense to add a test point or a disconnect element to the feed through terminal for testing and safety purposes. With test disconnect terminals you measure electric circuits in the absence of voltage. While the disconnecting points clearance and creepage distance is not assessed in dimensional terms, the specified rated impulse voltage strength must be proven.

**General ordering data**

Version	Test-disconnect terminal, Screw connection, dark beige, 4 mm <sup>2</sup> , 32 A, 400 V, Number of connections: 2, Number of levels: 1
Order No.	<a href="#">2796780000</a>
Type	WFS 4 DI
GTIN (EAN)	4064675211907
Qty.	50 items

## WFS 4 DI

Weidmüller Interface GmbH &amp; Co. KG

Klingenbergstraße 26

D-32758 Detmold

Germany

www.weidmueller.com

## Technical data

## Approvals

ROHS Conform

## Dimensions and weights

Depth	50.5 mm	Depth (inches)	1.9882 inch
Height	62.5 mm	Height (inches)	2.4606 inch
Width	6.1 mm	Width (inches)	0.2402 inch
Net weight	11.7 g		

## Temperatures

Storage temperature	-25 °C...55 °C	Ambient temperature	-60 °C...85 °C
Continuous operating temp., min.	-60 °C	Continuous operating temp., max.	130 °C

## Environmental Product Compliance

RoHS Compliance Status	Compliant without exemption
REACH SVHC	No SVHC above 0.1 wt%

## Material data

Basic material	Wemid	Colour	dark beige
Colour of operational elements	orange	UL 94 flammability rating	V-0

## System specifications

End cover plate required	Yes	Number of potentials	1
Number of levels	1	Number of clamping points per level	2
Levels cross-connected internally	No	Mounting rail	TS 35

## Additional technical data

Snap-on	Yes	Type of mounting	TS 35
---------	-----	------------------	-------

## Conductors for clamping (additional connection)

Connection type, additional connection Screw connection

## Conductors for clamping (rated connection)

Wire connection cross section AWG, max.	AWG 10	Connection direction	on side
Tightening torque, max.	0.6 Nm	Tightening torque, min.	0.5 Nm
Stripping length	13 mm	Type of connection 2	Screw connection
Type of connection	Screw connection	Number of connections	2
Clamping range, max.	6 mm <sup>2</sup>	Clamping range, min.	0.22 mm <sup>2</sup>
Blade size	0.6 x 3.5 mm	Wire connection cross section AWG, min.	AWG 22
Wire connection cross-section, finely stranded with wire-end ferrules DIN 46228/4, max.	4 mm <sup>2</sup>	Wire connection cross-section, finely stranded with wire-end ferrules DIN 46228/4, min.	0.22 mm <sup>2</sup>
Wire connection cross-section, finely stranded with wire-end ferrules DIN 46228/1, max.	4 mm <sup>2</sup>	Wire connection cross-section, finely stranded with wire-end ferrules DIN 46228/1, min.	0.22 mm <sup>2</sup>

## WFS 4 DI

**Weidmüller Interface GmbH & Co. KG**

Klingenbergstraße 26  
D-32758 Detmold  
Germany

[www.weidmueller.com](http://www.weidmueller.com)

## Technical data

Wire connection cross section, finely stranded, max.	6 mm <sup>2</sup>	Wire connection cross section, finely stranded, min.	0.22 mm <sup>2</sup>
Connection cross-section, stranded, max.	6 mm <sup>2</sup>	Connection cross-section, stranded, min.	0.22 mm <sup>2</sup>
Wire connection cross-section, solid core, max.	6 mm <sup>2</sup>	Wire connection cross-section, solid core, min.	0.22 mm <sup>2</sup>
Connection cross-section, finely stranded, min.	0.22 mm <sup>2</sup>		

### General

Wire connection cross section AWG, max.	AWG 10	Wire connection cross section AWG, min.	AWG 22
Mounting rail	TS 35		

### Rating data

Rated cross-section	4 mm <sup>2</sup>	Rated voltage	400 V
Rated DC voltage	400 V	Nominal current	32 A
Current at maximum wires	32 A	Rated impulse withstand voltage	6 kV
Power loss in accordance with IEC 60947-7-x	1.02 W	Surge voltage category	III
Pollution severity	3		

### Classifications

ETIM 8.0	EC000902	ETIM 9.0	EC000902
ETIM 10.0	EC000902	ECLASS 14.0	27-25-01-09
ECLASS 15.0	27-25-01-09		

Drawings

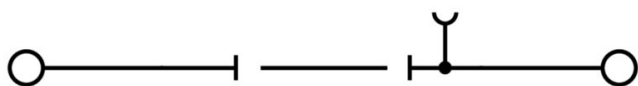

## Accessories

### End plates and partition plates



Partition plates and end plates are essential accessories for terminal blocks. Partition plates provide optical and electrical separation of different potentials and functional groups, increasing safety and ensuring a clear structure inside the control cabinet. End plates close the terminal block row on the sides, protect against contact with live parts, and ensure a clean, stable finish. Both components are precisely matched to the respective Weidmüller terminal block series, contributing to safe, compliant, and professional wiring.

### General ordering data

Type	WAP 2.5-10	Version
Order No.	<a href="#">105000000</a>	End plate for terminals, dark beige, Height: 56 mm, Width: 1.5 mm,
GTIN (EAN)	4008190103149	V-0, Wemid, Snap-on: No
Qty.	50 ST	
Type	WAP 2.5-10 BL	Version
Order No.	<a href="#">105008000</a>	End plate for terminals, blue, Height: 56 mm, Width: 1.5 mm, V-0,
GTIN (EAN)	4008190136611	Wemid, Snap-on: No
Qty.	50 ST	
Type	WAP 2.5-10 BR	Version
Order No.	<a href="#">105007000</a>	End plate for terminals, brown, Height: 56 mm, Width: 1.5 mm, V-0,
GTIN (EAN)	4008190455507	Wemid, Snap-on: No
Qty.	50 ST	
Type	WAP 2.5-10 GE	Version
Order No.	<a href="#">105002000</a>	End plate for terminals, yellow, Height: 56 mm, Width: 1.5 mm, V-0,
GTIN (EAN)	4008190406776	Wemid, Snap-on: No
Qty.	50 ST	
Type	WAP 2.5-10 GN	Version
Order No.	<a href="#">107220000</a>	End plate for terminals, green, Height: 56 mm, Width: 1.5 mm, V-0,
GTIN (EAN)	4008190455491	Wemid, Snap-on: No
Qty.	50 ST	
Type	WAP 2.5-10 GR	Version
Order No.	<a href="#">105005000</a>	End plate for terminals, grey, Height: 56 mm, Width: 1.5 mm, V-0,
GTIN (EAN)	4008190455484	Wemid, Snap-on: No
Qty.	50 ST	
Type	WAP 2.5-10 OR	Version
Order No.	<a href="#">105006000</a>	End plate for terminals, orange, Height: 56 mm, Width: 1.5 mm, V-0,
GTIN (EAN)	4008190406769	Wemid, Snap-on: No
Qty.	50 ST	
Type	WAP 2.5-10 RT	Version
Order No.	<a href="#">105004000</a>	End plate for terminals, red, Height: 56 mm, Width: 1.5 mm, V-0,
GTIN (EAN)	4008190406783	Wemid, Snap-on: No
Qty.	50 ST	
Type	WAP 2.5-10 SW	Version
Order No.	<a href="#">105001000</a>	End plate for terminals, black, Height: 56 mm, Width: 1.5 mm, V-0,
GTIN (EAN)	4008190406806	Wemid, Snap-on: No
Qty.	50 ST	
Type	WAP 2.5-10 VI	Version
Order No.	<a href="#">107221000</a>	End plate for terminals, violet, Height: 56 mm, Width: 1.5 mm, V-0,
GTIN (EAN)	4008190455460	Wemid, Snap-on: No
Qty.	50 ST	

## WFS 4 DI

Weidmüller Interface GmbH &amp; Co. KG

 Klingenbergstraße 26  
 D-32758 Detmold  
 Germany

www.weidmueller.com

## Accessories

Type	WAP 2.5-10 WS	Version
Order No.	<a href="#">1050090000</a>	End plate for terminals, white, Height: 56 mm, Width: 1.5 mm, V-0,
GTIN (EAN)	4008190406790	Wemid, Snap-on: No
Qty.	50 ST	

## Cross-connections



The distribution or multiplication of a potential to adjoining terminal blocks is realized via a cross-connection. Additional wiring effort can be easily avoided. Even if the poles are broken out, contact reliability in the terminal blocks is still ensured. Our portfolio offers pluggable and screwable cross-connection systems for modular terminal blocks.

## General ordering data

Type	ZQV 4N/10 RD	Version
Order No.	<a href="#">2460740000</a>	Cross-connector (terminal), Plugged, red, 32 A, Number of poles: 10,
GTIN (EAN)	4050118476163	Pitch in mm (P): 6.10, Insulated: Yes, Width: 58.7 mm
Qty.	20 ST	
Type	ZQV 4N/2	Version
Order No.	<a href="#">1527930000</a>	Cross-connector (terminal), Plugged, orange, 32 A, Number of poles: 2,
GTIN (EAN)	4050118332766	Pitch in mm (P): 6.10, Insulated: Yes, Width: 9.9 mm
Qty.	60 ST	
Type	ZQV 4N/2 BL	Version
Order No.	<a href="#">1528040000</a>	Cross-connector (terminal), Plugged, blue, 32 A, Number of poles: 2,
GTIN (EAN)	4050118332773	Pitch in mm (P): 6.10, Insulated: Yes, Width: 9.9 mm
Qty.	60 ST	
Type	ZQV 4N/2 RD	Version
Order No.	<a href="#">2460450000</a>	Cross-connector (terminal), Plugged, red, 32 A, Number of poles: 2,
GTIN (EAN)	4050118476149	Pitch in mm (P): 6.10, Insulated: Yes, Width: 9.9 mm
Qty.	60 ST	
Type	ZQV 4N/3	Version
Order No.	<a href="#">1527940000</a>	Cross-connector (terminal), Plugged, orange, 32 A, Number of poles: 3,
GTIN (EAN)	4050118332865	Pitch in mm (P): 6.10, Insulated: Yes, Width: 16 mm
Qty.	60 ST	
Type	ZQV 4N/3 BL	Version
Order No.	<a href="#">1528080000</a>	Cross-connector (terminal), Plugged, blue, 32 A, Number of poles: 3,
GTIN (EAN)	4050118333008	Pitch in mm (P): 6.10, Insulated: Yes, Width: 16 mm
Qty.	60 ST	
Type	ZQV 4N/10	Version
Order No.	<a href="#">1528090000</a>	Cross-connector (terminal), Plugged, orange, 32 A, Number of poles: 10,
GTIN (EAN)	4050118332896	Pitch in mm (P): 6.10, Insulated: Yes, Width: 58.7 mm
Qty.	20 ST	
Type	ZQV 4N/10 BL	Version
Order No.	<a href="#">1528230000</a>	Cross-connector (terminal), Plugged, blue, 32 A, Number of poles: 10,
GTIN (EAN)	4050118333138	Pitch in mm (P): 6.10, Insulated: Yes, Width: 58.7 mm
Qty.	20 ST	

## WFS 4 DI

**Weidmüller Interface GmbH & Co. KG**

Klingenbergstraße 26  
D-32758 Detmold  
Germany

www.weidmueller.com

## Accessories

Type	ZQV 4N/3 RD	Version
Order No.	<a href="#">2460810000</a>	Cross-connector (terminal), Plugged, red, 32 A, Number of poles: 3,
GTIN (EAN)	4050118476231	Pitch in mm (P): 6.10, Insulated: Yes, Width: 16 mm
Qty.	60 ST	
Type	ZQV 4N/30	Version
Order No.	<a href="#">2561580000</a>	Cross-connector (terminal), Plugged, orange, 32 A, Number of poles:
GTIN (EAN)	4050118570113	30, Pitch in mm (P): 6.10, Insulated: Yes, Width: 181.7 mm
Qty.	5 ST	
Type	ZQV 4N/30 BL	Version
Order No.	<a href="#">2561610000</a>	Cross-connector (terminal), Plugged, blue, 32 A, Number of poles: 30,
GTIN (EAN)	4050118569971	Pitch in mm (P): 6.10, Insulated: Yes, Width: 181.7 mm
Qty.	5 ST	
Type	ZQV 4N/30 RD	Version
Order No.	<a href="#">2561600000</a>	Cross-connector (terminal), Plugged, red, 32 A, Number of poles: 30,
GTIN (EAN)	4050118569964	Pitch in mm (P): 6.10, Insulated: Yes, Width: 181.7 mm
Qty.	5 ST	
Type	ZQV 4N/32	Version
Order No.	<a href="#">2561670000</a>	Cross-connector (terminal), Plugged, orange, 32 A, Number of poles:
GTIN (EAN)	4050118570175	32, Pitch in mm (P): 6.10, Insulated: Yes, Width: 193.9 mm
Qty.	5 ST	
Type	ZQV 4N/4	Version
Order No.	<a href="#">1527970000</a>	Cross-connector (terminal), Plugged, orange, 32 A, Number of poles:
GTIN (EAN)	4050118332889	4, Pitch in mm (P): 6.10, Insulated: Yes, Width: 22.1 mm
Qty.	60 ST	
Type	ZQV 4N/4 BL	Version
Order No.	<a href="#">1528120000</a>	Cross-connector (terminal), Plugged, blue, 32 A, Number of poles: 4,
GTIN (EAN)	4050118332872	Pitch in mm (P): 6.10, Insulated: Yes, Width: 22.1 mm
Qty.	60 ST	
Type	ZQV 4N/4 RD	Version
Order No.	<a href="#">2460800000</a>	Cross-connector (terminal), Plugged, red, 32 A, Number of poles: 4,
GTIN (EAN)	4050118476224	Pitch in mm (P): 6.10, Insulated: Yes, Width: 22.1 mm
Qty.	60 ST	
Type	ZQV 4N/5	Version
Order No.	<a href="#">1527980000</a>	Cross-connector (terminal), Plugged, orange, 32 A, Number of poles:
GTIN (EAN)	4050118332759	5, Pitch in mm (P): 6.10, Insulated: Yes, Width: 28.2 mm
Qty.	60 ST	
Type	ZQV 4N/5 BL	Version
Order No.	<a href="#">1528140000</a>	Cross-connector (terminal), Plugged, blue, 32 A, Number of poles: 5,
GTIN (EAN)	4050118333015	Pitch in mm (P): 6.10, Insulated: Yes, Width: 28.2 mm
Qty.	60 ST	
Type	ZQV 4N/5 RD	Version
Order No.	<a href="#">2460790000</a>	Cross-connector (terminal), Plugged, red, 32 A, Number of poles: 5,
GTIN (EAN)	4050118476217	Pitch in mm (P): 6.10, Insulated: Yes, Width: 28.2 mm
Qty.	60 ST	
Type	ZQV 4N/50	Version
Order No.	<a href="#">1528130000</a>	Cross-connector (terminal), Plugged, orange, 32 A, Number of poles:
GTIN (EAN)	4050118332902	50, Pitch in mm (P): 6.10, Insulated: Yes, Width: 303.7 mm
Qty.	5 ST	
Type	ZQV 4N/50 BL	Version
Order No.	<a href="#">1528240000</a>	Cross-connector (terminal), Plugged, blue, 32 A, Number of poles: 50,
GTIN (EAN)	4050118333121	Pitch in mm (P): 6.10, Insulated: Yes, Width: 303.7 mm
Qty.	5 ST	

## WFS 4 DI

**Weidmüller Interface GmbH & Co. KG**  
 Klingenbergstraße 26  
 D-32758 Detmold  
 Germany

www.weidmueller.com

## Accessories

Type	ZQV 4N/50 RD	Version
Order No.	<a href="#">2460730000</a>	Cross-connector (terminal), Plugged, red, 32 A, Number of poles: 50,
GTIN (EAN)	4050118476156	Pitch in mm (P): 6.10, Insulated: Yes, Width: 303.7 mm
Qty.	5 ST	
Type	ZQV 4N/6	Version
Order No.	<a href="#">1527990000</a>	Cross-connector (terminal), Plugged, orange, 32 A, Number of poles:
GTIN (EAN)	4050118332919	6, Pitch in mm (P): 6.10, Insulated: Yes, Width: 34.3 mm
Qty.	20 ST	
Type	ZQV 4N/6 BL	Version
Order No.	<a href="#">1528170000</a>	Cross-connector (terminal), Plugged, blue, 32 A, Number of poles: 6,
GTIN (EAN)	4050118332926	Pitch in mm (P): 6.10, Insulated: Yes, Width: 34.3 mm
Qty.	20 ST	
Type	ZQV 4N/6 RD	Version
Order No.	<a href="#">2460780000</a>	Cross-connector (terminal), Plugged, red, 32 A, Number of poles: 6,
GTIN (EAN)	4050118476200	Pitch in mm (P): 6.10, Insulated: Yes, Width: 34.3 mm
Qty.	20 ST	
Type	ZQV 4N/7	Version
Order No.	<a href="#">1528020000</a>	Cross-connector (terminal), Plugged, orange, 32 A, Number of poles:
GTIN (EAN)	4050118332780	7, Pitch in mm (P): 6.10, Insulated: Yes, Width: 40.4 mm
Qty.	20 ST	
Type	ZQV 4N/7 BL	Version
Order No.	<a href="#">1528180000</a>	Cross-connector (terminal), Plugged, blue, 32 A, Number of poles: 7,
GTIN (EAN)	4050118333114	Pitch in mm (P): 6.10, Insulated: Yes, Width: 40.4 mm
Qty.	20 ST	
Type	ZQV 4N/7 RD	Version
Order No.	<a href="#">2460770000</a>	Cross-connector (terminal), Plugged, red, 32 A, Number of poles: 7,
GTIN (EAN)	4050118476194	Pitch in mm (P): 6.10, Insulated: Yes, Width: 40.4 mm
Qty.	20 ST	
Type	ZQV 4N/8	Version
Order No.	<a href="#">1528030000</a>	Cross-connector (terminal), Plugged, orange, 32 A, Number of poles:
GTIN (EAN)	4050118332841	8, Pitch in mm (P): 6.10, Insulated: Yes, Width: 46.5 mm
Qty.	20 ST	
Type	ZQV 4N/8 BL	Version
Order No.	<a href="#">1528190000</a>	Cross-connector (terminal), Plugged, blue, 32 A, Number of poles: 8,
GTIN (EAN)	4050118332858	Pitch in mm (P): 6.10, Insulated: Yes, Width: 46.5 mm
Qty.	20 ST	
Type	ZQV 4N/8 RD	Version
Order No.	<a href="#">2460760000</a>	Cross-connector (terminal), Plugged, red, 32 A, Number of poles: 8,
GTIN (EAN)	4050118476187	Pitch in mm (P): 6.10, Insulated: Yes, Width: 46.5 mm
Qty.	20 ST	
Type	ZQV 4N/9	Version
Order No.	<a href="#">1528070000</a>	Cross-connector (terminal), Plugged, orange, 32 A, Number of poles:
GTIN (EAN)	4050118332797	9, Pitch in mm (P): 6.10, Insulated: Yes, Width: 52.6 mm
Qty.	20 ST	
Type	ZQV 4N/9 BL	Version
Order No.	<a href="#">1528220000</a>	Cross-connector (terminal), Plugged, blue, 32 A, Number of poles: 9,
GTIN (EAN)	4050118333107	Pitch in mm (P): 6.10, Insulated: Yes, Width: 52.6 mm
Qty.	20 ST	
Type	ZQV 4N/9 RD	Version
Order No.	<a href="#">2460750000</a>	Cross-connector (terminal), Plugged, red, 32 A, Number of poles: 9,
GTIN (EAN)	4050118476170	Pitch in mm (P): 6.10, Insulated: Yes, Width: 52.6 mm
Qty.	20 ST	

## WFS 4 DI

Weidmüller Interface GmbH &amp; Co. KG

Klingenbergstraße 26

D-32758 Detmold

Germany

www.weidmueller.com

## Accessories

## End bracket



Weidmüller's range of products includes end brackets that guarantee a permanent, reliable mounting on the terminal rail and prevent sliding. Versions with and without screws are available. The end brackets include marking options, also for group markers, and also a test plug holder.

## General ordering data

Type	WEW 35/2	Version
Order No.	<a href="#">1061200000</a>	End bracket, dark beige, TS 35, HB, Wemid, Width: 8 mm, 100 °C
GTIN (EAN)	4008190030230	
Qty.	50 ST	
Type	WEW 35/2 GR	Version
Order No.	<a href="#">1859200000</a>	End bracket, grey, TS 35, V-2, Wemid, Width: 8 mm, 100 °C
GTIN (EAN)	4032248411658	
Qty.	50 ST	
Type	WEW 35/2 SW	Version
Order No.	<a href="#">1061210000</a>	End bracket, black, TS 35, V-2, Wemid, Width: 8 mm, 100 °C
GTIN (EAN)	4032248136278	
Qty.	50 ST	
Type	WEW 35/2 VO GF SW	Version
Order No.	<a href="#">1479000000</a>	End bracket, black, TS 35, V-0, Wemid, Width: 8 mm, 130 °C
GTIN (EAN)	4050118286779	
Qty.	50 ST	

## WS 8/6



## WS/ DEK

MultiMark terminal markers use an innovative composite material made from two components. The hard base contour of the marker snaps securely into the connector. The elastic surface finish makes the marker easy to mount. This specially punched material enables the strips to be stretched to accommodate the slight variations in spacing that tend to add up, especially with long terminal blocks. Another advantage: the excellent printability of the surface material guarantees durable and wear-resistant labelling. A print resolution of 300 dpi also produces a very legible script.

Your benefits with MultiMark

- Firm hold and durable printing
- Continuous strips save installation time
- Easy mounting thanks to an innovative composite material
- Large label field for optimal legibility
- High flexibility thanks to manufacturer independence

## WFS 4 DI

Weidmüller Interface GmbH &amp; Co. KG

Klingenbergstraße 26

D-32758 Detmold

Germany

www.weidmueller.com

## Accessories

## General ordering data

Type	WS 8/6 MM WS	Version
Order No.	<a href="#">2007160000</a>	WS, Terminal marker, 8 x 6 mm, Weidmueller, white
GTIN (EAN)	4050118391879	
Qty.	600 ST	

## WS 12/6



## WS/ DEK

MultiMark terminal markers use an innovative composite material made from two components. The hard base contour of the marker snaps securely into the connector. The elastic surface finish makes the marker easy to mount. This specially punched material enables the strips to be stretched to accommodate the slight variations in spacing that tend to add up, especially with long terminal blocks. Another advantage: the excellent printability of the surface material guarantees durable and wear-resistant labelling. A print resolution of 300 dpi also produces a very legible script.

Your benefits with MultiMark

- Firm hold and durable printing
- Continuous strips save installation time
- Easy mounting thanks to an innovative composite material
- Large label field for optimal legibility
- High flexibility thanks to manufacturer independence

## General ordering data

Type	WS 12/6 MM WS	Version
Order No.	<a href="#">2007200000</a>	WS, Terminal marker, 12 x 6 mm, Weidmueller, white
GTIN (EAN)	4050118391886	
Qty.	600 ST	

## DEK 5/6



## WS/ DEK

MultiMark terminal markers use an innovative composite material made from two components. The hard base contour of the marker snaps securely into the connector. The elastic surface finish makes the marker easy to mount. This specially punched material enables the strips to be stretched to accommodate the slight variations in spacing that tend to add up, especially with long terminal blocks. Another advantage: the excellent printability of the surface material guarantees durable and wear-resistant labelling. A print resolution of 300 dpi also produces a very legible script.

Your benefits with MultiMark

- Firm hold and durable printing
- Continuous strips save installation time
- Easy mounting thanks to an innovative composite material
- Large label field for optimal legibility
- High flexibility thanks to manufacturer independence

## WFS 4 DI

Weidmüller Interface GmbH &amp; Co. KG

Klingenbergstraße 26

D-32758 Detmold

Germany

www.weidmueller.com

## Accessories

## General ordering data

Type	DEK 5/6 MM WS	Version
Order No.	<a href="#">2007120000</a>	Dekafix, Terminal marker, 5 x 6 mm, Weidmueller, white
GTIN (EAN)	4050118392104	
Qty.	600 ST	

## Blank



The Dekafix (DEK) marker is the universal marker for all conductor and plug-in connectors as well as for electronic sub-assemblies. The system is ideal for short number sequences and covers a wide range of ready-printed markers.

Strips for fast installation in only one work step. The printing is easy to read, rich in contrast and available in various widths.

- Large range of ready-to-use markers
  - Strips for fast installation
  - Terminal markers, suitable for all Weidmüller cable connectors
  - Available as blank MultiCard or with standard printing
- For custom printing: Please send us a file of our labeling software M-Print PRO or M-Print PRO Online (without installation) for your labeling specifications.

## General ordering data

Type	DEK 5/6 MC NE BL	Version
Order No.	<a href="#">1238290000</a>	Dekafix, Terminal marker, 5 x 6 mm, Pitch in mm (P): 6.00
GTIN (EAN)	4050118267327	Weidmueller, blue
Qty.	1000 ST	
Type	DEK 5/6 MC NE BR	Version
Order No.	<a href="#">1454900000</a>	Dekafix, Terminal marker, 5 x 6 mm, Pitch in mm (P): 6.00
GTIN (EAN)	4050118323313	Weidmueller, brown
Qty.	1000 ST	
Type	DEK 5/6 MC NE GE	Version
Order No.	<a href="#">1238280000</a>	Dekafix, Terminal marker, 5 x 6 mm, Pitch in mm (P): 6.00
GTIN (EAN)	4050118038750	Weidmueller, yellow
Qty.	1000 ST	
Type	DEK 5/6 MC NE GN	Version
Order No.	<a href="#">1238310000</a>	Dekafix, Terminal marker, 5 x 6 mm, Pitch in mm (P): 6.00
GTIN (EAN)	4050118271812	Weidmueller, green
Qty.	1000 ST	
Type	DEK 5/6 MC NE GR	Version
Order No.	<a href="#">1238330000</a>	Dekafix, Terminal marker, 5 x 6 mm, Pitch in mm (P): 6.00
GTIN (EAN)	4050118323306	Weidmueller, grey
Qty.	1000 ST	
Type	DEK 5/6 MC NE OR	Version
Order No.	<a href="#">1912090000</a>	Dekafix, Terminal marker, 5 x 6 mm, Pitch in mm (P): 6.00
GTIN (EAN)	4032248540525	Weidmueller, orange
Qty.	1000 ST	
Type	DEK 5/6 MC NE WS	Version
Order No.	<a href="#">1609820000</a>	Dekafix, Terminal marker, 5 x 6 mm, Pitch in mm (P): 6.00
GTIN (EAN)	4008190203436	Weidmueller, white
Qty.	1000 ST	

## WFS 4 DI

**Weidmüller Interface GmbH & Co. KG**  
 Klingenbergstraße 26  
 D-32758 Detmold  
 Germany

www.weidmueller.com

## Accessories

### Custom printing



The Dekafix (DEK) marker is the universal marker for all conductor and plug-in connectors as well as for electronic sub-assemblies. The system is ideal for short number sequences and covers a wide range of ready-printed markers.

Strips for fast installation in only one work step. The printing is easy to read, rich in contrast and available in various widths.

- Large range of ready-to-use markers
  - Strips for fast installation
  - Terminal markers, suitable for all Weidmüller cable connectors
  - Available as blank MultiCard or with standard printing
- For custom printing: Please send us a file of our labeling software M-Print PRO or M-Print PRO Online (without installation) for your labeling specifications.

### General ordering data

Type	DEK 5/6 MC SDR	Version	
Order No.	<a href="#">1609830000</a>		Dekafix, Terminal marker, 5 x 6 mm, Pitch in mm (P): 6.00
GTIN (EAN)	4008190456603		Weidmueller, To customer specification
Qty.	200 ST		

### Plus



The Dekafix (DEK) marker is the universal marker for all conductor and plug-in connectors as well as for electronic sub-assemblies. The system is ideal for short number sequences and covers a wide range of ready-printed markers.

Strips for fast installation in only one work step. The printing is easy to read, rich in contrast and available in various widths.

- Large range of ready-to-use markers
  - Strips for fast installation
  - Terminal markers, suitable for all Weidmüller cable connectors
  - Available as blank MultiCard or with standard printing
- For custom printing: Please send us a file of our labeling software M-Print PRO or M-Print PRO Online (without installation) for your labeling specifications.

### General ordering data

Type	DEK 5/6 PLUS MC NE WS	Version	
Order No.	<a href="#">1011320000</a>		Dekafix, Terminal marker, 5 x 6 mm, Pitch in mm (P): 6.00
GTIN (EAN)	4032248717644		Weidmueller, white
Qty.	1000 ST		

**Accessories**

**Custom printing**



The Dekafix (DEK) marker is the universal marker for all conductor and plug-in connectors as well as for electronic sub-assemblies. The system is ideal for short number sequences and covers a wide range of ready-printed markers.

Strips for fast installation in only one work step. The printing is easy to read, rich in contrast and available in various widths.

- Large range of ready-to-use markers
  - Strips for fast installation
  - Terminal markers, suitable for all Weidmüller cable connectors
  - Available as blank MultiCard or with standard printing
- For custom printing: Please send us a file of our labeling software M-Print PRO or M-Print PRO Online (without installation) for your labeling specifications.

**General ordering data**

Type	DEK 5/6 PLUS MC SDR	Version
Order No.	<a href="#">1038650000</a>	Dekafix, Terminal marker, 5 x 6 mm, Pitch in mm (P): 6.00
GTIN (EAN)	4032248767908	Weidmueller, To customer specification
Qty.	200 ST	

**Blank**

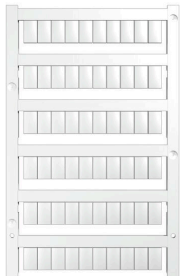

WS markers are the perfect match for the W-series connectors. Thanks to their system compatibility, the WS tags can also be used with the I-series and the Z-series. The large marking surfaces do not only permit long character strings but also multi-line text. WS markers are ideal for labels with long, customised character strings. Thanks to the proven MultiCard format, printing with PrintJet CONNECT oder/or Plotter is possible.

- Can be fitted in strips or individually
  - Markers in proven MultiCard format
- For custom printing: Please send us a file of our labeling software M-Print PRO or M-Print PRO Online (without installation) for your labeling specifications.

**General ordering data**

Type	WS 10/6 M MC NE WS	Version
Order No.	<a href="#">1818400000</a>	WS, Terminal marker, 10 x 6 mm, Pitch in mm (P): 6.00 Weidmueller,
GTIN (EAN)	4032248310876	Allen-Bradley, white
Qty.	600 ST	
Type	WS 10/6 M PLUS MC NE WS	Version
Order No.	<a href="#">2003780000</a>	WS, Terminal marker, 10 x 6 mm, Pitch in mm (P): 6.00 Weidmueller,
GTIN (EAN)	4050118424461	Allen-Bradley, white
Qty.	600 ST	

## WFS 4 DI

**Weidmüller Interface GmbH & Co. KG**

Klingenbergstraße 26  
D-32758 Detmold  
Germany

## Accessories

www.weidmueller.com

### Custom printing



WS markers are the perfect match for the W-series connectors. Thanks to their system compatibility, the WS tags can also be used with the I-series and the Z-series. The large marking surfaces do not only permit long character strings but also multi-line text. WS markers are ideal for labels with long, customised character strings. Thanks to the proven MultiCard format, printing with PrintJet CONNECT oder/or Plotter is possible.

- Can be fitted in strips or individually
- Markers in proven MultiCard format

For custom printing: Please send us a file of our labeling software M-Print PRO or M-Print PRO Online (without installation) for your labeling specifications.

### General ordering data

Type	WS 10/6 M PLUS MC SDR	Version
Order No.	<a href="#">2007780000</a>	WS, Terminal marker, 10 x 6 mm, Pitch in mm (P): 6.00 Weidmueller,
GTIN (EAN)	4050118393187	Allen-Bradley, To customer specification
Qty.	120 ST	

### Blank



WS markers are the perfect match for the W-series connectors. Thanks to their system compatibility, the WS tags can also be used with the I-series and the Z-series. The large marking surfaces do not only permit long character strings but also multi-line text. WS markers are ideal for labels with long, customised character strings. Thanks to the proven MultiCard format, printing with PrintJet CONNECT oder/or Plotter is possible.

- Can be fitted in strips or individually
- Markers in proven MultiCard format

For custom printing: Please send us a file of our labeling software M-Print PRO or M-Print PRO Online (without installation) for your labeling specifications.

### General ordering data

Type	WS 10/6 MC M NE BL	Version
Order No.	<a href="#">1069080000</a>	WS, Terminal marker, 10 x 6 mm, Pitch in mm (P): 6.00 Weidmueller,
GTIN (EAN)	4032248824618	Allen-Bradley, blue
Qty.	600 ST	
Type	WS 10/6 MC M NE GE	Version
Order No.	<a href="#">1917430000</a>	WS, Terminal marker, 10 x 6 mm, Pitch in mm (P): 6.00 Weidmueller,
GTIN (EAN)	4032248551637	Allen-Bradley, yellow
Qty.	600 ST	
Type	WS 10/6 MC M NE GN	Version
Order No.	<a href="#">1917420000</a>	WS, Terminal marker, 10 x 6 mm, Pitch in mm (P): 6.00 Weidmueller,
GTIN (EAN)	4032248551620	Allen-Bradley, green
Qty.	600 ST	

## WFS 4 DI

**Weidmüller Interface GmbH & Co. KG**  
 Klingenbergstraße 26  
 D-32758 Detmold  
 Germany

www.weidmueller.com

## Accessories

Type	WS 10/6 MC M NE RT	Version
Order No.	<a href="#">1917440000</a>	WS, Terminal marker, 10 x 6 mm, Pitch in mm (P): 6.00 Weidmueller,
GTIN (EAN)	4032248551644	Allen-Bradley, red
Qty.	600 ST	

### Custom printing



WS markers are the perfect match for the W-series connectors. Thanks to their system compatibility, the WS tags can also be used with the I-series and the Z-series. The large marking surfaces do not only permit long character strings but also multi-line text. WS markers are ideal for labels with long, customised character strings. Thanks to the proven MultiCard format, printing with PrintJet CONNECT oder/or Plotter is possible.

- Can be fitted in strips or individually
- Markers in proven MultiCard format

For custom printing: Please send us a file of our labeling software M-Print PRO or M-Print PRO Online (without installation) for your labeling specifications.

### General ordering data

Type	WS 10/6 MC M SDR	Version
Order No.	<a href="#">1818410000</a>	WS, Terminal marker, 10 x 6 mm, Pitch in mm (P): 6.00 Weidmueller,
GTIN (EAN)	4032248310883	Allen-Bradley, To customer specification
Qty.	120 ST	

### Blank



WS markers are the perfect match for the W-series connectors. Thanks to their system compatibility, the WS tags can also be used with the I-series and the Z-series. The large marking surfaces do not only permit long character strings but also multi-line text. WS markers are ideal for labels with long, customised character strings. Thanks to the proven MultiCard format, printing with PrintJet CONNECT oder/or Plotter is possible.

- Can be fitted in strips or individually
- Markers in proven MultiCard format

For custom printing: Please send us a file of our labeling software M-Print PRO or M-Print PRO Online (without installation) for your labeling specifications.

### General ordering data

Type	WS 10/6 MC NE WS	Version
Order No.	<a href="#">1828450000</a>	WS, Terminal marker, 10 x 6 mm, Pitch in mm (P): 6.00 Weidmueller,
GTIN (EAN)	4032248350513	Allen-Bradley, white
Qty.	600 ST	

## WFS 4 DI

Weidmüller Interface GmbH &amp; Co. KG

Klingenbergstraße 26

D-32758 Detmold

Germany

## Accessories

www.weidmueller.com

## Custom printing



WS markers are the perfect match for the W-series connectors. Thanks to their system compatibility, the WS tags can also be used with the I-series and the Z-series. The large marking surfaces do not only permit long character strings but also multi-line text. WS markers are ideal for labels with long, customised character strings. Thanks to the proven MultiCard format, printing with PrintJet CONNECT oder/or Plotter is possible.

- Can be fitted in strips or individually
- Markers in proven MultiCard format

For custom printing: Please send us a file of our labeling software M-Print PRO or M-Print PRO Online (without installation) for your labeling specifications.

## General ordering data

Type	WS 10/6 MC SDR	Version
Order No.	<a href="#">1828460000</a>	WS, Terminal marker, 10 x 6 mm, Pitch in mm (P): 6.00 Weidmueller,
GTIN (EAN)	4032248367399	Allen-Bradley, To customer specification
Qty.	120 ST	

## Blank



WS markers are the perfect match for the W-series connectors. Thanks to their system compatibility, the WS tags can also be used with the I-series and the Z-series. The large marking surfaces do not only permit long character strings but also multi-line text. WS markers are ideal for labels with long, customised character strings. Thanks to the proven MultiCard format, printing with PrintJet CONNECT oder/or Plotter is possible.

- Can be fitted in strips or individually
- Markers in proven MultiCard format

For custom printing: Please send us a file of our labeling software M-Print PRO or M-Print PRO Online (without installation) for your labeling specifications.

## General ordering data

Type	WS 10/6 PLUS MC NE WS	Version
Order No.	<a href="#">1046390000</a>	WS, Terminal marker, 10 x 6 mm, Pitch in mm (P): 6.00 Weidmueller,
GTIN (EAN)	4032248782109	Allen-Bradley, white
Qty.	600 ST	

## WFS 4 DI

Weidmüller Interface GmbH &amp; Co. KG

Klingenbergstraße 26

D-32758 Detmold

Germany

www.weidmueller.com

## Accessories

## Custom printing



WS markers are the perfect match for the W-series connectors. Thanks to their system compatibility, the WS tags can also be used with the I-series and the Z-series. The large marking surfaces do not only permit long character strings but also multi-line text. WS markers are ideal for labels with long, customised character strings. Thanks to the proven MultiCard format, printing with PrintJet CONNECT oder/or Plotter is possible.

- Can be fitted in strips or individually
- Markers in proven MultiCard format

For custom printing: Please send us a file of our labeling software M-Print PRO or M-Print PRO Online (without installation) for your labeling specifications.

## General ordering data

Type	WS 10/6 PLUS MC SDR	Version
Order No.	<a href="#">1046330000</a>	WS, Terminal marker, 10 x 6 mm, Pitch in mm (P): 6.00 Weidmueller,
GTIN (EAN)	4032248782031	Allen-Bradley, To customer specification
Qty.	120 ST	

## Blank



WS markers are the perfect match for the W-series connectors. Thanks to their system compatibility, the WS tags can also be used with the I-series and the Z-series. The large marking surfaces do not only permit long character strings but also multi-line text. WS markers are ideal for labels with long, customised character strings. Thanks to the proven MultiCard format, printing with PrintJet CONNECT oder/or Plotter is possible.

- Can be fitted in strips or individually
- Markers in proven MultiCard format

For custom printing: Please send us a file of our labeling software M-Print PRO or M-Print PRO Online (without installation) for your labeling specifications.

## General ordering data

Type	WS 12/6 MC NE BL	Version
Order No.	<a href="#">1773551693</a>	WS, Terminal marker, 12 x 6 mm, Pitch in mm (P): 6.00 Weidmueller,
GTIN (EAN)	4032248143269	Allen-Bradley, blue
Qty.	600 ST	
Type	WS 12/6 MC NE BR	Version
Order No.	<a href="#">1773551692</a>	WS, Terminal marker, 12 x 6 mm, Pitch in mm (P): 6.00 Weidmueller,
GTIN (EAN)	4032248143252	Allen-Bradley, brown
Qty.	600 ST	
Type	WS 12/6 MC NE GE	Version
Order No.	<a href="#">1773551687</a>	WS, Terminal marker, 12 x 6 mm, Pitch in mm (P): 6.00 Weidmueller,
GTIN (EAN)	4032248141937	Allen-Bradley, yellow
Qty.	600 ST	

## WFS 4 DI

**Weidmüller Interface GmbH & Co. KG**  
 Klingenbergstraße 26  
 D-32758 Detmold  
 Germany

www.weidmueller.com

## Accessories

Type	WS 12/6 MC NE OR	Version
Order No.	<a href="#">1773551690</a>	WS, Terminal marker, 12 x 6 mm, Pitch in mm (P): 6.00 Weidmueller,
GTIN (EAN)	4032248 143245	Allen-Bradley, orange
Qty.	600 ST	
Type	WS 12/6 MC NE RT	Version
Order No.	<a href="#">1773551686</a>	WS, Terminal marker, 12 x 6 mm, Pitch in mm (P): 6.00 Weidmueller,
GTIN (EAN)	4032248 141920	Allen-Bradley, red
Qty.	600 ST	
Type	WS 12/6 MC NE VI	Version
Order No.	<a href="#">1773551689</a>	WS, Terminal marker, 12 x 6 mm, Pitch in mm (P): 6.00 Weidmueller,
GTIN (EAN)	4032248 143238	Allen-Bradley, violet
Qty.	600 ST	
Type	WS 12/6 MC NE WS	Version
Order No.	<a href="#">1609900000</a>	WS, Terminal marker, 12 x 6 mm, Pitch in mm (P): 6.00 Weidmueller,
GTIN (EAN)	4008190203467	Allen-Bradley, white
Qty.	600 ST	

## Custom printing

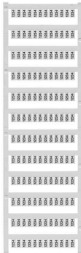

WS markers are the perfect match for the W-series connectors. Thanks to their system compatibility, the WS tags can also be used with the I-series and the Z-series. The large marking surfaces do not only permit long character strings but also multi-line text. WS markers are ideal for labels with long, customised character strings. Thanks to the proven MultiCard format, printing with PrintJet CONNECT oder/or Plotter is possible.

- Can be fitted in strips or individually
- Markers in proven MultiCard format

For custom printing: Please send us a file of our labeling software M-Print PRO or M-Print PRO Online (without installation) for your labeling specifications.

## General ordering data

Type	WS 12/6 MC SDR	Version
Order No.	<a href="#">1609910000</a>	WS, Terminal marker, 12 x 6 mm, Pitch in mm (P): 6.00 Weidmueller,
GTIN (EAN)	4008190456658	Allen-Bradley, To customer specification
Qty.	120 ST	

WFS 4 DI

**Weidmüller Interface GmbH & Co. KG**  
 Klingenbergstraße 26  
 D-32758 Detmold  
 Germany

www.weidmueller.com

Accessories

Blank



WS markers are the perfect match for the W-series connectors. Thanks to their system compatibility, the WS tags can also be used with the I-series and the Z-series. The large marking surfaces do not only permit long character strings but also multi-line text. WS markers are ideal for labels with long, customised character strings. Thanks to the proven MultiCard format, printing with PrintJet CONNECT oder/or Plotter is possible.

- Can be fitted in strips or individually
- Markers in proven MultiCard format

For custom printing: Please send us a file of our labeling software M-Print PRO or M-Print PRO Online (without installation) for your labeling specifications.

General ordering data

Type	WS 12/6 PLUS MC NE WS	Version
Order No.	<a href="#">1927530000</a>	WS, Terminal marker, 12 x 6 mm, Pitch in mm (P): 6.00 Weidmueller,
GTIN (EAN)	4032248574209	Allen-Bradley, white
Qty.	600 ST	

Custom printing

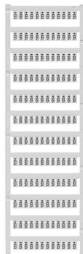

WS markers are the perfect match for the W-series connectors. Thanks to their system compatibility, the WS tags can also be used with the I-series and the Z-series. The large marking surfaces do not only permit long character strings but also multi-line text. WS markers are ideal for labels with long, customised character strings. Thanks to the proven MultiCard format, printing with PrintJet CONNECT oder/or Plotter is possible.

- Can be fitted in strips or individually
- Markers in proven MultiCard format

For custom printing: Please send us a file of our labeling software M-Print PRO or M-Print PRO Online (without installation) for your labeling specifications.

General ordering data

Type	WS 12/6 PLUS MC SDR	Version
Order No.	<a href="#">1927540000</a>	WS, Terminal marker, 12 x 6 mm, Pitch in mm (P): 6.00 Weidmueller,
GTIN (EAN)	4032248574711	Allen-Bradley, To customer specification
Qty.	120 ST	

**WFS 4 DI**

**Weidmüller Interface GmbH & Co. KG**  
 Klingenbergstraße 26  
 D-32758 Detmold  
 Germany

www.weidmueller.com

**Accessories**

**Blank**

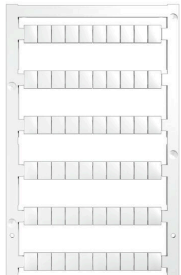

WS markers are the perfect match for the W-series connectors. Thanks to their system compatibility, the WS tags can also be used with the I-series and the Z-series. The large marking surfaces do not only permit long character strings but also multi-line text. WS markers are ideal for labels with long, customised character strings. Thanks to the proven MultiCard format, printing with PrintJet CONNECT oder/or Plotter is possible.

- Can be fitted in strips or individually
- Markers in proven MultiCard format

For custom printing: Please send us a file of our labeling software M-Print PRO or M-Print PRO Online (without installation) for your labeling specifications.

**General ordering data**

Type	WS 8/6 PLUS MC NE WS	Version
Order No.	<a href="#">1951880000</a>	WS, Terminal marker, 8 x 6 mm, Pitch in mm (P): 6.00 Weidmueller,
GTIN (EAN)	4032248632114	white
Qty.	600 ST	

**Custom printing**

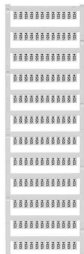

WS markers are the perfect match for the W-series connectors. Thanks to their system compatibility, the WS tags can also be used with the I-series and the Z-series. The large marking surfaces do not only permit long character strings but also multi-line text. WS markers are ideal for labels with long, customised character strings. Thanks to the proven MultiCard format, printing with PrintJet CONNECT oder/or Plotter is possible.

- Can be fitted in strips or individually
- Markers in proven MultiCard format

For custom printing: Please send us a file of our labeling software M-Print PRO or M-Print PRO Online (without installation) for your labeling specifications.

**General ordering data**

Type	WS 8/6 PLUS MC SDR	Version
Order No.	<a href="#">1038820000</a>	WS, Terminal marker, 8 x 6 mm, Pitch in mm (P): 6.00 Weidmueller,
GTIN (EAN)	4032248768073	To customer specification
Qty.	120 ST	

## WFS 4 DI

Weidmüller Interface GmbH &amp; Co. KG

Klingenbergstraße 26

D-32758 Detmold

Germany

www.weidmueller.com

## Accessories

## Marker holder

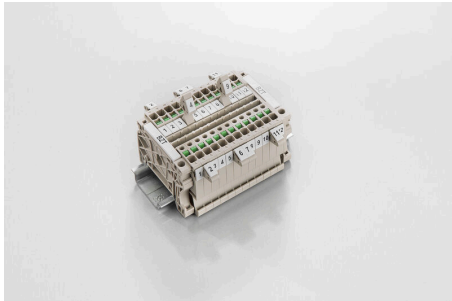

The marker holder offer the possibility of additional mounting of standard markers with a pitch of 5 or 5.1 mm. The angled holders can be optionally snapped together and could be mounted in all standard marking channels of the Klippon® Connect modular terminal blocks. Fitting marker types could be found under the respective accessories of the designation marking holder.

## General ordering data

Type	BZT 1 WS 10/5	Version	
Order No.	<a href="#">1805490000</a>	Accessories, Marker holder	
GTIN (EAN)	4032248270231		
Qty.	100 ST		
Type	BZT 1 ZA WS 10/5	Version	
Order No.	<a href="#">1805520000</a>	Accessories, Marker holder	
GTIN (EAN)	4032248270248		
Qty.	100 ST		

## End bracket

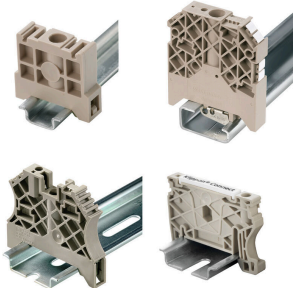

Weidmüller's range of products includes end brackets that guarantee a permanent, reliable mounting on the terminal rail and prevent sliding. Versions with and without screws are available. The end brackets include marking options, also for group markers, and also a test plug holder.

## General ordering data

Type	ZST 1	Version	
Order No.	<a href="#">1269070000</a>	Accessories, Accessories holder	
GTIN (EAN)	4050118094091		
Qty.	25 ST		

## Disconnect plugs



In contrast to the terminal blocks with integrated disconnect lever, our disconnect plugs can be completely detached or removed from the terminal block and the respective application and offer a flexible alternative solution to our standard disconnectors.

## WFS 4 DI

Weidmüller Interface GmbH &amp; Co. KG

Klingenbergstraße 26

D-32758 Detmold

Germany

www.weidmueller.com

## Accessories

## General ordering data

Type	DTLE 2.5/4	Version	
Order No.	<a href="#">2910530000</a>	Locking element (terminal), Wemid, red	
GTIN (EAN)	4099986519466		
Qty.	25 ST		

## Fuse holder



The fuse holder SIHA quickly turns a disconnect terminal into a fuse terminal: simply remove the disconnect lever and attach the fuse unit.

## General ordering data

Type	FSPG BK	Version	
Order No.	<a href="#">2869680000</a>	Fuse holder for feed-through modular terminal, black, 6.3 A, Pivoting,	
GTIN (EAN)	4064675623793	V-0, Wemid	
Qty.	25 ST		
Type	FSPG BL	Version	
Order No.	<a href="#">2869730000</a>	Fuse holder for feed-through modular terminal, blue, 6.3 A, Pivoting,	
GTIN (EAN)	4064675623854	V-0, Wemid	
Qty.	25 ST		
Type	FSPG LED 10-36V BK	Version	
Order No.	<a href="#">2869690000</a>	Fuse holder for feed-through modular terminal, black, 6.3 A, Pivoting,	
GTIN (EAN)	4064675623809	V-0, Wemid	
Qty.	25 ST		
Type	FSPG LED 10-36V BL	Version	
Order No.	<a href="#">2869740000</a>	Fuse holder for feed-through modular terminal, blue, 6.3 A, Pivoting,	
GTIN (EAN)	4064675623861	V-0, Wemid	
Qty.	25 ST		
Type	FSPG LED 100-250V BK	Version	
Order No.	<a href="#">2869700000</a>	Fuse holder for feed-through modular terminal, black, 6.3 A, Pivoting,	
GTIN (EAN)	4064675623816	V-0, Wemid	
Qty.	25 ST		
Type	FSPG LED 100-250V BL	Version	
Order No.	<a href="#">2869750000</a>	Fuse holder for feed-through modular terminal, blue, 6.3 A, Pivoting,	
GTIN (EAN)	4064675623878	V-0, Wemid	
Qty.	25 ST		
Type	FSPG LED 30-70V BK	Version	
Order No.	<a href="#">2869710000</a>	Fuse holder for feed-through modular terminal, black, 6.3 A, Pivoting,	
GTIN (EAN)	4064675623823	V-0, Wemid	
Qty.	25 ST		
Type	FSPG LED 30-70V BL	Version	
Order No.	<a href="#">2869760000</a>	Fuse holder for feed-through modular terminal, blue, 6.3 A, Pivoting,	
GTIN (EAN)	4064675623885	V-0, Wemid	
Qty.	25 ST		

## WFS 4 DI

**Weidmüller Interface GmbH & Co. KG**  
 Klingenbergstraße 26  
 D-32758 Detmold  
 Germany

www.weidmueller.com

## Accessories

Type	FSPG LED 60-150V BK	Version
Order No.	<a href="#">2869720000</a>	Fuse holder for feed-through modular terminal, black, 6.3 A, Pivoting,
GTIN (EAN)	4064675623830	V-0, Wemid
Qty.	25 ST	
Type	FSPG LED 60-150V BL	Version
Order No.	<a href="#">2869770000</a>	Fuse holder for feed-through modular terminal, blue, 6.3 A, Pivoting,
GTIN (EAN)	4064675623892	V-0, Wemid
Qty.	25 ST	

## Cross-connections



The distribution or multiplication of a potential to adjoining terminal blocks is realized via a cross-connection. Additional wiring effort can be easily avoided. Even if the poles are broken out, contact reliability in the terminal blocks is still ensured. Our portfolio offers pluggable and screwable cross-connection systems for modular terminal blocks.

## General ordering data

Type	VH 20/5/3.4	Version
Order No.	<a href="#">0446100000</a>	Dummy fuse
GTIN (EAN)	4008190519742	
Qty.	10 ST	