

TOPL 24VDC 230VAC0.1A

Weidmüller Interface GmbH & Co. KG
 Klingenbergstraße 26
 D-32758 Detmold
 Germany

www.weidmueller.com



The all-rounder. Compact relay modules, 6 mm width with extensive accessories, maximum vibration resistance, and unlimited cross-connection possibilities.

- 0.1 A AC output current
- 1 NO contact
- Compatible with the complete range of TERMSERIES accessories
- 100 % vibration-proof thanks to enclosed design

General ordering data

Version	TERMSERIES-compact, Solid-state relay, Rated control voltage: 24 V DC $\pm 20\%$, Rated switching voltage: 230 V AC, Continuous current: 0.1 A, PUSH IN
Order No.	2773630000
Type	TOPL 24VDC 230VAC0.1A
GTIN (EAN)	4064675037408
Qty.	10 items

TOPL 24VDC 230VAC0.1A

Weidmüller Interface GmbH & Co. KG
Klingenbergstraße 26
D-32758 Detmold
Germany

www.weidmueller.com

Technical data

Approvals

Approvals



Dimensions and weights

Depth	62.5 mm	Depth (inches)	2.4606 inch
Height	89.4 mm	Height (inches)	3.5197 inch
Width	6.4 mm	Width (inches)	0.252 inch
Net weight	28 g		

Temperatures

Storage temperature	-40 °C...85 °C	Ambient temperature	-40 °C...60 °C
Operating temperature		Humidity	5-85% relative humidity, Tu = 40°C, without condensation

Probability of failure

MTTF	969 a
------	-------

Environmental Product Compliance

RoHS Compliance Status	Compliant with exemption
RoHS Exemption (if applicable/known)	7a, 7cl
REACH SVHC	Lead 7439-92-1

Control side

Rated control voltage	24 V DC \pm 20 %	Rated current DC	11.5 mA
Power rating	280 mW	Status indicator	Green LED
Protective circuit	Suppressor diode		

Load side

Rated switching voltage	230 V AC	Continuous current	0.1 A
Max. switching frequency at rated load	10 Hz	Switch-on delay	Approx. 10 ms
Switch-off delay	Approx. 10 ms	Min. switching current	1 mA
Protective circuit, load side	Suppressor diode	Contact type	1 NO contact (Triac (zero-cross switch))

General data

Operating altitude	\leq 2000 m, above sea level		
Mounting rail	TS 35		
Test button available	No		
Mechanical switch position indicator	No		
Colour	black		
UL94 flammability rating component	Component	Housing	
	UL94 flammability rating	V-0	
	Component	Relay status indicator	
	UL94 flammability rating	V-2	
	Component	Pusher	

TOPL 24VDC 230VAC0.1A

Weidmüller Interface GmbH & Co. KG
 Klingenbergstraße 26
 D-32758 Detmold
 Germany

www.weidmueller.com

Technical data

UL94 flammability rating V-0

Insulation coordination

Pollution severity	2	Surge voltage category	III
Clearance and creepage distances for control side - load side	≥ 8 mm	Dielectric strength for control side - load side	4 kVeff / 1 Min.
Type of isolation at input and output	reinforced insulation	Impulse withstand voltage	6 kV (1.2/50 µs)
Protection degree	IP20		

Connection data

Stripping length	9 mm	Wire connection method	PUSH IN
Stripping length, rated connection	9 mm	Clamping range, rated connection	1.5 mm ²
Clamping range, min.	0.14 mm ²	Clamping range, max.	2.5 mm ²
Wire connection cross section AWG, min.	AWG 26	Wire connection cross section AWG, max.	AWG 14
Wire cross-section, solid, min.	0.5 mm ²	Wire cross-section, solid, max.	1.5 mm ²
Wire cross-section, solid, min. (AWG)	AWG 26	Wire cross-section, solid, max. (AWG)	AWG 14
Wire connection cross section, finely stranded, min.	0.35 mm ²	Wire connection cross section, finely stranded, max.	2.5 mm ²
Wire cross-section, finely stranded, min. (AWG)	AWG 26	Wire cross-section, finely stranded, max. (AWG)	AWG 14
Wire connection cross-section, finely stranded with wire-end ferrules DIN 46228/4, min.	0.14 mm ²	Wire connection cross-section, finely stranded with wire-end ferrules DIN 46228/4, max.	1.5 mm ²
Conductor cross-section, flexible, AEH (DIN 46228-1), min.	0.5 mm ²	Conductor cross-section, flexible, AEH (DIN 46228-1), max.	1.5 mm ²
Blade size	0.6 x 3.5 mm		

Classifications

ETIM 8.0	EC001504	ETIM 9.0	EC001504
ETIM 10.0	EC001504	ECLASS 14.0	27-37-16-04
ECLASS 15.0	27-37-16-04		

Wiring diagram

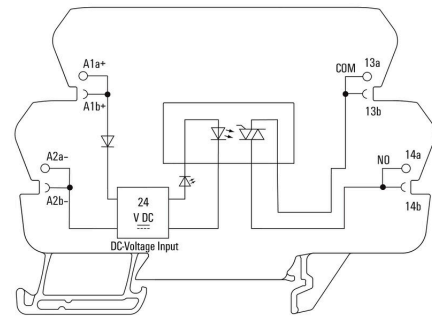

Derating curve

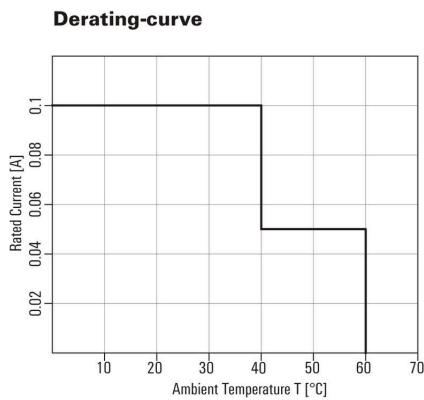

Graph

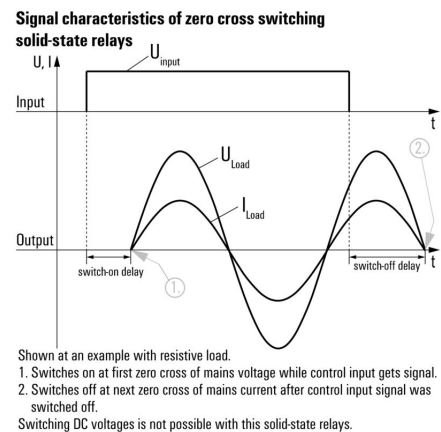

Dimensional drawing

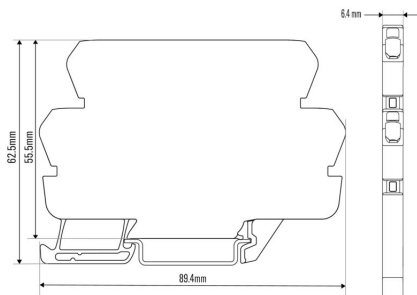

Miscellaneous

Type code solid-state relay



TOPL 24VDC 230VAC0.1A

Weidmüller Interface GmbH & Co. KG

Klingenbergstraße 26
D-32758 Detmold
Germany

www.weidmueller.com

Accessories

Blank

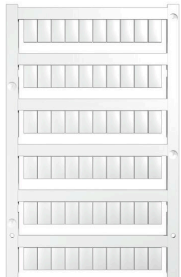

WS markers are the perfect match for the W-series connectors. Thanks to their system compatibility, the WS tags can also be used with the I-series and the Z-series. The large marking surfaces do not only permit long character strings but also multi-line text. WS markers are ideal for labels with long, customised character strings. Thanks to the proven MultiCard format, printing with PrintJet CONNECT oder/or Plotter is possible.

- Can be fitted in strips or individually
- Markers in proven MultiCard format

For custom printing: Please send us a file of our labeling software M-Print PRO or M-Print PRO Online (without installation) for your labeling specifications.

General ordering data

Type	WS 10/6 M MC NE WS	Version	
Order No.	1818400000	WS, Terminal marker, 10 x 6 mm, Pitch in mm (P): 6.00 Weidmueller,	
GTIN (EAN)	4032248310876	Allen-Bradley, white	
Qty.	600 ST		

Cross-connections



Adjustable cross-connections

Increase the flexibility of your cross-connections. The TERMSERIES CROSS-CONNECTION (TCC) enables individually adjustable cross-connections with up to 51 poles. The maximum number of pluggable poles has been increased to 32 poles. The strip material can be shortened to the required length very easily. The cross-connectors convince thanks to their easy handling and visibility as well as their universal connection possibilities. An additional web prevents the spring from deforming during assembly.

- Individually adjustable cross-connection with 51 poles
- Additional bar to avoid deformation of the spring
- Increased cross-connection – up to 32 poles possible
- Vibration resistance

General ordering data

Type	TCC 6.4/51 RD	Version	
Order No.	2556410000	TERMSERIES, Cross-connector	
GTIN (EAN)	4050118566925		
Qty.	10 ST		
Type	TCC 6.4/51 OR	Version	
Order No.	2556370000	TERMSERIES, Cross-connector	
GTIN (EAN)	4050118566680		
Qty.	10 ST		
Type	TCC 6.4/51 BL	Version	
Order No.	2556450000	TERMSERIES, Cross-connector	
GTIN (EAN)	4050118566963		
Qty.	10 ST		

TOPL 24VDC 230VAC0.1A

Weidmüller Interface GmbH & Co. KG
 Klingenbergstraße 26
 D-32758 Detmold
 Germany

www.weidmueller.com

Accessories

Type	TCC 6.4/51 BK	Version
Order No.	2556490000	TERMSERIES, Cross-connector
GTIN (EAN)	4050118567007	
Qty.	10 ST	
Type	TCC 6.4/2 OR	Version
Order No.	2556350000	TERMSERIES, Cross-connector
GTIN (EAN)	4050118566826	
Qty.	10 ST	
Type	TCC 6.4/2 BL	Version
Order No.	2556430000	TERMSERIES, Cross-connector
GTIN (EAN)	4050118566949	
Qty.	10 ST	
Type	TCC 6.4/2 BK	Version
Order No.	2556470000	TERMSERIES, Cross-connector
GTIN (EAN)	4050118566987	
Qty.	10 ST	
Type	TCC 6.4/10 RD	Version
Order No.	2556400000	TERMSERIES, Cross-connector
GTIN (EAN)	4050118566918	
Qty.	10 ST	
Type	TCC 6.4/10 OR	Version
Order No.	2556360000	TERMSERIES, Cross-connector
GTIN (EAN)	4050118566673	
Qty.	10 ST	
Type	TCC 6.4/10 BL	Version
Order No.	2556440000	TERMSERIES, Cross-connector
GTIN (EAN)	4050118566956	
Qty.	10 ST	
Type	TCC 6.4/10 BK	Version
Order No.	2556480000	TERMSERIES, Cross-connector
GTIN (EAN)	4050118566994	
Qty.	10 ST	
Type	TCC 12.8/26 RD	Version
Order No.	2556420000	TERMSERIES, Cross-connector
GTIN (EAN)	4050118566932	
Qty.	10 ST	
Type	TCC 12.8/26 OR	Version
Order No.	2556380000	TERMSERIES, Cross-connector
GTIN (EAN)	4050118566697	
Qty.	10 ST	
Type	TCC 12.8/26 BL	Version
Order No.	2556460000	TERMSERIES, Cross-connector
GTIN (EAN)	4050118566970	
Qty.	10 ST	
Type	TCC 12.8/26 BK	Version
Order No.	2556500000	TERMSERIES, Cross-connector
GTIN (EAN)	4050118567014	
Qty.	10 ST	
Type	TCC 6.4/2 RD	Version
Order No.	2556390000	TERMSERIES, Cross-connector
GTIN (EAN)	4050118566901	
Qty.	10 ST	

TOPL 24VDC 230VAC0.1A

Weidmüller Interface GmbH & Co. KG
 Klingenbergstraße 26
 D-32758 Detmold
 Germany

www.weidmueller.com

Accessories

Slotted screwdriver



VDE insulated slot-head screwdriver, SDI DIN 7437, ISO 2380/2, drive output acc. to DIN 5264, ISO 2380/1. SoftFinish grip

General ordering data

Type	SDIS 0.6X3.5X100	Version	
Order No.	2749810000	Screwdriver, Blade width (B): 3.5 mm, Blade length: 100 mm, Blade thickness (A): 0.6 mm	
GTIN (EAN)	4050118897012		
Qty.	1 ST		
Type	SDS 0.6X3.5X100	Version	
Order No.	2749340000	Screwdriver, Blade width (B): 3.5 mm, Blade length: 100 mm, Blade thickness (A): 0.6 mm	
GTIN (EAN)	4050118895568		
Qty.	1 ST		

Interface adapters



Faster signal wiring with less space

To reduce wiring times, pre-assembled cables are used between the control system and the interface level and are simply connected to the TERMSERIES adapter. This enables throughput times in electrical cabinet building to be significantly reduced. The adapter has a universal fit and offers a genuine space advantage in interaction with the TERMSERIES products with identical contours.

- Reduced wiring time due to plug-and-play concept with pre-assembled cables
- Can be applied to the input and output sides of the TERMSERIES
- Ready for plus and minus switching logic
- High space-saving due to universal fit to other TERMSERIES products

General ordering data

Type	TIA F10	Version	
Order No.	1463520000	TERMSERIES, Adapter, 10-pole plug according to DIN EN 60603-13, long locking lever, Number of signal paths: 8, Rated voltage DC : 24 V, Rated current (per signal path): 125 mA	
GTIN (EAN)	4050118323535		
Qty.	1 ST		

TOPL 24VDC 230VAC0.1A

Weidmüller Interface GmbH & Co. KG

Klingenbergstraße 26
D-32758 Detmold
Germany

www.weidmueller.com

Accessories

TERMSERIES interface adapter

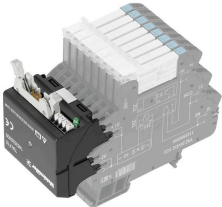

Faster signal wiring with less space

To reduce wiring times, pre-assembled cables are used between the control system and the interface level and are simply connected to the TERMSERIES adapter. This enables throughput times in electrical cabinet building to be significantly reduced. The adapter has a universal fit and offers a genuine space advantage in interaction with the TERMSERIES products with identical contours.

- Reduced wiring time due to plug-and-play concept with pre-assembled cables
- Can be applied to the input and output sides of the TERMSERIES
- Ready for plus and minus switching logic
- High space-saving due to universal fit to other TERMSERIES products

General ordering data

Type	TIA SUBD 15S	Version
Order No.	1463530000	TERMSERIES, Adapter, Sub-D, 15-pole, DIN 41652 / IEC 60807,
GTIN (EAN)	4050118323542	Number of signal paths: 8, Rated voltage DC : 24 V, Rated current (per
Qty.	1 ST	signal path): 125 mA

Interface adapters

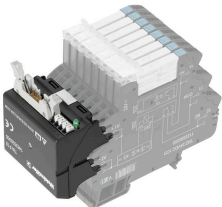

Faster signal wiring with less space

To reduce wiring times, pre-assembled cables are used between the control system and the interface level and are simply connected to the TERMSERIES adapter. This enables throughput times in electrical cabinet building to be significantly reduced. The adapter has a universal fit and offers a genuine space advantage in interaction with the TERMSERIES products with identical contours.

- Reduced wiring time due to plug-and-play concept with pre-assembled cables
- Can be applied to the input and output sides of the TERMSERIES
- Ready for plus and minus switching logic
- High space-saving due to universal fit to other TERMSERIES products

General ordering data

Type	TIAL F10	Version
Order No.	1463540000	TERMSERIES, Adapter, 10-pole plug according to DIN EN 60603-13,
GTIN (EAN)	4050118323559	long locking lever, Number of signal paths: 8, Rated voltage DC : 24 V,
Qty.	1 ST	Rated current (per signal path): 125 mA
Type	TIAL F20	Version
Order No.	1463550000	TERMSERIES, Adapter, 20-pole plug according to DIN EN 60603-13,
GTIN (EAN)	4050118331783	long locking lever, Number of signal paths: 16, Rated voltage DC : 24
Qty.	1 ST	V, Rated current (per signal path): 60 mA

Accessories

Partition plate



Versatile separation plates
 Separation plates can be used to group together signals visually, to electrically isolate modules and to insert markings for a better overview. This makes them a particularly versatile accessory. Separation plates increase the clearance and creepage distances between two modules, thus increasing the rated insulation voltage between two modules to up to 600 V. Double separation plates can be marked with WAD5 or WS10/5 markers and enable continuous cross-connections. Installation is made easier with the perforations to individually break out the cross-connection channels.

- Partition plates visually separates groups from each other
- Indentations for individual breaking out the crossconnection channels
- Partition plates isolates between two modules by increasing the clearance and creepage distances of up to 600 V

General ordering data

Type	TW TXS/TXZ R3.2	Version	
Order No.	1240800000	TERMSERIES, Partition plate	
GTIN (EAN)	4050118028188		
Qty.	10 ST		
Type	TXL PP	Version	
Order No.	2774090000	TERMSERIES-compact, Partition plate	
GTIN (EAN)	4064675037866		
Qty.	10 ST		

Feed through module



Precision-fit feed-through terminals
 The precisely fitting terminals enable potentials to be brought from the control side to the load side and vice versa. Due to the compatibility with the TERMSERIES, there is a uniform test system with a standardised test tap.

General ordering data

Type	TXPL FT	Version	
Order No.	2774080000	TERMSERIES-compact, Feed-through terminal, PUSH IN	
GTIN (EAN)	4064675037859		
Qty.	1 ST		

TOPL 24VDC 230VAC0.1A

Weidmüller Interface GmbH & Co. KG
Klingenbergstraße 26
D-32758 Detmold
Germany

www.weidmueller.com

Accessories

Supply module



Space-saving feed-in terminals
For easy feed-in of neutral or negative potentials at the input of switched potentials at the output. Cross-connections enable space-saving connection of sensors and actuators without additional feed-through terminal blocks.

General ordering data

Type	TXPL S	Version	
Order No.	2774100000	TERMSERIES-compact, Supply module, PUSH IN	
GTIN (EAN)	4064675037873		
Qty.	1 ST		