

DRL173024L

Weidmüller Interface GmbH & Co. KG

Klingenbergstraße 26

D-32758 Detmold

Germany

www.weidmueller.com

Product image



Similar to illustration

Individual relays within the D-SERIES DRL

- 1 CO contact
- Optional AC or DC coils
- With integrated status LED

General ordering data

Version	D-SERIES DRL, Relay, Number of contacts: 1, CO contact AgSnO, Rated control voltage: 24 V DC, Continuous current: 16 A, Flat blade connections (4.8 mm x 0.5 mm), Test button available: No
Order No.	2765110000
Type	DRL173024L
GTIN (EAN)	4064675077084
Qty.	20 items

DRL173024L

Weidmüller Interface GmbH & Co. KG

Klingenbergstraße 26

D-32758 Detmold

Germany

www.weidmueller.com

Technical data

Approvals

Approvals



ROHS Conform

UL File Number Search [UL Website](#)

Certificate No. (cURus) E312083

Dimensions and weights

Depth	36 mm	Depth (inches)	1.4173 inch
Height	28 mm	Height (inches)	1.1024 inch
Width	21.5 mm	Width (inches)	0.8465 inch
Net weight	36.4 g		

Temperatures

Storage temperature	-25 °C...55 °C	Ambient temperature	-25 °C...55 °C
Operating temperature		Humidity	35 % to 85 % relative humidity level

Environmental Product Compliance

RoHS Compliance Status	Compliant without exemption
REACH SVHC	No SVHC above 0.1 wt%

Rated data UL

Certificate No. (cURus)	E312083
-------------------------	---------

Control side

Rated control voltage	24 V DC	Rated current DC	36.9 mA
Power rating	0.9 W	Coil resistance	630 Ω ± 10 %
Status indicator	Green LED		

Load side

Rated switching voltage	250 V AC	Continuous current	16 A
Max. switching frequency at rated load	0.1 Hz	Max. switching voltage, AC	250 V
Inrush current	80 A / 50 ms	AC switching capacity (resistive), max.	4000 VA
DC switching capacity (resistive), max.	480 W @ 24 V	Switch-on delay	<20 ms
Switch-off delay	<20 ms	Contact type	1 CO contact (AgSnO)
Mechanical service life	10 x 10 ⁶ switching cycles	Min. switching power	10 mA @ 12 V

General data

Test button available	No	
Mechanical switch position indicator	Yes	
Colour	Transparent	
UL94 flammability rating component	Component	Relay cover
	UL94 flammability rating	V-2
	Component	Relay baseplate
	UL94 flammability rating	V-0
	Component	Relay status indicator
	UL94 flammability rating	HB

Technical data

Insulation coordination

Rated voltage	250 V	Pollution severity	3
Surge voltage category	III	Insulating material group	IIIa
Clearance and creepage distances for control side - load side	≥ 4 mm	Dielectric strength for control side - load side	2.5 kVeff / 1 min
Dielectric strength of neighbouring contacts	2 kVeff / 1 min	Dielectric strength of open contact	1.2 kVeff / 1 min.
Impulse withstand voltage	5 kV (1.2/50 µs)	Protection degree	IP20

Further details of approvals / standards

Certificate No. (cURus)	E312083
-------------------------	---------

Connection data

Wire connection method	Flat blade connections (4.8 mm x 0.5 mm)
------------------------	---------------------------------------------

Classifications

ETIM 8.0	EC001437	ETIM 9.0	EC001437
ETIM 10.0	EC001437	ECLASS 14.0	27-37-16-01
ECLASS 15.0	27-37-16-01		

Drawings

Wiring diagram

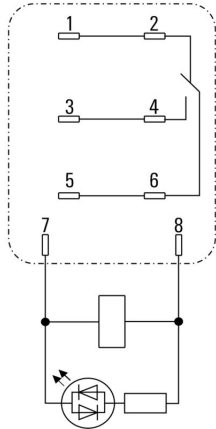

View of Pins from below

DC load limit curve

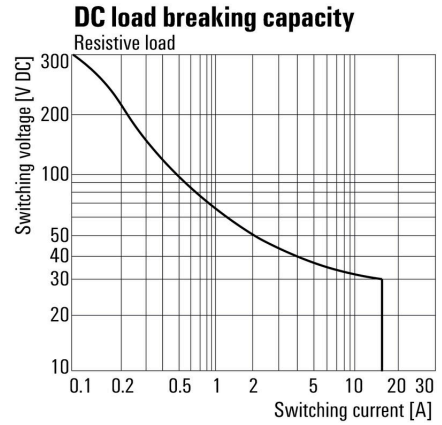

DC load limit curve Resistive load

Graph

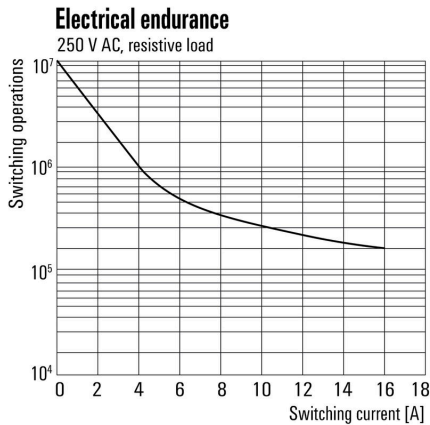

Electrical service life

Graph

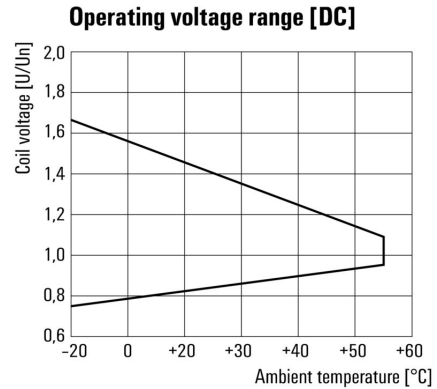

DC operational voltage range

Dimensional drawing

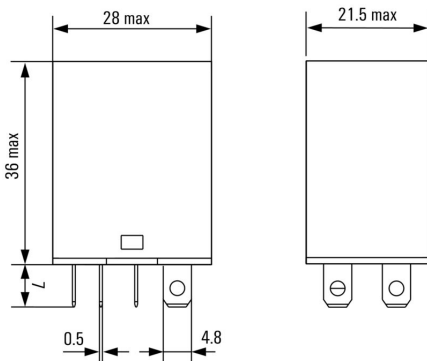

Miscellaneous



Type codes

DRL173024L

Weidmüller Interface GmbH & Co. KG
 Klingenbergstraße 26
 D-32758 Detmold
 Germany

www.weidmueller.com

Accessories

Sockets



Relay sockets for the D-SERIES DRL relays

- 2, 3 and 4 CO contacts
- Screw connection

General ordering data

Type	SLD F 2CO	Version	
Order No.	7760056225	D-SERIES DRL, Relay socket, Number of contacts: 2, CO contact,	
GTIN (EAN)	6944169634017	Continuous current: 10 A, Screw connection	
Qty.	10 ST		

Retaining clips

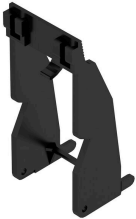

Retaining clip for D-SERIES DRM relays

- Metal and plastic retaining clip

General ordering data

Type	DRM/DRL CLIP M	Version	
Order No.	7760056108	D-SERIES, Retaining clip	
GTIN (EAN)	4032248855568		
Qty.	10 ST		

LED



Pluggable protective modules for the D-SERIES relay sockets, with optional protective functions.

- With green LED

General ordering data

Type	RIM 3 6/24VUC	Version	
Order No.	7940018457	D-SERIES, LED module, Rated control voltage: 6...24 V UC, Plug-in connection	
GTIN (EAN)	4032248878192		
Qty.	10 ST		

DRL173024L

Weidmüller Interface GmbH & Co. KG
 Klingenbergstraße 26
 D-32758 Detmold
 Germany

www.weidmueller.com

Accessories

LED / free-wheel diode



Pluggable protective modules for the D-SERIES relay sockets, with optional protective functions.

- With green LED and free-wheeling diode

General ordering data

Type	RIM 2 6/24VDC	Version	
Order No.	7760056015	D-SERIES, LED module with freewheel diode, Rated control voltage:	
GTIN (EAN)	4032248878116	6...24 V DC, Plug-in connection	
Qty.	10 ST		

Protection modules



Pluggable protective modules for the D-SERIES relay sockets, with optional protective functions.

- With free-wheeling diode or RC filter

General ordering data

Type	RIM 1 6/230VDC	Version	
Order No.	7760056169	D-SERIES, Free-wheeling diode, Rated control voltage: 6...230 V, Plug-	
GTIN (EAN)	4032248967728	in connection	
Qty.	10 ST		

LED



Pluggable protective modules for the D-SERIES relay sockets, with optional protective functions.

- With green LED

General ordering data

Type	RIM 3 24/60VUC	Version	
Order No.	7760056018	D-SERIES, LED module, Rated control voltage: 24...60 V UC, Plug-in	
GTIN (EAN)	4032248878130	connection	
Qty.	10 ST		

DRL173024L

Weidmüller Interface GmbH & Co. KG
 Klingenbergstraße 26
 D-32758 Detmold
 Germany

Accessories

www.weidmueller.com

LED / free-wheel diode



Pluggable protective modules for the D-SERIES relay sockets, with optional protective functions.

- With green LED and free-wheeling diode

General ordering data

Type	RIM 2 24/60VDC	Version	
Order No.	7760056016	D-SERIES, LED module with freewheel diode, Rated control voltage:	
GTIN (EAN)	4032248878123	24...60 V DC, Plug-in connection	
Qty.	10 ST		

Blank

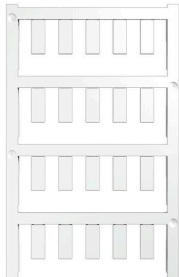

ESG is the tried-and-tested marker in MultiCard format for use on many well-known electrical devices. The result is high-quality device marking with a high-contrast appearance.

Various types are available for devices from manufacturers like Siemens, ABB, Beckhoff etc.

Advantages at a glance:

- Tags for universal usage, self-adhesive or clip-on tags, depending on type
- For aligned equipment, e.g. circuit breakers, we supply ESG markers for clipping onto tag rails
- Individual laser-quality printing according to specifications

For custom printing: Please send us a file of our labeling software M-Print PRO or M-Print PRO Online (without installation) for your labeling specifications.

General ordering data

Type	ESG 6/15 K MC NE WS	Version	
Order No.	1880100000	ESG, Device markers x 15 mm, PA 66, Colour: white, Self-adhesive	
GTIN (EAN)	4032248478781		
Qty.	200 ST		
Type	ESG 6/15 K MC NE GE	Version	
Order No.	1880130000	ESG, Device markers x 15 mm, PA 66, Colour: yellow, Self-adhesive	
GTIN (EAN)	4032248478910		
Qty.	200 ST		
Type	ESG 6/17 K MC NE GE	Version	
Order No.	1880110000	ESG, Device markers x 17 mm, PA 66, Colour: yellow, Self-adhesive	
GTIN (EAN)	4032248478798		
Qty.	200 ST		
Type	ESG 6/17 K MC NE WS	Version	
Order No.	1880120000	ESG, Device markers x 17 mm, PA 66, Colour: white, Self-adhesive	
GTIN (EAN)	4032248478804		
Qty.	200 ST		

DRL173024L

Weidmüller Interface GmbH & Co. KG
 Klingenbergstraße 26
 D-32758 Detmold
 Germany

www.weidmueller.com

Accessories

ESG 6/15



Guaranteed long service life: ESG

The multi-colour and multi-format labels have a strong adhesive layer to ensure the best possible adhesion to the underlying surface. Double laminated polyester makes the basic material very thin and yet extremely tear-resistant.

Your benefits with MultiMark

- “Different materials for various requirements”
- Can be used with equipment from many manufacturers
- Device markers with a familiar design

General ordering data

Type	ESG 6/15 MM WS	Version	
Order No.	2619940000	ESG, Device markers, 6 x 15 mm, white	
GTIN (EAN)	4050118626148		
Qty.	3000 ST		

ESG 6/17



Guaranteed long service life: ESG

The multi-colour and multi-format labels have a strong adhesive layer to ensure the best possible adhesion to the underlying surface. Double laminated polyester makes the basic material very thin and yet extremely tear-resistant.

Your benefits with MultiMark

- “Different materials for various requirements”
- Can be used with equipment from many manufacturers
- Device markers with a familiar design

General ordering data

Type	ESG 6/17 MM WS	Version	
Order No.	2005100000	ESG, Device markers, 6 x 17 mm, white	
GTIN (EAN)	4050118390728		
Qty.	3000 ST		

Counterpart

Sockets



- Relay sockets for the D-SERIES DRL relays
- 2, 3 and 4 CO contacts
 - Screw connection

General ordering data

Type	SLD F 2CO	Version	
Order No.	7760056225	D-SERIES DRL, Relay socket, Number of contacts: 2, CO contact,	
GTIN (EAN)	6944169634017	Continuous current: 10 A, Screw connection	
Qty.	10 ST		