

## B2CF 3.50/08/180LR SN BK BX SO

**Weidmüller Interface GmbH & Co. KG**  
 Klingenbergstraße 26  
 D-32758 Detmold  
 Germany

www.weidmueller.com

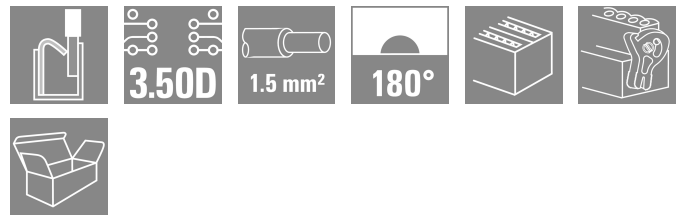
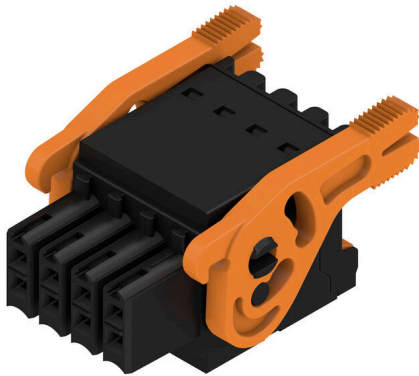

Similar to illustration

Two-row female plug with PUSH IN spring connection

- Simply insert the prepared wire - and you're done
- Intuitive to use because
- the wire-entry area and handling area are clearly separated
- Integrated push-buttons for opening the terminal point
- High component density because of low heights
- Optional: locking and releasing require no tools when using Weidmüller's release latch (LR) or release lever (LH)

### General ordering data

Version	PCB plug-in connector, female plug, 3.50 mm, Number of poles: 8, 180°, PUSH IN with actuator, Clamping range, max. : 1.5 mm <sup>2</sup> , Box
Order No.	<a href="#">2711040000</a>
Type	B2CF 3.50/08/180LR SN BK BX SO
GTIN (EAN)	4050118747577
Qty.	84 items
Product data	IEC: 320 V / 13.4 A / 0.14 - 1.5 mm <sup>2</sup> UL: 300 V / 9.5 A / AWG 30 - AWG 16
Packaging	Box

## B2CF 3.50/08/180LR SN BK BX SO

Weidmüller Interface GmbH & Co. KG

Klingenbergstraße 26  
D-32758 Detmold  
Germany

www.weidmueller.com

## Technical data

### Dimensions and weights

Depth	29.9 mm	Depth (inches)	1.1772 inch
Height	17.25 mm	Height (inches)	0.6791 inch
Width	20.9 mm	Width (inches)	0.8228 inch
Net weight	5.93 g		

### Environmental Product Compliance

RoHS Compliance Status	Compliant without exemption		
REACH SVHC	No SVHC above 0.1 wt%		
Product Carbon Footprint	Cradle to gate	0.140 kg CO <sub>2</sub> eq.	

### System Parameters

Product family	OMNIMATE Signal - series B2C/S2C 3.50 - 2-row	Type of connection	Field connection
Wire connection method	PUSH IN with actuator	Pitch in mm (P)	3.50 mm
Pitch in inches (P)	0.138 "	Conductor outlet direction	180°
Number of poles	8	L1 in mm	10.50 mm
L1 in inches	0.413 "	Number of rows	1
Pin series quantity	2	Rated cross-section	15 mm <sup>2</sup>
Touch-safe protection acc. to DIN VDE 57 106	Safe from finger touch	Touch-safe protection acc. to DIN VDE 0470	IP20 plugged
Protection degree	IP20, when fully mounted	Can be coded	Yes
Stripping length	10 mm	Screwdriver blade	0.4 x 2.5
Screwdriver blade standard	DIN 5264	Plugging cycles	25
Plugging force/pole, max.	5 N	Pulling force/pole, max.	5 N

### Material data

Insulating material	PA 66 GF 30	Colour	black
Colour of operational elements	black	Colour chart (similar)	RAL 9011
Insulating material group	II	Comparative Tracking Index (CTI)	≥ 600
Insulation resistance	≥ 108 Ω	Moisture Level (MSL)	
UL 94 flammability rating	V-0	Contact material	Cu-alloy
Contact surface	tinned	Layer structure of plug contact	2...5 µm Sn hot-dip tinned
Storage temperature, min.	-40 °C	Storage temperature, max.	70 °C
Operating temperature, min.	-50 °C	Operating temperature, max.	120 °C
Temperature range, installation, min.	-40 °C	Temperature range, installation, max.	120 °C

### Conductors suitable for connection

Clamping range, min.	0.14 mm <sup>2</sup>
Clamping range, max.	1.5 mm <sup>2</sup>
Wire connection cross section AWG, min.	AWG 30
Wire connection cross section AWG, max.	AWG 16
Solid, min. H05(07) V-U	0.14 mm <sup>2</sup>
Solid, max. H05(07) V-U	1.5 mm <sup>2</sup>
Flexible, min. H05(07) V-K	0.14 mm <sup>2</sup>
Flexible, max. H05(07) V-K	1.5 mm <sup>2</sup>
w. plastic collar ferrule, DIN 46228 pt 4, min.	0.14 mm <sup>2</sup>
w. plastic collar ferrule, DIN 46228 pt 4, max.	1 mm <sup>2</sup>

## B2CF 3.50/08/180LR SN BK BX SO

**Weidmüller Interface GmbH & Co. KG**

Klingenbergstraße 26  
D-32758 Detmold  
Germany

www.weidmueller.com

## Technical data

w. wire end ferrule, DIN 46228 pt 1, min. 0.14 mm<sup>2</sup>

w. wire end ferrule, DIN 46228 pt 1, max. 1.5 mm<sup>2</sup>

Clampable conductor	Cross-section for conductor connection	nominal	0.14 mm <sup>2</sup>
wire end ferrule	Stripping length	nominal	10 mm
		Recommended wire-end ferrule	<a href="#">H0.14/12 GR SV</a>
Cross-section for conductor connection	nominal	0.25 mm <sup>2</sup>	
		wire end ferrule	Stripping length
Recommended wire-end ferrule	<a href="#">H0.25/12 HBL SV</a>		
Cross-section for conductor connection	nominal	0.34 mm <sup>2</sup>	
		wire end ferrule	Stripping length
Recommended wire-end ferrule	<a href="#">H0.34/12 TK SV</a>		
Cross-section for conductor connection	nominal	0.5 mm <sup>2</sup>	
		wire end ferrule	Stripping length
Recommended wire-end ferrule	<a href="#">H0.5/16 OR SV</a>		
Stripping length	nominal	10 mm	
		Recommended wire-end ferrule	<a href="#">H0.5/10</a>
Cross-section for conductor connection	nominal	0.75 mm <sup>2</sup>	
		wire end ferrule	Stripping length
Recommended wire-end ferrule	<a href="#">H0.75/16 W SV</a>		
Stripping length	nominal	10 mm	
		Recommended wire-end ferrule	<a href="#">H0.75/10</a>
Cross-section for conductor connection	nominal	1	
		wire end ferrule	Stripping length
Recommended wire-end ferrule	<a href="#">H1.0/16 GE SV</a>		
Stripping length	nominal	10 mm	
		Recommended wire-end ferrule	<a href="#">H1.0/10</a>
Cross-section for conductor connection	nominal	1.5 mm <sup>2</sup>	
		wire end ferrule	Stripping length
Recommended wire-end ferrule	<a href="#">H1.5/10</a>		

Reference text The outside diameter of the plastic collar should not be larger than the pitch (P), Length of ferrules is to be chosen depending on the product and the rated voltage.

### Rated data acc. to IEC

tested acc. to standard	IEC 60664-1, IEC 61984	Rated current, min. number of poles (Tu=20°C)	13.4 A
Rated current, max. number of poles (Tu=20°C)	10 A	Rated current, min. number of poles (Tu=40°C)	12 A
Rated current, max. number of poles (Tu=40°C)	9 A	Rated voltage for surge voltage class / pollution degree II/2	320 V
Rated voltage for surge voltage class / pollution degree III/2	160 V	Rated voltage for surge voltage class / pollution degree III/3	160 V
Rated impulse voltage for surge voltage class/ pollution degree II/2	2.5 kV	Rated impulse voltage for surge voltage class/ pollution degree III/2	2.5 kV
Rated impulse voltage for surge voltage class/ contamination degree III/3	2.5 kV	Short-time withstand current resistance	3 x 1s with 80 A

**B2CF 3.50/08/180LR SN BK BX SO**

**Weidmüller Interface GmbH & Co. KG**  
 Klingenbergstraße 26  
 D-32758 Detmold  
 Germany

www.weidmueller.com

**Technical data**

**Rated data acc. to CSA**

Rated voltage (Use group B / CSA)	300 V	Rated voltage (Use group C / CSA)	50 V
Rated voltage (Use group D / CSA)	300 V	Rated current (Use group B / CSA)	9.5 A
Rated current (Use group C / CSA)	9.5 A	Rated current (Use group D / CSA)	9.5 A
Wire cross-section, AWG, min.	AWG 30	Wire cross-section, AWG, max.	AWG 16

**Rated data acc. to UL 1059**

Rated voltage (Use group B / UL 1059)	300 V	Rated voltage (Use group C / UL 1059)	50 V
Rated voltage (Use group D / UL 1059)	300 V	Rated current (Use group B / UL 1059)	9.5 A
Rated current (Use group C / UL 1059)	9.5 A	Rated current (Use group D / UL 1059)	9.5 A
Wire cross-section, AWG, min.	AWG 30	Wire cross-section, AWG, max.	AWG 16

**Packing**

Packaging	Box	VPE length	351.00 mm
VPE width	138.00 mm	VPE height	42.00 mm

**Type tests**

Test: Durability of markings	Standard	IEC 61984 section 6.2 and 7.3.2 / 10.11 taking pattern from IEC 60068-2-70 / 12.95		
	Test	mark of origin, type identification, pitch, type of material, date clock, approval marking UL, approval marking cULus		
	Evaluation	available		
	Test	durability		
	Evaluation	passed		
Test: Misengagement (Non-interchangeability)	Standard	IEC 61984 section 6.3 and 6.9.1 / 10.11, IEC 60512-13-5 / 02.06		
	Test	180° turned without coding elements		
	Evaluation	passed		
	Test	180° turned with coding elements		
	Evaluation	passed		
	Test	visual examination		
	Evaluation	passed		
Test: Clampable cross section	Standard	IEC 60999-1 section 7 and 9.1 / 11.99, IEC 60947-1 section 8.2.4.5.1 / 03.11		
	Conductor type	Type of conductor and conductor cross-section	solid 0.14 mm <sup>2</sup>	
		Type of conductor and conductor cross-section	stranded 0.14 mm <sup>2</sup>	
		Type of conductor and conductor cross-section	solid 1.5 mm <sup>2</sup>	
		Type of conductor and conductor cross-section	stranded 1.5 mm <sup>2</sup>	
		Type of conductor and conductor cross-section	AWG 26/1	
		Type of conductor and conductor cross-section	AWG 26/19	
		Type of conductor and conductor cross-section	AWG 16/1	

**B2CF 3.50/08/180LR SN BK BX SO**

**Weidmüller Interface GmbH & Co. KG**  
 Klingenbergstraße 26  
 D-32758 Detmold  
 Germany

www.weidmueller.com

**Technical data**

		Type of conductor and conductor cross-section	AWG 16/19	
Test for damage to and accidental loosening of conductors	Evaluation	passed		
	Standard	IEC 60999-1 section 9.4 / 11.99		
	Requirement	0.2 kg		
	Conductor type	Type of conductor and conductor cross-section	AWG 26/1	
		Type of conductor and conductor cross-section	AWG 26/19	
	Evaluation	passed		
	Requirement	0.3 kg		
	Conductor type	Type of conductor and conductor cross-section	H05V-U0.75	
		Type of conductor and conductor cross-section	H05V-K0.75	
	Evaluation	passed		
	Requirement	0.4 kg		
	Conductor type	Type of conductor and conductor cross-section	H07V-U1.5	
Type of conductor and conductor cross-section		H07V-K1.5		
Type of conductor and conductor cross-section		AWG 16/1		
Type of conductor and conductor cross-section		AWG 16/19		
Evaluation	passed			
Pull-out test	Standard	IEC 60999-1 section 9.5 / 11.99		
	Requirement	≥10 N		
	Conductor type	Type of conductor and conductor cross-section	AWG 26/1	
		Type of conductor and conductor cross-section	AWG 26/19	
	Evaluation	passed		
	Requirement	≥20 N		
	Conductor type	Type of conductor and conductor cross-section	H05V-U0.75	
		Type of conductor and conductor cross-section	H05V-K0.75	
	Evaluation	passed		
	Requirement	≥40 N		
	Conductor type	Type of conductor and conductor cross-section	H07V-U1.5	
		Type of conductor and conductor cross-section	H07V-K1.5	
Type of conductor and conductor cross-section		AWG 16/1		

## B2CF 3.50/08/180LR SN BK BX SO

**Weidmüller Interface GmbH & Co. KG**  
 Klingenbergstraße 26  
 D-32758 Detmold  
 Germany

www.weidmueller.com

## Technical data

	Type of conductor and conductor cross-section	AWG 16/19
Evaluation	passed	

### Important note

**IPC conformity** Conformity: The products are developed, manufactured and delivered according international recognized standards and norms and comply with the assured properties in the data sheet resp. fulfill decorative properties in accordance with IPC-A-610 "Class 2". Further claims on the products can be evaluated on request.

- Notes**
- Additional variants on request
  - Gold-plated contact surfaces on request
  - Rated current related to rated cross-section & min. No. of poles.
  - Crimp shape A for wire-end ferrules with crimping tools PZ 1,5 (order no. 9005990000) or PZ 6/5 (order no. 9011460000) for larger wire cross-sections recommended.
  - P on drawing = pitch
  - Rated data refer only to the component itself. Clearance and creepage distances to other components are to be designed in accordance with the relevant application standards.
  - Max. outer diameter of the conductor 2.6 mm
  - In accordance with IEC 61984, OMNIMATE-connectors are connectors without breaking capacity (COC). During designated use, connectors are not allowed to be engaged or disengaged when live or under load
  - Long term storage of the product with average temperature of 50 °C and maximum humidity 70%, 36 months

### Classifications

ETIM 8.0	EC002638	ETIM 9.0	EC002638
ETIM 10.0	EC002638	ECLASS 14.0	27-46-02-02
ECLASS 15.0	27-46-02-02		

Dimensional drawing

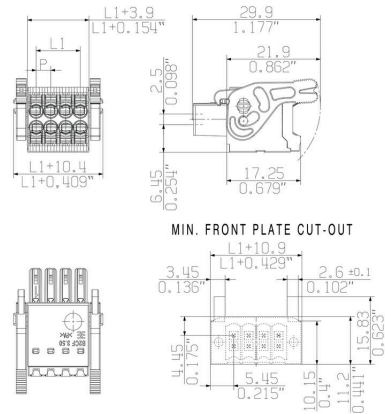

Graph

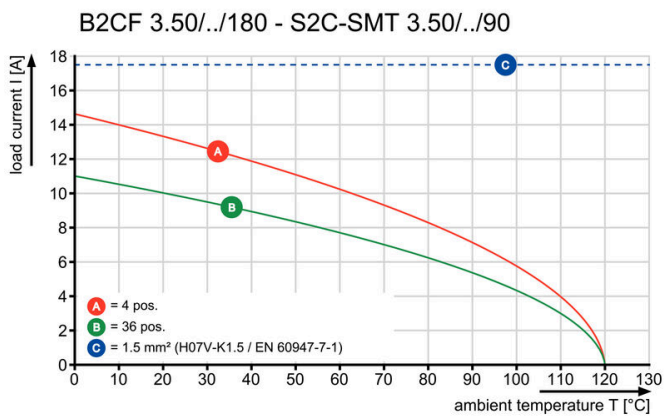

Product benefits

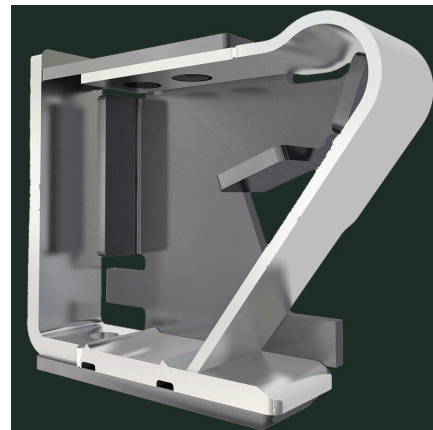

Solid PUSH IN contactSafe and durable

**Product benefits**

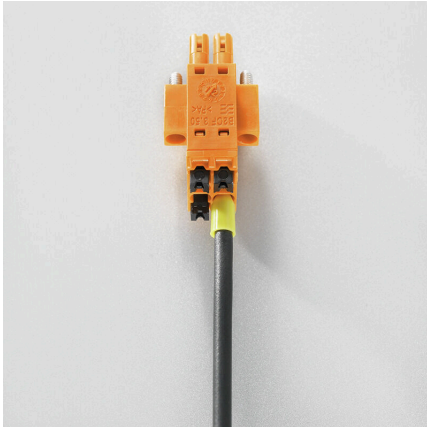

Large connection cross-section  
Up to 1.5 mm possible with ease

**Product benefits**

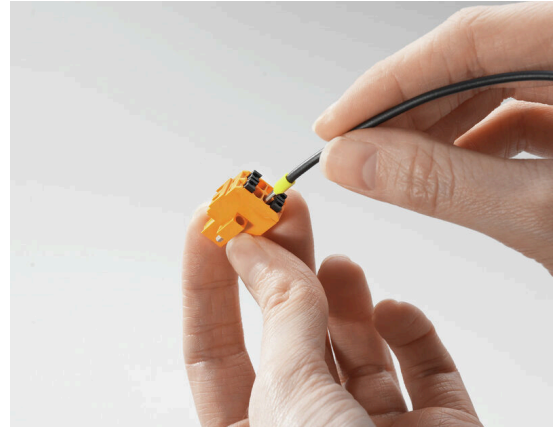

Fast PUSH IN connection  
Tool-free and touch-safe

**Example of use**

