

FP ENC BSBS 67 1M

Weidmüller Interface GmbH & Co. KG
Klingenbergstraße 26
D-32758 Detmold
Germany

www.weidmueller.com

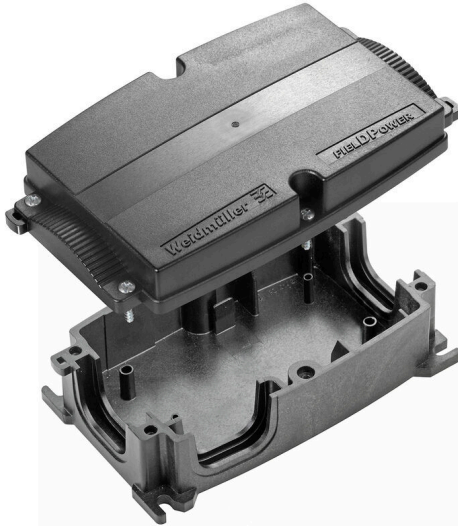

The FieldPower® housings are highly robust and meet the highest UL flammability class 5 VA.

- The "TS 35 PT6" mounting rail module and PT6 contact unit are easy to snap on.
- Hinged seals allow pre-assembled plug cables to also be used.
- The high cover versions enable the device to be installed.

For cable seals consult accessories.

General ordering data

Version	FieldPower® enclosures, 181 mm, 104 mm, 67 mm, IP65, in complete state, glass-fibre reinforced polycarbonate, black
Order No.	2703910000
Type	FP ENC BSBS 67 1M
GTIN (EAN)	4064675266679
Qty.	1 items

FP ENC BSBS 67 1M

Weidmüller Interface GmbH & Co. KG
 Klingenbergstraße 26
 D-32758 Detmold
 Germany

www.weidmueller.com

Technical data

Approvals

Approvals



ROHS Conform
 UL File Number Search [UL Website](#)
 Certificate no. (cULus) E256877

Dimensions and weights

Depth	67 mm	Depth (inches)	2.6378 inch
Height	181 mm	Height (inches)	7.126 inch
Width	104 mm	Width (inches)	4.0945 inch
Net weight	343.87 g		

Temperatures

Storage temperature	-40 °C...85 °C	Operating temperature	-40 °C...85 °C
---------------------	----------------	-----------------------	----------------

Environmental Product Compliance

RoHS Compliance Status Compliant without exemption
 REACH SVHC Potassium perfluorobutane sulfonate 29420-49-3
 SCIP 5f19cd84-8946-4797-9386-3ac323b95c10

General data

Basic material	Polycarbonate, GRP	Insulating material	GF 10
Enclosure material	glass-fibre reinforced polycarbonate	Silicone	No
Colour	black	Protection degree	IP65, in complete state
UL 94 flammability rating	5VA	Torque for lid screws	2 Nm
Lid attachment	TX20 screws	lockable	No
Type of mounting	Screw mounting, Fixing lugs	Installation advice	Lid screws included

Classifications

ETIM 8.0	EC000261	ETIM 9.0	EC000261
ETIM 10.0	EC000261	ECLASS 14.0	27-18-01-01
ECLASS 15.0	27-18-01-01		

FP ENC BSBS 67 1M

Weidmüller Interface GmbH & Co. KG
Klingenbergstraße 26
D-32758 Detmold
Germany

Drawings

www.weidmueller.com

Drilling template

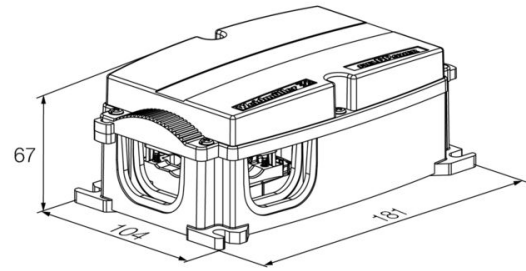
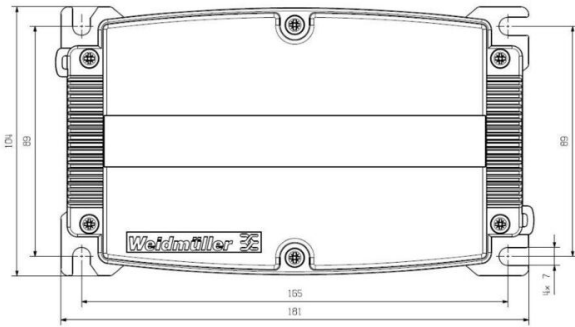

FP ENC BSBS 67 1M

Weidmüller Interface GmbH & Co. KG
 Klingenbergstraße 26
 D-32758 Detmold
 Germany

www.weidmueller.com

Accessories

Seals



Intelligent cabling solutions can save you valuable time and money.

The FieldPower® modular system contains the right solution for every cabling task.

Foldable seals for the use of pre-assembled cables
 Seals available with M16 and M20 connection thread
 Integration of operating and signalling devices into the seal possible

General ordering data

Type	DG D0 PT6	Version
Order No.	4323240000	Field Power® sealing insert, Blank seal, IP65, with corresponding enclosure, EPDM
GTIN (EAN)	4032248641246	
Qty.	10 ST	
Type	DG M16 PT6	Version
Order No.	2545540000	Field Power® sealing insert, Seal with connection thread, IP65, with corresponding enclosure, EPDM
GTIN (EAN)	4050118555523	
Qty.	1 ST	
Type	DG M20 PT6	Version
Order No.	2545550000	Field Power® sealing insert, Seal with connection thread, IP65, with corresponding enclosure, EPDM
GTIN (EAN)	4050118555530	
Qty.	1 ST	
Type	RKDG 2XD8.5 WG PT6	Version
Order No.	1114530000	Field Power® sealing insert, Seal, IP54, with corresponding enclosure, EPDM
GTIN (EAN)	4032248892624	
Qty.	10 ST	
Type	RKDG D11 PT6	Version
Order No.	4323210000	Field Power® sealing insert, Foldable seal, IP65 with corresponding housing, IP65, with corresponding enclosure, EPDM
GTIN (EAN)	4032248641215	
Qty.	10 ST	
Type	RKDG D13 PT6	Version
Order No.	4323230000	Field Power® sealing insert, Foldable seal, IP65 with corresponding housing, IP65, with corresponding enclosure, EPDM
GTIN (EAN)	4032248641239	
Qty.	10 ST	
Type	RKDG D15 PT6	Version
Order No.	4323220000	Field Power® sealing insert, Foldable seal, IP65 with corresponding housing, IP65, with corresponding enclosure, EPDM
GTIN (EAN)	4032248641222	
Qty.	10 ST	
Type	RKDG D17 PT6	Version
Order No.	4324010000	Field Power® sealing insert, Foldable seal, IP65 with corresponding housing, IP65, with corresponding enclosure, EPDM
GTIN (EAN)	4032248641284	
Qty.	10 ST	
Type	RKDG D18 WG PT6	Version
Order No.	2491870000	Field Power® sealing insert, Seal, IP54, with corresponding enclosure, EPDM
GTIN (EAN)	4050118501537	
Qty.	10 ST	
Type	RKDG D9 PT6	Version
Order No.	4329610000	Field Power® sealing insert, Foldable seal, IP65 with corresponding housing, IP65, with corresponding enclosure, EPDM
GTIN (EAN)	4032248668687	
Qty.	10 ST	

FP ENC BSBS 67 1M

Weidmüller Interface GmbH & Co. KG
 Klingenbergstraße 26
 D-32758 Detmold
 Germany

www.weidmueller.com

Accessories

Adapters

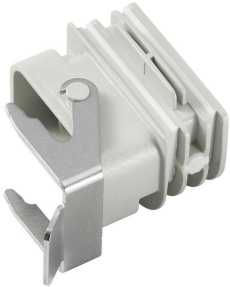

HQ adapter for FieldPower®
 Tool-free installation like a FieldPower cable seal
 Suitable for the HQ 4/2, HQ 8 and HQ 17 plug-in connector inserts
 Optionally with lockable protective cover (protection against being switched on again, in accordance with EN 60204-1)

General ordering data

Type	BG ARGH HQP ALU PT6	Version
Order No.	1532200000	Adapter, Field Power® sealing insert, HQ adapter, IP65, with corresponding enclosure, Polycarbonate, glass fibre reinforced,
GTIN (EAN)	4050118337433	lockable: No
Qty.	1 ST	
Type	BG ARGH HQP ALU PT6 CS	Version
Order No.	1532210000	Adapter, Field Power® sealing insert, HQ adapter, IP65, with corresponding enclosure, Polycarbonate, glass fibre reinforced,
GTIN (EAN)	4050118337600	lockable: Yes
Qty.	1 ST	

AC/DC

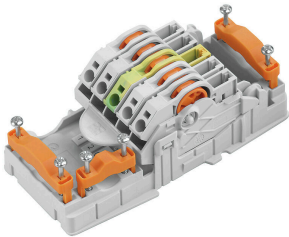

Power distribution using uncut cables with cross-sections from 1.5 to 6 mm².
 Power supply / T-branch tap via PUSH IN connection (0.5 to 10 mm²) and/or plug-in connection (0.5 to 4 mm²).
 Coloured markings provide clear assignment of wires.

- Power supply
- Power distribution
- Power branching

General ordering data

Type	PT6 230/BUS	Version
Order No.	1269960000	FieldPower® contact element, AC/DC, IP20, Insulation displacement connection (IDC), PUSH IN, Number of poles : 5
GTIN (EAN)	4050118058239	
Qty.	1 ST	

AC

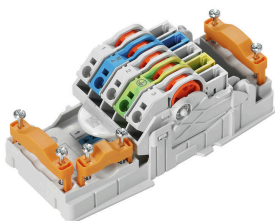

Power distribution using uncut cables with cross-sections from 1.5 to 6 mm².
 Power supply / T-branch tap via PUSH IN connection (0.5 to 10 mm²) and/or plug-in connection (0.5 to 4 mm²).
 Coloured markings provide clear assignment of wires.

- Power supply
- Power distribution
- Power branching

FP ENC BSBS 67 1M

Weidmüller Interface GmbH & Co. KG
 Klingenbergstraße 26
 D-32758 Detmold
 Germany

www.weidmueller.com

Accessories

General ordering data

Type	PT6	Version	
Order No.	1957620000	FieldPower® contact element, AC, IP20, Insulation displacement connection (IDC), PUSH IN, Number of poles : 5	
GTIN (EAN)	4032248642489		
Qty.	1 ST		

AC/DC

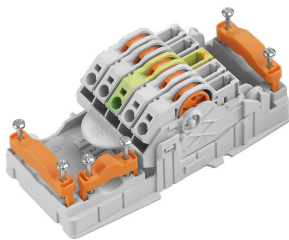

Power distribution using uncut cables with cross-sections from 1.5 to 6 mm².

Power supply / T-branch tap via PUSH IN connection (0.5 to 10 mm²) and/or plug-in connection (0.5 to 4 mm²). Coloured markings provide clear assignment of wires.

- Power supply
- Power distribution
- Power branching

General ordering data

Type	PT6 DC 1/2/PE/3/4	Version	
Order No.	1534930000	FieldPower® contact element, DC, IP20, Insulation displacement connection (IDC), PUSH IN, Number of poles : 5	
GTIN (EAN)	4050118338775		
Qty.	1 ST		

DC

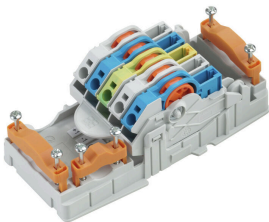

Power distribution using uncut cables with cross-sections from 1.5 to 6 mm².

Power supply / T-branch tap via PUSH IN connection (0.5 to 10 mm²) and/or plug-in connection (0.5 to 4 mm²). Coloured markings provide clear assignment of wires.

- Power supply
- Power distribution
- Power branching

General ordering data

Type	PT6 DC	Version	
Order No.	1126840000	FieldPower® contact element, DC, IP20, Insulation displacement connection (IDC), PUSH IN, Number of poles : 5	
GTIN (EAN)	4032248908462		
Qty.	1 ST		

FP ENC BSBS 67 1M

Weidmüller Interface GmbH & Co. KG
 Klingenbergstraße 26
 D-32758 Detmold
 Germany

www.weidmueller.com

Accessories

Terminal rails for lower parts of enclosure



Extensive range of accessories for the FieldPower® boxes.
 Cable seals, terminal rails, locking elements and much more.

General ordering data

Type	TS 35 PT6	Version	
Order No.	1170690000		Field Power® terminal rail, Steel, galvanized, 54 mm, for base part
GTIN (EAN)	4032248962532		
Qty.	10 ST		

DMS PRO



Weidmüller torque screwdrivers have an ergonomic design and are therefore ideal for use with one hand. They can be used without causing fatigue in all installation positions. Apart from that, they incorporate an automatic torque limiter and have a good reproducibility accuracy.

General ordering data

Type	DMS PRO	Version	
Order No.	1479120000		Mounting tool
GTIN (EAN)	4050118287011		
Qty.	1 ST		

Accessories

Bits E6,3 - Torx®



The Weidmüller bits are standard bits which are highly popular with users thanks to their good quality, large range and efficiency. The computer-controlled hardening method enables Weidmüller to guarantee a consistently high standard of quality.

The high-quality raw materials used make it possible to reach torques far higher than any of those specified in the relevant DIN standards:

- DIN 526 1 for PH/PZ bits,
- DIN 5263 for slotted bits,
- Camcar standard for TORX bits

That means a long life at high torques and hence ideal conditions for standard situations.

The benefits:

- Suitable for all types of screws. Because of their excellent hardness values of 59-61 HRC, they are suitable for use with both manual and power tools.
- Good wearing resistance and thus a long life expectancy.
- Optimum fit in all DIN screws means low wear and optimum torque transmission.
- Manufactured to meet professional quality criteria according to relevant ISO standards with a consistently high standard of quality.

General ordering data

Type	BIT E6,3 T20 X 70	Version	
Order No.	2749010000	Screwdriver insert	
GTIN (EAN)	4050118895308		
Qty.	5 ST		

Seals

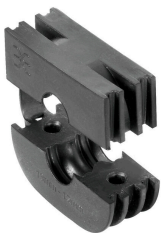

Intelligent cabling solutions can save you valuable time and money.

The FieldPower® modular system contains the right solution for every cabling task.

Foldable seals for the use of pre-assembled cables

Seals available with M16 and M20 connection thread
Integration of operating and signalling devices into the seal possible

General ordering data

Type	RKDG D24 WG PT6	Version	
Order No.	1069060000	Field Power® sealing insert, Seal, IP54, with corresponding enclosure, EPDM	
GTIN (EAN)	4032248827053		
Qty.	10 ST		