

AIO21 1.5 SI DL OR**Weidmüller Interface GmbH & Co. KG**

Klingenbergstraße 26

D-32758 Detmold

Germany

www.weidmueller.com

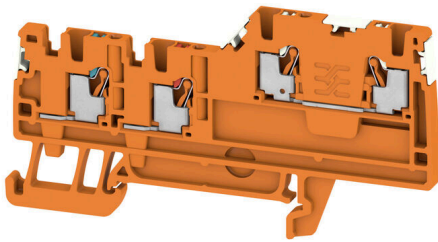

With the current levels of automation, there are more and more sensors monitoring the production process. This increases the number of signals to be combined and structured. Given the restricted space in the panel, this can become a real challenge. Our application-specific initiator/actuator terminal blocks (AIO) are specially designed for the signal wiring requirements posed by automation now and into the future. You can benefit from tailored, really compact solutions for the structured wiring of initiator and actuator signals with the input and output modules of a programmable logic controller (PLC).

General ordering data

Version	Initiator/actuator terminal, PUSH IN, 1.5 mm ² , 250 V, 13.5 A, orange
Order No.	2675630000
Type	AIO21 1.5 SI DL OR
GTIN (EAN)	4050118733952
Qty.	100 items

AIO21 1.5 SI DL OR

Weidmüller Interface GmbH & Co. KG

Klingenbergstraße 26

D-32758 Detmold

Germany

www.weidmueller.com

Technical data

Approvals

Approvals



ROHS Conform

UL File Number Search [UL Website](#)

Certificate No. (cURus) E60693

Dimensions and weights

Depth	42 mm	Depth (inches)	1.6535 inch
Depth including DIN rail	43 mm	Height	80 mm
Height (inches)	3.1496 inch	Width	3.5 mm
Width (inches)	0.1378 inch	Net weight	6.94 g

Temperatures

Storage temperature	-25 °C...55 °C	Ambient temperature	-5 °C...40 °C
Continuous operating temp., min.	-60 °C	Continuous operating temp., max.	130 °C

Environmental Product Compliance

RoHS Compliance Status	Compliant without exemption
REACH SVHC	No SVHC above 0.1 wt%

Material data

Basic material	Wemid	Colour	orange
UL 94 flammability rating	V-0		

Rating data IECEx/ATEX

Certificate No. (ATEX)	TUEV17ATEX8031U	Certificate No. (IECEX)	IECEXTUR17.0016U
Max. voltage (ATEX)	220 V	Current (ATEX)	12 A
Wire cross section max. (ATEX)	1.5 mm ²	Max. voltage (IECEX)	220 V
Current (IECEX)	12 A	Wire cross section max. (IECEX)	1.5 mm ²

System specifications

End cover plate required	Yes	Number of potentials	3
Number of levels	2	Number of clamping points per level	2
Levels cross-connected internally	No	PE connection	No
Mounting rail	TS 35		

Additional technical data

Open sides	right	Explosion-tested version	Yes
Type of mounting	TS 35		

CSA rating data

Wire cross section max. (CSA)	14 AWG	Certificate No. (CSA)	200039-70089609
Voltage size D (CSA)	150 V	Current size D (CSA)	13 A
Wire cross section min. (CSA)	26 AWG		

AIO21 1.5 SI DL OR

Weidmüller Interface GmbH & Co. KG
 Klingenbergstraße 26
 D-32758 Detmold
 Germany

www.weidmueller.com

Technical data

Conductors for clamping (rated connection)

Gauge to IEC 60947-1	A1		
Wire connection cross section AWG, max.	AWG 14		
Connection direction	top		
Stripping length	8 mm		
Type of connection 2	PUSH IN		
Type of connection	PUSH IN		
Number of connections	4		
Clamping range, max.	1.5 mm ²		
Clamping range, min.	0.14 mm ²		
Blade size	0.4 x 2.0 mm		
Wire connection cross section AWG, min.	AWG 26		
Wire connection cross-section, finely stranded with wire-end ferrules DIN 46228/4, max.	1.5 mm ²		
Wire connection cross-section, finely stranded with wire-end ferrules DIN 46228/4, min.	0.14 mm ²		
Wire connection cross-section, finely stranded with wire-end ferrules DIN 46228/1, max.	1.5 mm ²		
Wire connection cross-section, finely stranded with wire-end ferrules DIN 46228/1, min.	0.14 mm ²		
Wire connection cross section, finely stranded, max.	1.5 mm ²		
Wire connection cross section, finely stranded, min.	0.14 mm ²		
Connection cross-section, stranded, max.	1.5 mm ²		
Connection cross-section, stranded, min.	0.14 mm ²		
Wire connection cross-section, solid core, max.	1.5 mm ²		
Wire connection cross-section, solid core, min.	0.14 mm ²		
Connection cross-section, finely stranded, min.	0.14 mm ²		
Tube length for wire-end ferrule with plastic collar DIN 46228/4	Tube length	min.	6 mm
		max.	8 mm
	Cross-section for conductor connection	min.	0.14 mm ²
		max.	0.75 mm ²
Tube length for wire-end ferrule without plastic collar DIN 46228/1	Tube length	min.	5 mm
		Cross-section for conductor connection	nominal
	Tube length	nominal	6 mm
		Cross-section for conductor connection	min.
		max.	1 mm ²
	Tube length	nominal	10 mm
Cross-section for conductor connection	nominal	1.5 mm ²	

General

Wire connection cross section AWG, max.	AWG 14	Wire connection cross section AWG, min.	AWG 26
Standards	In accordance with IEC 60947-7-1	Mounting rail	TS 35

AIO21 1.5 SI DL OR

Weidmüller Interface GmbH & Co. KG
 Klingenbergstraße 26
 D-32758 Detmold
 Germany

www.weidmueller.com

Technical data

Rating data

Rated cross-section	1.5 mm ²	Rated voltage	250 V
Rated DC voltage	250 V	Nominal current	13.5 A
Current at maximum wires	13.5 A	Standards	In accordance with IEC 60947-7-1
Volume resistance according to IEC 60947-7-x	1.83 mΩ	Rated impulse withstand voltage	4 kV
Power loss in accordance with IEC 60947-7-x	0.56 W	Surge voltage category	III
Pollution severity	3		

UL rating data

Conductor size Factory wiring max. (cURus)	14 AWG	Voltage size D (cURus)	150 V
Certificate No. (cURus)	E60693	Conductor size Field wiring min. (cURus)	26 AWG
Conductor size Factory wiring min. (cURus)	26 AWG	Current size D (cURus)	13 A
Conductor size Field wiring max. (cURus)	14 AWG		

Classifications

ETIM 8.0	EC000900	ETIM 9.0	EC000900
ETIM 10.0	EC000900	ECLASS 14.0	27-25-01-12
ECLASS 15.0	27-25-01-12		

Drawings

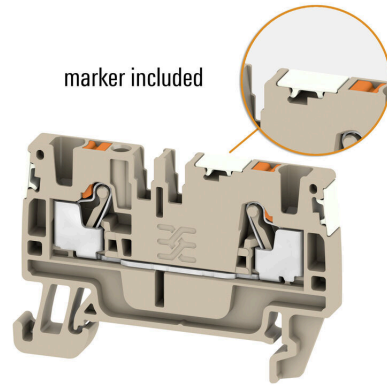
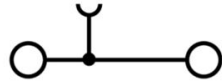
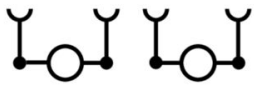

AIO21 1.5 SI DL OR

Weidmüller Interface GmbH & Co. KG
 Klingenbergstraße 26
 D-32758 Detmold
 Germany

Accessories

www.weidmueller.com

Cross-connections



The distribution or multiplication of a potential to adjoining terminal blocks is realized via a cross-connection. Additional wiring effort can be easily avoided. Even if the poles are broken out, contact reliability in the terminal blocks is still ensured. Our portfolio offers pluggable and screwable cross-connection systems for modular terminal blocks.

General ordering data

Type	ZQV 1.5N/10	Version
Order No.	1985580000	Cross-connector (terminal), Plugged, orange, 17.5 A, Number of poles: 10, Pitch in mm (P): 3.50, Insulated: Yes, Width: 33.5 mm
GTIN (EAN)	4050118370416	
Qty.	20 ST	
Type	ZQV 1.5N/10 RD	Version
Order No.	1985800000	Cross-connector (terminal), Plugged, red, 17.5 A, Number of poles: 10, Pitch in mm (P): 3.50, Insulated: Yes, Width: 33.5 mm
GTIN (EAN)	4050118370393	
Qty.	20 ST	
Type	ZQV 1.5N/10 BL	Version
Order No.	1985680000	Cross-connector (terminal), Plugged, blue, 17.5 A, Number of poles: 10, Pitch in mm (P): 3.50, Insulated: Yes, Width: 33.5 mm
GTIN (EAN)	4050118370539	
Qty.	20 ST	
Type	ZQV 1.5N/2	Version
Order No.	1985410000	Cross-connector (terminal), Plugged, orange, 17.5 A, Number of poles: 2, Pitch in mm (P): 3.50, Insulated: Yes, Width: 5.5 mm
GTIN (EAN)	4050118369861	
Qty.	60 ST	
Type	ZQV 1.5N/2 BL	Version
Order No.	1985530000	Cross-connector (terminal), Plugged, blue, 17.5 A, Number of poles: 2, Pitch in mm (P): 3.50, Insulated: Yes, Width: 5.5 mm
GTIN (EAN)	4050118370423	
Qty.	60 ST	
Type	ZQV 1.5N/2 RD	Version
Order No.	1985650000	Cross-connector (terminal), Plugged, red, 17.5 A, Number of poles: 2, Pitch in mm (P): 3.50, Insulated: Yes, Width: 5.5 mm
GTIN (EAN)	4050118370324	
Qty.	60 ST	
Type	ZQV 1.5N/20	Version
Order No.	1985600000	Cross-connector (terminal), Plugged, orange, 17.5 A, Number of poles: 20, Pitch in mm (P): 3.50, Insulated: Yes, Width: 70 mm
GTIN (EAN)	4050118370225	
Qty.	20 ST	
Type	ZQV 1.5N/20 BL	Version
Order No.	1985700000	Cross-connector (terminal), Plugged, blue, 17.5 A, Number of poles: 20, Pitch in mm (P): 3.50, Insulated: Yes, Width: 70 mm
GTIN (EAN)	4050118370331	
Qty.	20 ST	
Type	ZQV 1.5N/20 RD	Version
Order No.	1985810000	Cross-connector (terminal), Plugged, red, 17.5 A, Number of poles: 20, Pitch in mm (P): 3.50, Insulated: Yes, Width: 70 mm
GTIN (EAN)	4050118370355	
Qty.	20 ST	
Type	ZQV 1.5N/3	Version
Order No.	1985480000	Cross-connector (terminal), Plugged, orange, 17.5 A, Number of poles: 3, Pitch in mm (P): 3.50, Insulated: Yes, Width: 9 mm
GTIN (EAN)	4050118370096	
Qty.	60 ST	

AIO21 1.5 SI DL OR

Weidmüller Interface GmbH & Co. KG
 Klingenbergstraße 26
 D-32758 Detmold
 Germany

www.weidmueller.com

Accessories

Type	ZQV 1.5N/3 BL	Version
Order No.	1985550000	Cross-connector (terminal), Plugged, blue, 17.5 A, Number of poles: 3,
GTIN (EAN)	4050118370485	Pitch in mm (P): 3.50, Insulated: Yes, Width: 9 mm
Qty.	60 ST	
Type	ZQV 1.5N/3 RD	Version
Order No.	1985670000	Cross-connector (terminal), Plugged, red, 17.5 A, Number of poles: 3,
GTIN (EAN)	4050118370348	Pitch in mm (P): 3.50, Insulated: Yes, Width: 9 mm
Qty.	60 ST	
Type	ZQV 1.5N/4	Version
Order No.	1985490000	Cross-connector (terminal), Plugged, orange, 17.5 A, Number of
GTIN (EAN)	4050118370201	poles: 4, Pitch in mm (P): 3.50, Insulated: Yes, Width: 12.5 mm
Qty.	60 ST	
Type	ZQV 1.5N/4 BL	Version
Order No.	1985570000	Cross-connector (terminal), Plugged, blue, 17.5 A, Number of poles: 4,
GTIN (EAN)	4050118370317	Pitch in mm (P): 3.50, Insulated: Yes, Width: 12.5 mm
Qty.	60 ST	
Type	ZQV 1.5N/4 RD	Version
Order No.	1985690000	Cross-connector (terminal), Plugged, red, 17.5 A, Number of poles: 4,
GTIN (EAN)	4050118370515	Pitch in mm (P): 3.50, Insulated: Yes, Width: 12.5 mm
Qty.	60 ST	
Type	ZQV 1.5N/5 BL	Version
Order No.	1985590000	Cross-connector (terminal), Plugged, blue, 17.5 A, Number of poles: 5,
GTIN (EAN)	4050118370430	Pitch in mm (P): 3.50, Insulated: Yes, Width: 16 mm
Qty.	20 ST	
Type	ZQV 1.5N/5	Version
Order No.	1985500000	Cross-connector (terminal), Plugged, orange, 17.5 A, Number of
GTIN (EAN)	4050118369991	poles: 5, Pitch in mm (P): 3.50, Insulated: Yes, Width: 16 mm
Qty.	20 ST	
Type	ZQV 1.5N/5 RD	Version
Order No.	1985710000	Cross-connector (terminal), Plugged, red, 17.5 A, Number of poles: 5,
GTIN (EAN)	4050118370256	Pitch in mm (P): 3.50, Insulated: Yes, Width: 16 mm
Qty.	20 ST	
Type	ZQV 1.5N/50	Version
Order No.	1985620000	Cross-connector (terminal), Plugged, orange, 17.5 A, Number of
GTIN (EAN)	4050118370300	poles: 50, Pitch in mm (P): 3.50, Insulated: Yes, Width: 175 mm
Qty.	5 ST	
Type	ZQV 1.5N/50 BL	Version
Order No.	1985720000	Cross-connector (terminal), Plugged, blue, 17.5 A, Number of poles:
GTIN (EAN)	4050118370546	50, Pitch in mm (P): 3.50, Insulated: Yes, Width: 175 mm
Qty.	5 ST	
Type	ZQV 1.5N/50 RD	Version
Order No.	1985820000	Cross-connector (terminal), Plugged, red, 17.5 A, Number of poles:
GTIN (EAN)	4050118370270	50, Pitch in mm (P): 3.50, Insulated: Yes, Width: 175 mm
Qty.	5 ST	
Type	ZQV 1.5N/6	Version
Order No.	1985510000	Cross-connector (terminal), Plugged, orange, 17.5 A, Number of
GTIN (EAN)	4050118370188	poles: 6, Pitch in mm (P): 3.50, Insulated: Yes, Width: 19.5 mm
Qty.	20 ST	
Type	ZQV 1.5N/6 BL	Version
Order No.	1985610000	Cross-connector (terminal), Plugged, blue, 17.5 A, Number of poles: 6,
GTIN (EAN)	4050118370492	Pitch in mm (P): 3.50, Insulated: Yes, Width: 19.5 mm
Qty.	20 ST	

AIO21 1.5 SI DL OR

Weidmüller Interface GmbH & Co. KG
 Klingenbergstraße 26
 D-32758 Detmold
 Germany

www.weidmueller.com

Accessories

Type	ZQV 1.5N/6 RD	Version
Order No.	1985730000	Cross-connector (terminal), Plugged, red, 17.5 A, Number of poles: 6,
GTIN (EAN)	4050118370454	Pitch in mm (P): 3.50, Insulated: Yes, Width: 19.5 mm
Qty.	20 ST	
Type	ZQV 1.5N/7	Version
Order No.	1985520000	Cross-connector (terminal), Plugged, orange, 17.5 A, Number of
GTIN (EAN)	4050118370195	poles: 7, Pitch in mm (P): 3.50, Insulated: Yes, Width: 23 mm
Qty.	20 ST	
Type	ZQV 1.5N/7 BL	Version
Order No.	1985630000	Cross-connector (terminal), Plugged, blue, 17.5 A, Number of poles: 7,
GTIN (EAN)	4050118370522	Pitch in mm (P): 3.50, Insulated: Yes, Width: 23 mm
Qty.	20 ST	
Type	ZQV 1.5N/7 RD	Version
Order No.	1985750000	Cross-connector (terminal), Plugged, red, 17.5 A, Number of poles: 7,
GTIN (EAN)	4050118370249	Pitch in mm (P): 3.50, Insulated: Yes, Width: 23 mm
Qty.	20 ST	
Type	ZQV 1.5N/8	Version
Order No.	1985540000	Cross-connector (terminal), Plugged, orange, 17.5 A, Number of
GTIN (EAN)	4050118370218	poles: 8, Pitch in mm (P): 3.50, Insulated: Yes, Width: 26.5 mm
Qty.	20 ST	
Type	ZQV 1.5N/8 BL	Version
Order No.	1985640000	Cross-connector (terminal), Plugged, blue, 17.5 A, Number of poles: 8,
GTIN (EAN)	4050118370461	Pitch in mm (P): 3.50, Insulated: Yes, Width: 26.5 mm
Qty.	20 ST	
Type	ZQV 1.5N/8 RD	Version
Order No.	1985770000	Cross-connector (terminal), Plugged, red, 17.5 A, Number of poles: 8,
GTIN (EAN)	4050118370508	Pitch in mm (P): 3.50, Insulated: Yes, Width: 26.5 mm
Qty.	20 ST	
Type	ZQV 1.5N/9	Version
Order No.	1985560000	Cross-connector (terminal), Plugged, orange, 17.5 A, Number of
GTIN (EAN)	4050118370409	poles: 9, Pitch in mm (P): 3.50, Insulated: Yes, Width: 30 mm
Qty.	20 ST	
Type	ZQV 1.5N/9 BL	Version
Order No.	1985660000	Cross-connector (terminal), Plugged, blue, 17.5 A, Number of poles: 9,
GTIN (EAN)	4050118370478	Pitch in mm (P): 3.50, Insulated: Yes, Width: 30 mm
Qty.	20 ST	
Type	ZQV 1.5N/9 RD	Version
Order No.	1985790000	Cross-connector (terminal), Plugged, red, 17.5 A, Number of poles: 9,
GTIN (EAN)	4050118370386	Pitch in mm (P): 3.50, Insulated: Yes, Width: 30 mm
Qty.	20 ST	

Testadapter and testsockets



Test adapters and test plugs are used for the electrical connection between terminal blocks and the test equipment. In this way, an electrical contact can be established in the wired state and measurements can be done easily.

AIO21 1.5 SI DL OR

Weidmüller Interface GmbH & Co. KG
 Klingenbergstraße 26
 D-32758 Detmold
 Germany

www.weidmueller.com

Accessories

General ordering data

Type	ATPG 1.5 MI-R	Version
Order No.	1991880000	Test adapter (terminal), 1.5 mm ² , 250 V, 0.2 A
GTIN (EAN)	4050118376715	
Qty.	50 ST	
Type	ATPG 1.5-10 L	Version
Order No.	1991890000	Test adapter (terminal), 1.5 mm ² , 250 V, 0.2 A
GTIN (EAN)	4050118376647	
Qty.	50 ST	

End plates and partition plates



Partition plates and end plates are essential accessories for terminal blocks. Partition plates provide optical and electrical separation of different potentials and functional groups, increasing safety and ensuring a clear structure inside the control cabinet. End plates close the terminal block row on the sides, protect against contact with live parts, and ensure a clean, stable finish. Both components are precisely matched to the respective Weidmüller terminal block series, contributing to safe, compliant, and professional wiring.

General ordering data

Type	AEP IO21	Version
Order No.	1993580000	A-series, End plate
GTIN (EAN)	4050118378535	
Qty.	50 ST	

End bracket

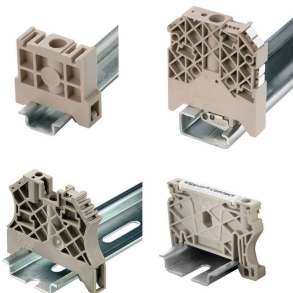

Weidmüller's range of products includes end brackets that guarantee a permanent, reliable mounting on the terminal rail and prevent sliding. Versions with and without screws are available. The end brackets include marking options, also for group markers, and also a test plug holder.

General ordering data

Type	AEB 35 SC/1	Version
Order No.	1991920000	A-series, End bracket
GTIN (EAN)	4050118376722	
Qty.	50 ST	

AIO21 1.5 SI DL OR

Weidmüller Interface GmbH & Co. KG

Klingenbergstraße 26

D-32758 Detmold

Germany

www.weidmueller.com

Accessories

Blank

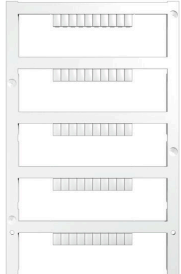

The Dekafix (DEK) marker is the universal marker for all conductor and plug-in connectors as well as for electronic sub-assemblies. The system is ideal for short number sequences and covers a wide range of ready-printed markers.

Strips for fast installation in only one work step. The printing is easy to read, rich in contrast and available in various widths.

- Large range of ready-to-use markers
 - Strips for fast installation
 - Terminal markers, suitable for all Weidmüller cable connectors
 - Available as blank MultiCard or with standard printing
- For custom printing: Please send us a file of our labeling software M-Print PRO or M-Print PRO Online (without installation) for your labeling specifications.

General ordering data

Type	DEK 5/3.5 MC NE GE	Version
Order No.	1369480000	Dekafix, Terminal marker, 5 x 3.5 mm, Pitch in mm (P): 3.50
GTIN (EAN)	4050118171860	Weidmueller, yellow
Qty.	500 ST	
Type	DEK 5/3.5 MC NE WS	Version
Order No.	1755270000	Dekafix, Terminal marker, 5 x 3.5 mm, Pitch in mm (P): 3.50
GTIN (EAN)	4032248017348	Weidmueller, white
Qty.	500 ST	

Custom printing



The Dekafix (DEK) marker is the universal marker for all conductor and plug-in connectors as well as for electronic sub-assemblies. The system is ideal for short number sequences and covers a wide range of ready-printed markers.

Strips for fast installation in only one work step. The printing is easy to read, rich in contrast and available in various widths.

- Large range of ready-to-use markers
 - Strips for fast installation
 - Terminal markers, suitable for all Weidmüller cable connectors
 - Available as blank MultiCard or with standard printing
- For custom printing: Please send us a file of our labeling software M-Print PRO or M-Print PRO Online (without installation) for your labeling specifications.

General ordering data

Type	DEK 5/3.5 MC SDR	Version
Order No.	1767730000	Dekafix, Terminal marker, 5 x 3.5 mm, Pitch in mm (P): 3.50
GTIN (EAN)	4032248102532	Weidmueller, To customer specification
Qty.	100 ST	

AIO21 1.5 SI DL OR

Weidmüller Interface GmbH & Co. KG

Klingenbergstraße 26

D-32758 Detmold

Germany

www.weidmueller.com

Accessories

Blank



The Dekafix (DEK) marker is the universal marker for all conductor and plug-in connectors as well as for electronic sub-assemblies. The system is ideal for short number sequences and covers a wide range of ready-printed markers.

Strips for fast installation in only one work step. The printing is easy to read, rich in contrast and available in various widths.

- Large range of ready-to-use markers
 - Strips for fast installation
 - Terminal markers, suitable for all Weidmüller cable connectors
 - Available as blank MultiCard or with standard printing
- For custom printing: Please send us a file of our labeling software M-Print PRO or M-Print PRO Online (without installation) for your labeling specifications.

General ordering data

Type	DEK 5/3.5 PLUS MC NE WS	Version
Order No.	2003750000	Dekafix, Terminal marker, 5 x 3.5 mm, Pitch in mm (P): 3.50
GTIN (EAN)	4050118424430	Weidmueller, white
Qty.	1600 ST	

Custom printing



The Dekafix (DEK) marker is the universal marker for all conductor and plug-in connectors as well as for electronic sub-assemblies. The system is ideal for short number sequences and covers a wide range of ready-printed markers.

Strips for fast installation in only one work step. The printing is easy to read, rich in contrast and available in various widths.

- Large range of ready-to-use markers
 - Strips for fast installation
 - Terminal markers, suitable for all Weidmüller cable connectors
 - Available as blank MultiCard or with standard printing
- For custom printing: Please send us a file of our labeling software M-Print PRO or M-Print PRO Online (without installation) for your labeling specifications.

General ordering data

Type	DEK 5/3.5 PLUS MC SDR	Version
Order No.	2007790000	Dekafix, Terminal marker, 5 x 3.5 mm, Pitch in mm (P): 3.50
GTIN (EAN)	4050118393347	Weidmueller, To customer specification
Qty.	320 ST	
Type	WS 10/3.5 PLUS MC SDR	Version
Order No.	2007760000	WS, Terminal marker, 10 x 3.5 mm, Pitch in mm (P): 3.50
GTIN (EAN)	4050118393262	Weidmueller, To customer specification
Qty.	192 ST	

AIO21 1.5 SI DL OR

Weidmüller Interface GmbH & Co. KG

Klingenbergstraße 26

D-32758 Detmold

Germany

www.weidmueller.com

Accessories

Blank



WS markers are the perfect match for the W-series connectors. Thanks to their system compatibility, the WS tags can also be used with the I-series and the Z-series. The large marking surfaces do not only permit long character strings but also multi-line text.

WS markers are ideal for labels with long, customised character strings. Thanks to the proven MultiCard format, printing with PrintJet CONNECT oder/or Plotter is possible.

- Can be fitted in strips or individually
- Markers in proven MultiCard format

For custom printing: Please send us a file of our labeling software M-Print PRO or M-Print PRO Online (without installation) for your labeling specifications.

General ordering data

Type	WS 10/3.5 PLUS MC NE WS	Version
Order No.	2003760000	WS, Terminal marker, 10 x 3.5 mm, Pitch in mm (P): 3.50
GTIN (EAN)	4050118424454	Weidmueller, white
Qty.	960 ST	

DEK 5/3.5

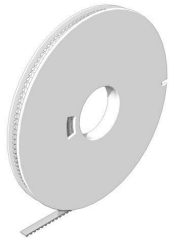

WS/ DEK

MultiMark terminal markers use an innovative composite material made from two components. The hard base contour of the marker snaps securely into the connector. The elastic surface finish makes the marker easy to mount. This specially punched material enables the strips to be stretched to accommodate the slight variations in spacing that tend to add up, especially with long terminal blocks. Another advantage: the excellent printability of the surface material guarantees durable and wear-resistant labelling. A print resolution of 300 dpi also produces a very legible script.

Your benefits with MultiMark

- Firm hold and durable printing
- Continuous strips save installation time
- Easy mounting thanks to an innovative composite material
- Large label field for optimal legibility
- High flexibility thanks to manufacturer independence

General ordering data

Type	DEK 5/3.5 MM WS	Version
Order No.	2007100000	Dekafix, Terminal marker, 5 x 3.5 mm, Weidmueller, white
GTIN (EAN)	4050118391992	
Qty.	1000 ST	

AIO21 1.5 SI DL OR

Weidmüller Interface GmbH & Co. KG
 Klingenbergstraße 26
 D-32758 Detmold
 Germany

Accessories

www.weidmueller.com

WS 8/3.5



WS/ DEK

MultiMark terminal markers use an innovative composite material made from two components. The hard base contour of the marker snaps securely into the connector. The elastic surface finish makes the marker easy to mount. This specially punched material enables the strips to be stretched to accommodate the slight variations in spacing that tend to add up, especially with long terminal blocks. Another advantage: the excellent printability of the surface material guarantees durable and wear-resistant labelling. A print resolution of 300 dpi also produces a very legible script.

Your benefits with MultiMark

- Firm hold and durable printing
- Continuous strips save installation time
- Easy mounting thanks to an innovative composite material
- Large label field for optimal legibility
- High flexibility thanks to manufacturer independence

General ordering data

Type	WS 8/3.5 MM WS	Version	
Order No.	2007140000	WS, Terminal marker, 8 x 3.5 mm, Weidmueller, white	
GTIN (EAN)	4050118391893		
Qty.	1000 ST		

Accessories



Accessories for testing and measuring equipment

General ordering data

Type	ZUB MULTIMETER	Version	
Order No.	9205270000	Multimeter	
GTIN (EAN)	4032248723522		
Qty.	1 ST		

AIO21 1.5 SI DL OR

Weidmüller Interface GmbH & Co. KG
 Klingenbergstraße 26
 D-32758 Detmold
 Germany

www.weidmueller.com

Accessories

End bracket



Weidmüller's range of products includes end brackets that guarantee a permanent, reliable mounting on the terminal rail and prevent sliding. Versions with and without screws are available. The end brackets include marking options, also for group markers, and also a test plug holder.

General ordering data

Type	AEB 35 SC/1 BK	Version	
Order No.	2475310000	A-series, End bracket	
GTIN (EAN)	4050118487114		
Qty.	50 ST		

End plates and partition plates



Partition plates and end plates are essential accessories for terminal blocks. Partition plates provide optical and electrical separation of different potentials and functional groups, increasing safety and ensuring a clear structure inside the control cabinet. End plates close the terminal block row on the sides, protect against contact with live parts, and ensure a clean, stable finish. Both components are precisely matched to the respective Weidmüller terminal block series, contributing to safe, compliant, and professional wiring.

General ordering data

Type	APP 3	Version	
Order No.	2489100000	A-series, Partition plate	
GTIN (EAN)	4050118499315		
Qty.	50 ST		

Warning cover

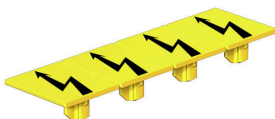

Warning covers with a flash symbol provide more safety for man and machine. They are used where external voltage must be indicated within the application.

General ordering data

Type	AAM 1.5 YE FLASH	Version	
Order No.	2635520000	A-series, Terminal marker, 6.2 x 3.5 mm, Pitch in mm (P): 3.50 yellow	
GTIN (EAN)	4050118674088		
Qty.	40 ST		

AIO21 1.5 SI DL OR

Weidmüller Interface GmbH & Co. KG
 Klingenbergstraße 26
 D-32758 Detmold
 Germany

www.weidmueller.com

Accessories

End bracket



Weidmüller's range of products includes end brackets that guarantee a permanent, reliable mounting on the terminal rail and prevent sliding. Versions with and without screws are available. The end brackets include marking options, also for group markers, and also a test plug holder.

General ordering data

Type	AEB 35 SCL/1 V0	Version
Order No.	2661280000	A-series, End bracket
GTIN (EAN)	4050118702163	
Qty.	20 ST	
Type	AEB 35 SCL/1 V0 BK	Version
Order No.	2661300000	A-series, End bracket
GTIN (EAN)	4050118702187	
Qty.	20 ST	
Type	AEB 35 SCL/1 V0 GY	Version
Order No.	2661290000	A-series, End bracket
GTIN (EAN)	4050118702170	
Qty.	20 ST	

Slotted screwdriver



Slotted screwdriver with rounded blade SD DIN 5265, ISO 2380/2, output to DIN 5264, ISO 2380/1. ChromTop tip, SoftFinish grip

General ordering data

Type	SDS 0.4X2.0X60	Version
Order No.	2749260000	Screwdriver, Blade width (B): 2 mm, Blade length: 60 mm, Blade thickness (A): 0.4 mm
GTIN (EAN)	4050118895537	
Qty.	1 ST	

AIO21 1.5 SI DL OR

Weidmüller Interface GmbH & Co. KG
Klingenbergstraße 26
D-32758 Detmold
Germany

www.weidmueller.com

Accessories

Testadapter and testsockets



Test adapters and test plugs are used for the electrical connection between terminal blocks and the test equipment. In this way, an electrical contact can be established in the wired state and measurements can be done easily.

General ordering data

Type	FZS 2/4 RT/80 SAKT4	Version	
Order No.	1276300000	Plug (terminal), Plug-in connection, 2 mm ² , Number of connections: 2,	
GTIN (EAN)	4008190026080	Number of poles: 1, Width: 9 mm	
Qty.	20 ST		