

A2C 16 DL**Weidmüller Interface GmbH & Co. KG**

Klingenbergstraße 26

D-32758 Detmold

Germany

www.weidmueller.com

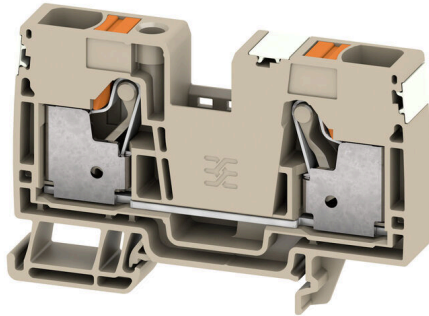

To feed through power, signal, and data is the classical requirement in electrical engineering and panel building. The insulating material, the connection system and the design of the terminal blocks are the differentiating features. A feed-through terminal block is suitable for joining and/or connecting one or more conductors. They could have one or more connection levels that are on the same potential or insulated against one another.

General ordering data

Version	Feed-through terminal, PUSH IN, 16 mm ² , 1000 V, 76 A, dark beige
Order No.	2675000000
Type	A2C 16 DL
GTIN (EAN)	4050118817454
Qty.	20 items

A2C 16 DL

Weidmüller Interface GmbH & Co. KG
 Klingenbergstraße 26
 D-32758 Detmold
 Germany

www.weidmueller.com

Technical data

Approvals

Approvals



ROHS	Conform
UL File Number Search	UL Website
Certificate No. (cURusEX)	E184763

Dimensions and weights

Depth	51.5 mm	Depth (inches)	2.0276 inch
Depth including DIN rail	52.5 mm	Height	51.5 mm
Height (inches)	2.0276 inch	Width	12 mm
Width (inches)	0.4724 inch	Net weight	38.5 g

Temperatures

Storage temperature	-25 °C...55 °C	Ambient temperature	-5 °C...40 °C
Continuous operating temp., min.	-60 °C	Continuous operating temp., max.	130 °C

Environmental Product Compliance

RoHS Compliance Status	Compliant without exemption
REACH SVHC	No SVHC above 0.1 wt%

Material data

Basic material	Wemid	Insulating material	Wemid
Colour	dark beige	UL 94 flammability rating	V-0

Rating data IECEX/ATEX

Certificate No. (ATEX)	TUEV16ATEX7909U	Certificate No. (IECEX)	IECEXTUR16.0036U
Max. voltage (ATEX)	550 V	Current (ATEX)	64 A
Wire cross section max. (ATEX)	16 mm ²	Max. voltage (IECEX)	550 V
Current (IECEX)	64 A	Wire cross section max. (IECEX)	16 mm ²

System specifications

End cover plate required	Yes	Number of potentials	1
Number of levels	1	Number of clamping points per level	2
Number of potentials per tier	1	Levels cross-connected internally	No
Mounting rail	TS 35		

Additional technical data

Open sides	right	Explosion-tested version	Yes
------------	-------	--------------------------	-----

A2C 16 DL

Weidmüller Interface GmbH & Co. KG

Klingenbergstraße 26
D-32758 Detmold
Germany

www.weidmueller.com

Technical data

Conductors for clamping (additional connection)

Connection type, additional connection PUSH IN

Conductors for clamping (rated connection)

Gauge to IEC 60947-1	A6	Wire connection cross section AWG, max.	AWG 4
Connection direction	top	Stripping length	18 mm
Type of connection	PUSH IN	Number of connections	2
Clamping range, max.	25 mm ²	Clamping range, min.	0.5 mm ²
Blade size	1.0 x 5.5 mm	Wire connection cross section AWG, min.	AWG 18
Wire connection cross-section, finely stranded with wire-end ferrules DIN 46228/4, max.	16 mm ²	Wire connection cross-section, finely stranded with wire-end ferrules DIN 46228/4, min.	0.5 mm ²
Wire connection cross-section, finely stranded with wire-end ferrules DIN 46228/1, max.	16 mm ²	Wire connection cross-section, finely stranded with wire-end ferrules DIN 46228/1, min.	0.5 mm ²
Wire connection cross section, finely stranded, max.	25 mm ²	Wire connection cross section, finely stranded, min.	0.5 mm ²
Connection cross-section, stranded, max.	25 mm ²	Connection cross-section, stranded, min.	10 mm ²
Twin wire-end ferrules, max.	6 mm ²	Twin wire-end ferrules, min.	0.75 mm ²
Wire connection cross-section, solid core, max.	16 mm ²	Wire connection cross-section, solid core, min.	0.5 mm ²

General

Wire connection cross section AWG, max.	AWG 4	Wire connection cross section AWG, min.	AWG 18
Standards	IEC 60947-7-1	Mounting rail	TS 35

Rating data

Rated cross-section	16 mm ²	Rated voltage	1000 V
Rated DC voltage	1000 V	Nominal current	76 A
Current at maximum wires	76 A	Standards	IEC 60947-7-1
Volume resistance according to IEC 60947-7-x	0.42 mΩ	Rated impulse withstand voltage	8 kV
Power loss in accordance with IEC 60947-7-x	2.43 W		

Classifications

ETIM 8.0	EC000897	ETIM 9.0	EC000897
ETIM 10.0	EC000897	ECLASS 14.0	27-25-01-01
ECLASS 15.0	27-25-01-01		

Drawings



A2C 16 DL

Weidmüller Interface GmbH & Co. KG
 Klingenbergstraße 26
 D-32758 Detmold
 Germany

www.weidmueller.com

Accessories

Accessories

Accessories for testing and measuring equipment



General ordering data

Type	ZUB MULTIMETER	Version	
Order No.	9205270000	Multimeter	
GTIN (EAN)	4032248723522		
Qty.	1 ST		

End plates and partition plates



Partition plates and end plates are essential accessories for terminal blocks. Partition plates provide optical and electrical separation of different potentials and functional groups, increasing safety and ensuring a clear structure inside the control cabinet. End plates close the terminal block row on the sides, protect against contact with live parts, and ensure a clean, stable finish. Both components are precisely matched to the respective Weidmüller terminal block series, contributing to safe, compliant, and professional wiring.

General ordering data

Type	AEP 2C 10/16	Version	
Order No.	2490380000	A-series, End plate	
GTIN (EAN)	4050118500820		
Qty.	20 ST		
Type	AEP 2C 10/16 BL	Version	
Order No.	2490390000	A-series, End plate	
GTIN (EAN)	4050118500837		
Qty.	20 ST		

End bracket

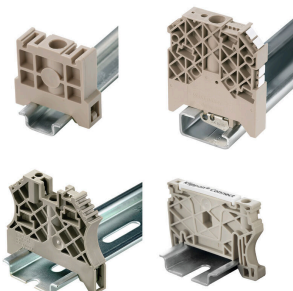

Weidmüller's range of products includes end brackets that guarantee a permanent, reliable mounting on the terminal rail and prevent sliding. Versions with and without screws are available. The end brackets include marking options, also for group markers, and also a test plug holder.

A2C 16 DL

Weidmüller Interface GmbH & Co. KG
 Klingenbergstraße 26
 D-32758 Detmold
 Germany

www.weidmueller.com

Accessories

General ordering data

Type	AEB 35 SC/1	Version
Order No.	1991920000	A-series, End bracket
GTIN (EAN)	4050118376722	
Qty.	50 ST	
Type	AEB 35 SC/1 BK	Version
Order No.	2475310000	A-series, End bracket
GTIN (EAN)	4050118487114	
Qty.	50 ST	

Testadapter and testsockets



Test adapters and test plugs are used for the electrical connection between terminal blocks and the test equipment. In this way, an electrical contact can be established in the wired state and measurements can be done easily.

General ordering data

Type	ATPG 1.5-10 L	Version
Order No.	1991890000	Test adapter (terminal), 1.5 mm ² , 250 V, 0.2 A
GTIN (EAN)	4050118376647	
Qty.	50 ST	

Blank



The Dekafix (DEK) marker is the universal marker for all conductor and plug-in connectors as well as for electronic sub-assemblies. The system is ideal for short number sequences and covers a wide range of ready-printed markers.

Strips for fast installation in only one work step. The printing is easy to read, rich in contrast and available in various widths.

- Large range of ready-to-use markers
 - Strips for fast installation
 - Terminal markers, suitable for all Weidmüller cable connectors
 - Available as blank MultiCard or with standard printing
- For custom printing: Please send us a file of our labeling software M-Print PRO or M-Print PRO Online (without installation) for your labeling specifications.

General ordering data

Type	DEK 5/8 MC NE WS	Version
Order No.	1856740000	Dekafix, Terminal marker, 5 x 8 mm, Pitch in mm (P): 8.00
GTIN (EAN)	4032248400850	Weidmueller, white
Qty.	800 ST	

A2C 16 DL

Weidmüller Interface GmbH & Co. KG
 Klingenbergstraße 26
 D-32758 Detmold
 Germany

www.weidmueller.com

Accessories

Custom printing



The Dekafix (DEK) marker is the universal marker for all conductor and plug-in connectors as well as for electronic sub-assemblies. The system is ideal for short number sequences and covers a wide range of ready-printed markers.

Strips for fast installation in only one work step. The printing is easy to read, rich in contrast and available in various widths.

- Large range of ready-to-use markers
 - Strips for fast installation
 - Terminal markers, suitable for all Weidmüller cable connectors
 - Available as blank MultiCard or with standard printing
- For custom printing: Please send us a file of our labeling software M-Print PRO or M-Print PRO Online (without installation) for your labeling specifications.

General ordering data

Type	DEK 5/8 MC SDR	Version	
Order No.	1856750000		Dekafix, Terminal marker, 5 x 8 mm, Pitch in mm (P): 8.00
GTIN (EAN)	4032248400867		Weidmueller, To customer specification
Qty.	160 ST		

Plus



The Dekafix (DEK) marker is the universal marker for all conductor and plug-in connectors as well as for electronic sub-assemblies. The system is ideal for short number sequences and covers a wide range of ready-printed markers.

Strips for fast installation in only one work step. The printing is easy to read, rich in contrast and available in various widths.

- Large range of ready-to-use markers
 - Strips for fast installation
 - Terminal markers, suitable for all Weidmüller cable connectors
 - Available as blank MultiCard or with standard printing
- For custom printing: Please send us a file of our labeling software M-Print PRO or M-Print PRO Online (without installation) for your labeling specifications.

General ordering data

Type	DEK 5/8 PLUS MC NE WS	Version	
Order No.	1046350000		Dekafix, Terminal marker, 5 x 8 mm, Pitch in mm (P): 8.00
GTIN (EAN)	4032248782055		Weidmueller, white
Qty.	800 ST		

A2C 16 DL

Weidmüller Interface GmbH & Co. KG

Klingenbergstraße 26

D-32758 Detmold

Germany

Accessories

www.weidmueller.com

Custom printing



The Dekafix (DEK) marker is the universal marker for all conductor and plug-in connectors as well as for electronic sub-assemblies. The system is ideal for short number sequences and covers a wide range of ready-printed markers.

Strips for fast installation in only one work step. The printing is easy to read, rich in contrast and available in various widths.

- Large range of ready-to-use markers
 - Strips for fast installation
 - Terminal markers, suitable for all Weidmüller cable connectors
 - Available as blank MultiCard or with standard printing
- For custom printing: Please send us a file of our labeling software M-Print PRO or M-Print PRO Online (without installation) for your labeling specifications.

General ordering data

Type	DEK 5/8 PLUS MC SDR	Version	
Order No.	1046370000		Dekafix, Terminal marker, 5 x 8 mm, Pitch in mm (P): 8.00
GTIN (EAN)	4032248782079		Weidmueller, To customer specification
Qty.	160 ST		

Blank

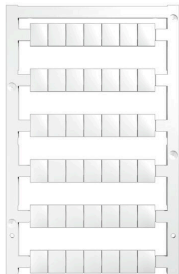

WS markers are the perfect match for the W-series connectors. Thanks to their system compatibility, the WS tags can also be used with the I-series and the Z-series. The large marking surfaces do not only permit long character strings but also multi-line text. WS markers are ideal for labels with long, customised character strings. Thanks to the proven MultiCard format, printing with PrintJet CONNECT oder/or Plotter is possible.

- Can be fitted in strips or individually
- Markers in proven MultiCard format

For custom printing: Please send us a file of our labeling software M-Print PRO or M-Print PRO Online (without installation) for your labeling specifications.

General ordering data

Type	WS 10/8 PLUS MC NE WS	Version	
Order No.	1905950000		WS, Terminal marker, 10 x 8 mm, Pitch in mm (P): 8.00 Weidmueller,
GTIN (EAN)	4032248528103		white
Qty.	420 ST		

A2C 16 DL

Weidmüller Interface GmbH & Co. KG

Klingenbergstraße 26

D-32758 Detmold

Germany

Accessories

www.weidmueller.com

Custom printing

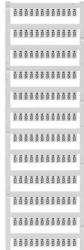

WS markers are the perfect match for the W-series connectors. Thanks to their system compatibility, the WS tags can also be used with the I-series and the Z-series. The large marking surfaces do not only permit long character strings but also multi-line text. WS markers are ideal for labels with long, customised character strings. Thanks to the proven MultiCard format, printing with PrintJet CONNECT oder/or Plotter is possible.

- Can be fitted in strips or individually
- Markers in proven MultiCard format

For custom printing: Please send us a file of our labeling software M-Print PRO or M-Print PRO Online (without installation) for your labeling specifications.

General ordering data

Type	WS 10/8 PLUS MC SDR	Version
Order No.	1906030000	WS, Terminal marker, 10 x 8 mm, Pitch in mm (P): 8.00 Weidmueller,
GTIN (EAN)	4032248528196	To customer specification
Qty.	84 ST	

Blank

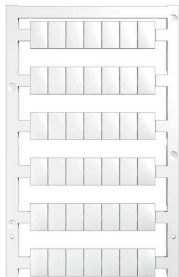

WS markers are the perfect match for the W-series connectors. Thanks to their system compatibility, the WS tags can also be used with the I-series and the Z-series. The large marking surfaces do not only permit long character strings but also multi-line text. WS markers are ideal for labels with long, customised character strings. Thanks to the proven MultiCard format, printing with PrintJet CONNECT oder/or Plotter is possible.

- Can be fitted in strips or individually
- Markers in proven MultiCard format

For custom printing: Please send us a file of our labeling software M-Print PRO or M-Print PRO Online (without installation) for your labeling specifications.

General ordering data

Type	WS 12/8 PLUS MC NE WS	Version
Order No.	1906000000	WS, Terminal marker, 12 x 8 mm, Pitch in mm (P): 8.00 Weidmueller,
GTIN (EAN)	4032248528158	white
Qty.	420 ST	

A2C 16 DL

Weidmüller Interface GmbH & Co. KG

Klingenbergstraße 26

D-32758 Detmold

Germany

www.weidmueller.com

Accessories

Custom printing



WS markers are the perfect match for the W-series connectors. Thanks to their system compatibility, the WS tags can also be used with the I-series and the Z-series. The large marking surfaces do not only permit long character strings but also multi-line text. WS markers are ideal for labels with long, customised character strings. Thanks to the proven MultiCard format, printing with PrintJet CONNECT oder/or Plotter is possible.

- Can be fitted in strips or individually
- Markers in proven MultiCard format

For custom printing: Please send us a file of our labeling software M-Print PRO or M-Print PRO Online (without installation) for your labeling specifications.

General ordering data

Type	WS 12/8 PLUS MC SDR	Version	
Order No.	1906010000	WS, Terminal marker, 12 x 8 mm, Pitch in mm (P): 8.00 Weidmueller,	
GTIN (EAN)	4032248528165	To customer specification	
Qty.	84 ST		

DEK 5/8



WS/ DEK

MultiMark terminal markers use an innovative composite material made from two components. The hard base contour of the marker snaps securely into the connector. The elastic surface finish makes the marker easy to mount. This specially punched material enables the strips to be stretched to accommodate the slight variations in spacing that tend to add up, especially with long terminal blocks. Another advantage: the excellent printability of the surface material guarantees durable and wear-resistant labelling. A print resolution of 300 dpi also produces a very legible script.

Your benefits with MultiMark

- Firm hold and durable printing
- Continuous strips save installation time
- Easy mounting thanks to an innovative composite material
- Large label field for optimal legibility
- High flexibility thanks to manufacturer independence

General ordering data

Type	DEK 5/8 MM WS	Version	
Order No.	2007130000	Dekafix, Terminal marker, 5 x 8 mm, Weidmueller, white	
GTIN (EAN)	4050118392012		
Qty.	500 ST		
Type	DEK-A 5/8 MM WS	Version	
Order No.	2448860000	Dekafix, Terminal marker, 5 x 8.1 mm, Weidmueller, white	
GTIN (EAN)	4050118462968		
Qty.	500 ST		

A2C 16 DL

Weidmüller Interface GmbH & Co. KG

Klingenbergstraße 26

D-32758 Detmold

Germany

www.weidmueller.com

Accessories

WS 8/8



WS/ DEK

MultiMark terminal markers use an innovative composite material made from two components. The hard base contour of the marker snaps securely into the connector. The elastic surface finish makes the marker easy to mount. This specially punched material enables the strips to be stretched to accommodate the slight variations in spacing that tend to add up, especially with long terminal blocks. Another advantage: the excellent printability of the surface material guarantees durable and wear-resistant labelling. A print resolution of 300 dpi also produces a very legible script.

Your benefits with MultiMark

- Firm hold and durable printing
- Continuous strips save installation time
- Easy mounting thanks to an innovative composite material
- Large label field for optimal legibility
- High flexibility thanks to manufacturer independence

General ordering data

Type	WS 8/8 MM WS	Version	
Order No.	2007170000	WS, Terminal marker, 8 x 8 mm, Weidmueller, white	
GTIN (EAN)	4050118392043		
Qty.	500 ST		
Type	WS-A 8/8 MM WS	Version	
Order No.	2448930000	WS, Terminal marker, 8 x 8.1 mm, Weidmueller, white	
GTIN (EAN)	4050118462982		
Qty.	500 ST		

WS 12/8



WS/ DEK

MultiMark terminal markers use an innovative composite material made from two components. The hard base contour of the marker snaps securely into the connector. The elastic surface finish makes the marker easy to mount. This specially punched material enables the strips to be stretched to accommodate the slight variations in spacing that tend to add up, especially with long terminal blocks. Another advantage: the excellent printability of the surface material guarantees durable and wear-resistant labelling. A print resolution of 300 dpi also produces a very legible script.

Your benefits with MultiMark

- Firm hold and durable printing
- Continuous strips save installation time
- Easy mounting thanks to an innovative composite material
- Large label field for optimal legibility
- High flexibility thanks to manufacturer independence

A2C 16 DL

Weidmüller Interface GmbH & Co. KG
 Klingenbergstraße 26
 D-32758 Detmold
 Germany

www.weidmueller.com

Accessories

General ordering data

Type	WS 12/8 MM WS	Version
Order No.	2007210000	WS, Terminal marker, 12 x 8 mm, Weidmueller, white
GTIN (EAN)	4050118392050	
Qty.	500 ST	
Type	WS-A 12/8 MM WS	Version
Order No.	2448920000	WS, Terminal marker, 12 x 8.1 mm, Weidmueller, white
GTIN (EAN)	4050118462975	
Qty.	500 ST	

Cross-connections



The distribution or multiplication of a potential to adjoining terminal blocks is realized via a cross-connection. Additional wiring effort can be easily avoided. Even if the poles are broken out, contact reliability in the terminal blocks is still ensured. Our portfolio offers pluggable and screwable cross-connection systems for modular terminal blocks.

General ordering data

Type	ZQV 16N/2	Version
Order No.	2497290000	Cross-connector (terminal), Plugged, orange, 76 A, Number of poles: 2, Pitch in mm (P): 12.00, Insulated: Yes, Width: 20.6 mm
GTIN (EAN)	4050118561906	
Qty.	25 ST	

Marker holder



The marker holder offer the possibility of additional mounting of standard markers with a pitch of 5 or 5.1 mm. The angled holders can be optionally snapped together and could be mounted in all standard marking channels of the Klippon® Connect modular terminal blocks. Fitting marker types could be found under the respective accessories of the designation marking holder.

General ordering data

Type	BZT 1 WS 10/5	Version
Order No.	1805490000	Accessories, Marker holder
GTIN (EAN)	4032248270231	
Qty.	100 ST	
Type	BZT 1 ZA WS 10/5	Version
Order No.	1805520000	Accessories, Marker holder
GTIN (EAN)	4032248270248	
Qty.	100 ST	

A2C 16 DL

Weidmüller Interface GmbH & Co. KG
 Klingenbergstraße 26
 D-32758 Detmold
 Germany

www.weidmueller.com

Accessories

Warning cover

Warning covers with a flash symbol provide more safety for man and machine. They are used where external voltage must be indicated within the application.

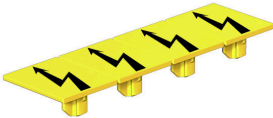

General ordering data

Type	AAM 16 YE FLASH	Version	
Order No.	2635590000	A-series, Terminal marker, 14 x 12 mm, yellow	
GTIN (EAN)	4050118674538		
Qty.	40 ST		

End bracket

Weidmüller's range of products includes end brackets that guarantee a permanent, reliable mounting on the terminal rail and prevent sliding. Versions with and without screws are available. The end brackets include marking options, also for group markers, and also a test plug holder.

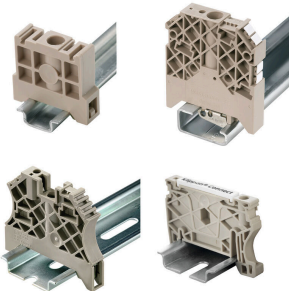

General ordering data

Type	AEB 35 SCL/1 V0	Version	
Order No.	2661280000	A-series, End bracket	
GTIN (EAN)	4050118702163		
Qty.	20 ST		
Type	AEB 35 SCL/1 V0 BK	Version	
Order No.	2661300000	A-series, End bracket	
GTIN (EAN)	4050118702187		
Qty.	20 ST		
Type	AEB 35 SCL/1 V0 GY	Version	
Order No.	2661290000	A-series, End bracket	
GTIN (EAN)	4050118702170		
Qty.	20 ST		

A2C 16 DL

Weidmüller Interface GmbH & Co. KG
 Klingenbergstraße 26
 D-32758 Detmold
 Germany

www.weidmueller.com

Accessories

Slotted screwdriver

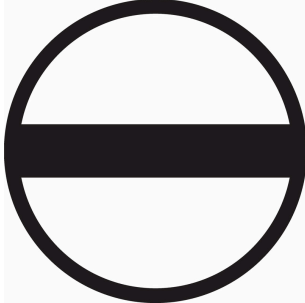

Slotted screwdriver with rounded blade SD DIN 5265, ISO 2380/2, output to DIN 5264, ISO 2380/1. ChromTop tip, SoftFinish grip

General ordering data

Type	SDS 1.0X5.5X150	Version	
Order No.	2749380000	Screwdriver, Blade width (B): 5.5 mm, Blade length: 150 mm, Blade thickness (A): 1 mm	
GTIN (EAN)	4050118895605		
Qty.	1 ST		

Testadapter and testsockets



Test adapters and test plugs are used for the electrical connection between terminal blocks and the test equipment. In this way, an electrical contact can be established in the wired state and measurements can be done easily.

General ordering data

Type	FZS 2/4 RT/80 SAKT4	Version	
Order No.	1276300000	Plug (terminal), Plug-in connection, 2 mm ² , Number of connections: 2, Number of poles: 1, Width: 9 mm	
GTIN (EAN)	4008190026080		
Qty.	20 ST		