

A4C 4 PE DL**Weidmüller Interface GmbH & Co. KG**

Klingenbergstraße 26

D-32758 Detmold

Germany

www.weidmueller.com

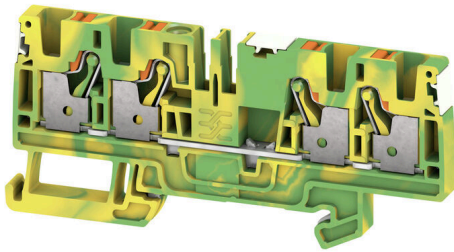

To feed through power, signal, and data is the classical requirement in electrical engineering and panel building. The insulating material, the connection system and the design of the terminal blocks are the differentiating features. A feed-through terminal block is suitable for joining and/or connecting one or more conductors. They could have one or more connection levels that are on the same potential or insulated against one another.

General ordering data

Version	PE terminal, PUSH IN, 4 mm ² , Green/yellow
Order No.	2674860000
Type	A4C 4 PE DL
GTIN (EAN)	4050118817379
Qty.	50 items

A4C 4 PE DL

Weidmüller Interface GmbH & Co. KG
 Klingenbergstraße 26
 D-32758 Detmold
 Germany

www.weidmueller.com

Technical data

Approvals

Approvals



ROHS	Conform
UL File Number Search	UL Website
Certificate No. (cURusEX)	E184763

Dimensions and weights

Depth	39.5 mm	Depth (inches)	1.5551 inch
Depth including DIN rail	40.5 mm	Height	39.5 mm
Height (inches)	1.5551 inch	Width	6.1 mm
Width (inches)	0.2402 inch	Net weight	18.88 g

Temperatures

Storage temperature	-25 °C...55 °C	Ambient temperature	-5 °C...40 °C
Continuous operating temp., min.	-60 °C	Continuous operating temp., max.	130 °C

Environmental Product Compliance

RoHS Compliance Status	Compliant without exemption
REACH SVHC	No SVHC above 0.1 wt%

Material data

Basic material	Wemid	Colour	Green/yellow
UL 94 flammability rating	V-0		

Rating data IECEX/ATEX

Certificate No. (ATEX)	TUEV16ATEX7909U	Certificate No. (IECEX)	IECEXTUR16.0036U
Wire cross section max. (ATEX)	4 mm ²	Wire cross section max. (IECEX)	4 mm ²

System specifications

End cover plate required	Yes	Number of potentials	1
Number of levels	1	Number of clamping points per level	4
Number of potentials per tier	1	PE connection	Yes
Mounting rail	TS 35	PE function	Yes
PEN function	No		

Additional technical data

Open sides	right	Explosion-tested version	Yes
Type of mounting	TS 35		

A4C 4 PE DL

Weidmüller Interface GmbH & Co. KG
 Klingenbergstraße 26
 D-32758 Detmold
 Germany

www.weidmueller.com

Technical data

Conductors for clamping (additional connection)

Connection type, additional connection PUSH IN

Conductors for clamping (rated connection)

Gauge to IEC 60947-1	A4		
Wire connection cross section AWG, max.	AWG 12		
Connection direction	top		
Stripping length	12 mm		
Type of connection	PUSH IN		
Number of connections	4		
Clamping range, max.	6 mm ²		
Clamping range, min.	0.14 mm ²		
Blade size	0.6 x 3.5 mm		
Wire connection cross section AWG, min.	AWG 26		
Wire connection cross-section, finely stranded with wire-end ferrules DIN 46228/4, max.	4 mm ²		
Wire connection cross-section, finely stranded with wire-end ferrules DIN 46228/4, min.	0.14 mm ²		
Wire connection cross-section, finely stranded with wire-end ferrules DIN 46228/1, max.	6 mm ²		
Wire connection cross-section, finely stranded with wire-end ferrules DIN 46228/1, min.	0.14 mm ²		
Wire connection cross section, finely stranded, max.	6 mm ²		
Wire connection cross section, finely stranded, min.	0.14 mm ²		
Connection cross-section, stranded, max.	6 mm ²		
Connection cross-section, stranded, min.	0.14 mm ²		
Twin wire-end ferrules, max.	1.5 mm ²		
Twin wire-end ferrules, min.	0.5 mm ²		
Wire connection cross-section, solid core, max.	4 mm ²		
Wire connection cross-section, solid core, min.	0.14 mm ²		
Connection cross-section, finely stranded, min.	0.14 mm ²		
Tube length for wire-end ferrule with plastic collar DIN 46228/4	Tube length	min.	6 mm
		max.	12 mm
	Cross-section for conductor connection	min.	0.5 mm ²
		max.	1 mm ²
	Tube length	min.	8 mm
		max.	12 mm
Cross-section for conductor connection	min.	1.5 mm ²	
	max.	2.5 mm ²	
Tube length for twin wire-end ferrule	Tube length	min.	10 mm
		max.	12 mm
	Cross-section for conductor connection	nominal	4 mm ²
		min.	0.5 mm ²
		max.	1.5 mm ²

A4C 4 PE DL

Weidmüller Interface GmbH & Co. KG

Klingenbergstraße 26
D-32758 Detmold
Germany

www.weidmueller.com

Technical data

Tube length for wire-end ferrule without plastic collar DIN 46228/1	Tube length	min.	6 mm
		max.	10 mm
	Cross-section for conductor connection	min.	0.5 mm ²
		max.	1 mm ²
	Tube length	min.	7 mm
		max.	12 mm
	Cross-section for conductor connection	min.	1.5 mm ²
		max.	2.5 mm ²
	Tube length	min.	9 mm
		max.	15 mm
	Cross-section for conductor connection	min.	4 mm ²
		max.	6 mm ²
Tube length for wire-end ferrule with plastic collar acc. to cross-section	Cross-section, min.	0.5 mm ²	
	Cross-section, max.	1 mm ²	
	Tube length, min.	6 mm	
	Tube length, max.	12 mm	
	Cross-section, min.	1.5 mm ²	
	Cross-section, max.	2.5 mm ²	
	Tube length, min.	8 mm	
	Tube length, max.	12 mm	
	Cross-section, min.	4 mm ²	
	Cross-section, max.	4 mm ²	
	Tube length, min.	10 mm	
	Tube length, max.	12 mm	
Tube length for wire-end ferrule without plastic collar acc. to cross-section	Cross-section, min.	0.5 mm ²	
	Cross-section, max.	1 mm ²	
	Tube length, min.	6 mm	
	Tube length, max.	10 mm	
	Cross-section, min.	1.5 mm ²	
	Cross-section, max.	2.5 mm ²	
	Tube length, min.	7 mm	
	Tube length, max.	12 mm	
	Cross-section, min.	4 mm ²	
	Cross-section, max.	4 mm ²	
	Tube length, min.	9 mm	
	Tube length, max.	15 mm	
Tube length for twin wire-end ferrule acc. to cross-section	Cross-section, min.	0.5 mm ²	
	Cross-section, max.	1.5 mm ²	
	Tube length, min.	8 mm	
	Tube length, max.	12 mm	

General

Wire connection cross section AWG, max.	AWG 12	Wire connection cross section AWG, min.	AWG 26
Standards	IEC 60947-7-2	Mounting rail	TS 35

Rating data

Rated cross-section	4 mm ²	Rated voltage to adjoining terminal	800 V
Rated DC voltage	800 V	Standards	IEC 60947-7-2
Volume resistance according to IEC 60947-7-x	1 mΩ	Rated impulse withstand voltage	8 kV
Power loss in accordance with IEC 60947-7-x	1.02 W		

Technical data

Classifications

ETIM 8.0	EC000901	ETIM 9.0	EC000901
ETIM 10.0	EC000901	ECLASS 14.0	27-25-01-03
ECLASS 15.0	27-25-01-03		

Drawings

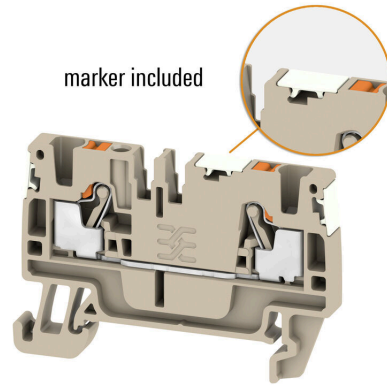
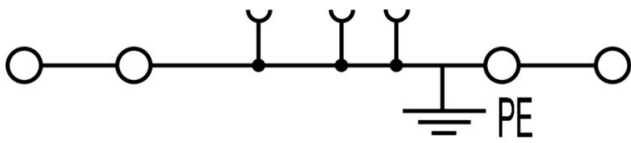

A4C 4 PE DL

Weidmüller Interface GmbH & Co. KG

Klingenbergstraße 26

D-32758 Detmold

Germany

www.weidmueller.com

Accessories

End bracket

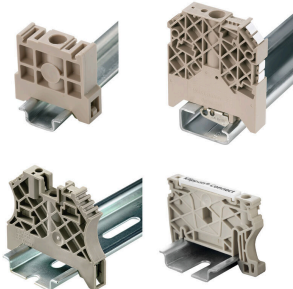

Weidmüller's range of products includes end brackets that guarantee a permanent, reliable mounting on the terminal rail and prevent sliding. Versions with and without screws are available. The end brackets include marking options, also for group markers, and also a test plug holder.

General ordering data

Type	AEB 35 SC/1	Version	
Order No.	1991920000	Version	A-series, End bracket
GTIN (EAN)	4050118376722		
Qty.	50 ST		

Testadapter and testsockets



Test adapters and test plugs are used for the electrical connection between terminal blocks and the test equipment. In this way, an electrical contact can be established in the wired state and measurements can be done easily.

General ordering data

Type	ATPG 4 MI-R	Version	
Order No.	1991860000	Version	Test adapter (terminal), 1.5 mm ² , 250 V, 0.2 A
GTIN (EAN)	4050118376661		
Qty.	50 ST		
Type	ATPG 1.5-10 L	Version	
Order No.	1991890000	Version	Test adapter (terminal), 1.5 mm ² , 250 V, 0.2 A
GTIN (EAN)	4050118376647		
Qty.	50 ST		

Cross-connections

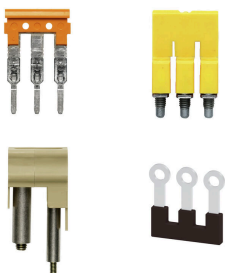

The distribution or multiplication of a potential to adjoining terminal blocks is realized via a cross-connection. Additional wiring effort can be easily avoided. Even if the poles are broken out, contact reliability in the terminal blocks is still ensured. Our portfolio offers pluggable and screwable cross-connection systems for modular terminal blocks.

A4C 4 PE DL

Weidmüller Interface GmbH & Co. KG

Klingenbergstraße 26
D-32758 Detmold
Germany

www.weidmueller.com

Accessories

General ordering data

Type	ZQV 4N/10	Version
Order No.	1528090000	Cross-connector (terminal), Plugged, orange, 32 A, Number of poles:
GTIN (EAN)	4050118332896	10, Pitch in mm (P): 6.10, Insulated: Yes, Width: 58.7 mm
Qty.	20 ST	
Type	ZQV 4N/10 BL	Version
Order No.	1528230000	Cross-connector (terminal), Plugged, blue, 32 A, Number of poles: 10,
GTIN (EAN)	4050118333138	Pitch in mm (P): 6.10, Insulated: Yes, Width: 58.7 mm
Qty.	20 ST	
Type	ZQV 4N/2	Version
Order No.	1527930000	Cross-connector (terminal), Plugged, orange, 32 A, Number of poles:
GTIN (EAN)	4050118332766	2, Pitch in mm (P): 6.10, Insulated: Yes, Width: 9.9 mm
Qty.	60 ST	
Type	ZQV 4N/2 BL	Version
Order No.	1528040000	Cross-connector (terminal), Plugged, blue, 32 A, Number of poles: 2,
GTIN (EAN)	4050118332773	Pitch in mm (P): 6.10, Insulated: Yes, Width: 9.9 mm
Qty.	60 ST	
Type	ZQV 4N/3	Version
Order No.	1527940000	Cross-connector (terminal), Plugged, orange, 32 A, Number of poles:
GTIN (EAN)	4050118332865	3, Pitch in mm (P): 6.10, Insulated: Yes, Width: 16 mm
Qty.	60 ST	
Type	ZQV 4N/3 BL	Version
Order No.	1528080000	Cross-connector (terminal), Plugged, blue, 32 A, Number of poles: 3,
GTIN (EAN)	4050118333008	Pitch in mm (P): 6.10, Insulated: Yes, Width: 16 mm
Qty.	60 ST	
Type	ZQV 4N/4	Version
Order No.	1527970000	Cross-connector (terminal), Plugged, orange, 32 A, Number of poles:
GTIN (EAN)	4050118332889	4, Pitch in mm (P): 6.10, Insulated: Yes, Width: 22.1 mm
Qty.	60 ST	
Type	ZQV 4N/4 BL	Version
Order No.	1528120000	Cross-connector (terminal), Plugged, blue, 32 A, Number of poles: 4,
GTIN (EAN)	4050118332872	Pitch in mm (P): 6.10, Insulated: Yes, Width: 22.1 mm
Qty.	60 ST	
Type	ZQV 4N/5	Version
Order No.	1527980000	Cross-connector (terminal), Plugged, orange, 32 A, Number of poles:
GTIN (EAN)	4050118332759	5, Pitch in mm (P): 6.10, Insulated: Yes, Width: 28.2 mm
Qty.	60 ST	
Type	ZQV 4N/5 BL	Version
Order No.	1528140000	Cross-connector (terminal), Plugged, blue, 32 A, Number of poles: 5,
GTIN (EAN)	4050118333015	Pitch in mm (P): 6.10, Insulated: Yes, Width: 28.2 mm
Qty.	60 ST	
Type	ZQV 4N/50	Version
Order No.	1528130000	Cross-connector (terminal), Plugged, orange, 32 A, Number of poles:
GTIN (EAN)	4050118332902	50, Pitch in mm (P): 6.10, Insulated: Yes, Width: 303.7 mm
Qty.	5 ST	
Type	ZQV 4N/50 BL	Version
Order No.	1528240000	Cross-connector (terminal), Plugged, blue, 32 A, Number of poles: 50,
GTIN (EAN)	4050118333121	Pitch in mm (P): 6.10, Insulated: Yes, Width: 303.7 mm
Qty.	5 ST	
Type	ZQV 4N/6	Version
Order No.	1527990000	Cross-connector (terminal), Plugged, orange, 32 A, Number of poles:
GTIN (EAN)	4050118332919	6, Pitch in mm (P): 6.10, Insulated: Yes, Width: 34.3 mm
Qty.	20 ST	

A4C 4 PE DL

Weidmüller Interface GmbH & Co. KG
 Klingenbergstraße 26
 D-32758 Detmold
 Germany

www.weidmueller.com

Accessories

Type	ZQV 4N/6 BL	Version
Order No.	1528170000	Cross-connector (terminal), Plugged, blue, 32 A, Number of poles: 6,
GTIN (EAN)	4050118332926	Pitch in mm (P): 6.10, Insulated: Yes, Width: 34.3 mm
Qty.	20 ST	
Type	ZQV 4N/7	Version
Order No.	1528020000	Cross-connector (terminal), Plugged, orange, 32 A, Number of poles: 7,
GTIN (EAN)	4050118332780	Pitch in mm (P): 6.10, Insulated: Yes, Width: 40.4 mm
Qty.	20 ST	
Type	ZQV 4N/7 BL	Version
Order No.	1528180000	Cross-connector (terminal), Plugged, blue, 32 A, Number of poles: 7,
GTIN (EAN)	4050118333114	Pitch in mm (P): 6.10, Insulated: Yes, Width: 40.4 mm
Qty.	20 ST	
Type	ZQV 4N/8	Version
Order No.	1528030000	Cross-connector (terminal), Plugged, orange, 32 A, Number of poles: 8,
GTIN (EAN)	4050118332841	Pitch in mm (P): 6.10, Insulated: Yes, Width: 46.5 mm
Qty.	20 ST	
Type	ZQV 4N/8 BL	Version
Order No.	1528190000	Cross-connector (terminal), Plugged, blue, 32 A, Number of poles: 8,
GTIN (EAN)	4050118332858	Pitch in mm (P): 6.10, Insulated: Yes, Width: 46.5 mm
Qty.	20 ST	
Type	ZQV 4N/9	Version
Order No.	1528070000	Cross-connector (terminal), Plugged, orange, 32 A, Number of poles: 9,
GTIN (EAN)	4050118332797	Pitch in mm (P): 6.10, Insulated: Yes, Width: 52.6 mm
Qty.	20 ST	
Type	ZQV 4N/9 BL	Version
Order No.	1528220000	Cross-connector (terminal), Plugged, blue, 32 A, Number of poles: 9,
GTIN (EAN)	4050118333107	Pitch in mm (P): 6.10, Insulated: Yes, Width: 52.6 mm
Qty.	20 ST	

Blank



The Dekafix (DEK) marker is the universal marker for all conductor and plug-in connectors as well as for electronic sub-assemblies. The system is ideal for short number sequences and covers a wide range of ready-printed markers.

Strips for fast installation in only one work step. The printing is easy to read, rich in contrast and available in various widths.

- Large range of ready-to-use markers
 - Strips for fast installation
 - Terminal markers, suitable for all Weidmüller cable connectors
 - Available as blank MultiCard or with standard printing
- For custom printing: Please send us a file of our labeling software M-Print PRO or M-Print PRO Online (without installation) for your labeling specifications.

General ordering data

Type	DEK 5/6 MC NE BL	Version
Order No.	1238290000	Dekafix, Terminal marker, 5 x 6 mm, Pitch in mm (P): 6.00
GTIN (EAN)	4050118267327	Weidmueller, blue
Qty.	1000 ST	

A4C 4 PE DL

Weidmüller Interface GmbH & Co. KG
 Klingenbergstraße 26
 D-32758 Detmold
 Germany

www.weidmueller.com

Accessories

Type	DEK 5/6 MC NE BR	Version
Order No.	1454900000	Dekafix, Terminal marker, 5 x 6 mm, Pitch in mm (P): 6.00
GTIN (EAN)	4050118323313	Weidmueller, brown
Qty.	1000 ST	
Type	DEK 5/6 MC NE GE	Version
Order No.	1238280000	Dekafix, Terminal marker, 5 x 6 mm, Pitch in mm (P): 6.00
GTIN (EAN)	4050118038750	Weidmueller, yellow
Qty.	1000 ST	
Type	DEK 5/6 MC NE GN	Version
Order No.	1238310000	Dekafix, Terminal marker, 5 x 6 mm, Pitch in mm (P): 6.00
GTIN (EAN)	4050118271812	Weidmueller, green
Qty.	1000 ST	
Type	DEK 5/6 MC NE GR	Version
Order No.	1238330000	Dekafix, Terminal marker, 5 x 6 mm, Pitch in mm (P): 6.00
GTIN (EAN)	4050118323306	Weidmueller, grey
Qty.	1000 ST	
Type	DEK 5/6 MC NE OR	Version
Order No.	1912090000	Dekafix, Terminal marker, 5 x 6 mm, Pitch in mm (P): 6.00
GTIN (EAN)	4032248540525	Weidmueller, orange
Qty.	1000 ST	
Type	DEK 5/6 MC NE WS	Version
Order No.	1609820000	Dekafix, Terminal marker, 5 x 6 mm, Pitch in mm (P): 6.00
GTIN (EAN)	4008190203436	Weidmueller, white
Qty.	1000 ST	

Custom printing



The Dekafix (DEK) marker is the universal marker for all conductor and plug-in connectors as well as for electronic sub-assemblies. The system is ideal for short number sequences and covers a wide range of ready-printed markers.

Strips for fast installation in only one work step. The printing is easy to read, rich in contrast and available in various widths.

- Large range of ready-to-use markers
- Strips for fast installation
- Terminal markers, suitable for all Weidmüller cable connectors
- Available as blank MultiCard or with standard printing

For custom printing: Please send us a file of our labeling software M-Print PRO or M-Print PRO Online (without installation) for your labeling specifications.

General ordering data

Type	DEK 5/6 MC SDR	Version
Order No.	1609830000	Dekafix, Terminal marker, 5 x 6 mm, Pitch in mm (P): 6.00
GTIN (EAN)	4008190456603	Weidmueller, To customer specification
Qty.	200 ST	

A4C 4 PE DL

Weidmüller Interface GmbH & Co. KG

Klingenbergstraße 26
D-32758 Detmold
Germany

www.weidmueller.com

Accessories

Plus



The Dekafix (DEK) marker is the universal marker for all conductor and plug-in connectors as well as for electronic sub-assemblies. The system is ideal for short number sequences and covers a wide range of ready-printed markers.

Strips for fast installation in only one work step. The printing is easy to read, rich in contrast and available in various widths.

- Large range of ready-to-use markers
 - Strips for fast installation
 - Terminal markers, suitable for all Weidmüller cable connectors
 - Available as blank MultiCard or with standard printing
- For custom printing: Please send us a file of our labeling software M-Print PRO or M-Print PRO Online (without installation) for your labeling specifications.

General ordering data

Type	DEK 5/6 PLUS MC NE WS	Version
Order No.	1011320000	Dekafix, Terminal marker, 5 x 6 mm, Pitch in mm (P): 6.00
GTIN (EAN)	4032248717644	Weidmueller, white
Qty.	1000 ST	

Custom printing



The Dekafix (DEK) marker is the universal marker for all conductor and plug-in connectors as well as for electronic sub-assemblies. The system is ideal for short number sequences and covers a wide range of ready-printed markers.

Strips for fast installation in only one work step. The printing is easy to read, rich in contrast and available in various widths.

- Large range of ready-to-use markers
 - Strips for fast installation
 - Terminal markers, suitable for all Weidmüller cable connectors
 - Available as blank MultiCard or with standard printing
- For custom printing: Please send us a file of our labeling software M-Print PRO or M-Print PRO Online (without installation) for your labeling specifications.

General ordering data

Type	DEK 5/6 PLUS MC SDR	Version
Order No.	1038650000	Dekafix, Terminal marker, 5 x 6 mm, Pitch in mm (P): 6.00
GTIN (EAN)	4032248767908	Weidmueller, To customer specification
Qty.	200 ST	
Type	WS 10/6 M PLUS MC SDR	Version
Order No.	2007780000	WS, Terminal marker, 10 x 6 mm, Pitch in mm (P): 6.00 Weidmueller,
GTIN (EAN)	4050118393187	Allen-Bradley, To customer specification
Qty.	120 ST	

A4C 4 PE DL

Weidmüller Interface GmbH & Co. KG

Klingenbergstraße 26

D-32758 Detmold

Germany

Accessories

www.weidmueller.com

Blank



WS markers are the perfect match for the W-series connectors. Thanks to their system compatibility, the WS tags can also be used with the I-series and the Z-series. The large marking surfaces do not only permit long character strings but also multi-line text. WS markers are ideal for labels with long, customised character strings. Thanks to the proven MultiCard format, printing with PrintJet CONNECT oder/or Plotter is possible.

- Can be fitted in strips or individually
- Markers in proven MultiCard format

For custom printing: Please send us a file of our labeling software M-Print PRO or M-Print PRO Online (without installation) for your labeling specifications.

General ordering data

Type	WS 10/6 M PLUS MC NE WS	Version
Order No.	2003780000	WS, Terminal marker, 10 x 6 mm, Pitch in mm (P): 6.00 Weidmueller,
GTIN (EAN)	4050118424461	Allen-Bradley, white
Qty.	600 ST	
Type	WS 10/6 MC M NE BL	Version
Order No.	1069080000	WS, Terminal marker, 10 x 6 mm, Pitch in mm (P): 6.00 Weidmueller,
GTIN (EAN)	4032248824618	Allen-Bradley, blue
Qty.	600 ST	
Type	WS 10/6 MC M NE GE	Version
Order No.	1917430000	WS, Terminal marker, 10 x 6 mm, Pitch in mm (P): 6.00 Weidmueller,
GTIN (EAN)	4032248551637	Allen-Bradley, yellow
Qty.	600 ST	
Type	WS 10/6 MC M NE GN	Version
Order No.	1917420000	WS, Terminal marker, 10 x 6 mm, Pitch in mm (P): 6.00 Weidmueller,
GTIN (EAN)	4032248551620	Allen-Bradley, green
Qty.	600 ST	
Type	WS 10/6 MC M NE RT	Version
Order No.	1917440000	WS, Terminal marker, 10 x 6 mm, Pitch in mm (P): 6.00 Weidmueller,
GTIN (EAN)	4032248551644	Allen-Bradley, red
Qty.	600 ST	
Type	WS 10/6 M MC NE WS	Version
Order No.	1818400000	WS, Terminal marker, 10 x 6 mm, Pitch in mm (P): 6.00 Weidmueller,
GTIN (EAN)	4032248310876	Allen-Bradley, white
Qty.	600 ST	

A4C 4 PE DL

Weidmüller Interface GmbH & Co. KG

Klingenbergstraße 26

D-32758 Detmold

Germany

Accessories

www.weidmueller.com

Custom printing

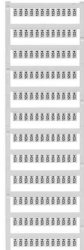

WS markers are the perfect match for the W-series connectors. Thanks to their system compatibility, the WS tags can also be used with the I-series and the Z-series. The large marking surfaces do not only permit long character strings but also multi-line text. WS markers are ideal for labels with long, customised character strings. Thanks to the proven MultiCard format, printing with PrintJet CONNECT oder/or Plotter is possible.

- Can be fitted in strips or individually
- Markers in proven MultiCard format

For custom printing: Please send us a file of our labeling software M-Print PRO or M-Print PRO Online (without installation) for your labeling specifications.

General ordering data

Type	WS 10/6 MC M SDR	Version
Order No.	1818410000	WS, Terminal marker, 10 x 6 mm, Pitch in mm (P): 6.00 Weidmueller,
GTIN (EAN)	4032248310883	Allen-Bradley, To customer specification
Qty.	120 ST	

Blank



WS markers are the perfect match for the W-series connectors. Thanks to their system compatibility, the WS tags can also be used with the I-series and the Z-series. The large marking surfaces do not only permit long character strings but also multi-line text. WS markers are ideal for labels with long, customised character strings. Thanks to the proven MultiCard format, printing with PrintJet CONNECT oder/or Plotter is possible.

- Can be fitted in strips or individually
- Markers in proven MultiCard format

For custom printing: Please send us a file of our labeling software M-Print PRO or M-Print PRO Online (without installation) for your labeling specifications.

General ordering data

Type	WS 10/6 MC NE WS	Version
Order No.	1828450000	WS, Terminal marker, 10 x 6 mm, Pitch in mm (P): 6.00 Weidmueller,
GTIN (EAN)	4032248350513	Allen-Bradley, white
Qty.	600 ST	

A4C 4 PE DL

Weidmüller Interface GmbH & Co. KG

Klingenbergstraße 26

D-32758 Detmold

Germany

Accessories

www.weidmueller.com

Custom printing

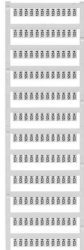

WS markers are the perfect match for the W-series connectors. Thanks to their system compatibility, the WS tags can also be used with the I-series and the Z-series. The large marking surfaces do not only permit long character strings but also multi-line text. WS markers are ideal for labels with long, customised character strings. Thanks to the proven MultiCard format, printing with PrintJet CONNECT oder/or Plotter is possible.

- Can be fitted in strips or individually
- Markers in proven MultiCard format

For custom printing: Please send us a file of our labeling software M-Print PRO or M-Print PRO Online (without installation) for your labeling specifications.

General ordering data

Type	WS 10/6 MC SDR	Version
Order No.	1828460000	WS, Terminal marker, 10 x 6 mm, Pitch in mm (P): 6.00 Weidmueller,
GTIN (EAN)	4032248367399	Allen-Bradley, To customer specification
Qty.	120 ST	

Blank



WS markers are the perfect match for the W-series connectors. Thanks to their system compatibility, the WS tags can also be used with the I-series and the Z-series. The large marking surfaces do not only permit long character strings but also multi-line text. WS markers are ideal for labels with long, customised character strings. Thanks to the proven MultiCard format, printing with PrintJet CONNECT oder/or Plotter is possible.

- Can be fitted in strips or individually
- Markers in proven MultiCard format

For custom printing: Please send us a file of our labeling software M-Print PRO or M-Print PRO Online (without installation) for your labeling specifications.

General ordering data

Type	WS 10/6 PLUS MC NE WS	Version
Order No.	1046390000	WS, Terminal marker, 10 x 6 mm, Pitch in mm (P): 6.00 Weidmueller,
GTIN (EAN)	4032248782109	Allen-Bradley, white
Qty.	600 ST	

A4C 4 PE DL

Weidmüller Interface GmbH & Co. KG
 Klingenbergstraße 26
 D-32758 Detmold
 Germany

www.weidmueller.com

Accessories

Custom printing

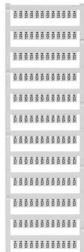

WS markers are the perfect match for the W-series connectors. Thanks to their system compatibility, the WS tags can also be used with the I-series and the Z-series. The large marking surfaces do not only permit long character strings but also multi-line text. WS markers are ideal for labels with long, customised character strings. Thanks to the proven MultiCard format, printing with PrintJet CONNECT oder/or Plotter is possible.

- Can be fitted in strips or individually
- Markers in proven MultiCard format

For custom printing: Please send us a file of our labeling software M-Print PRO or M-Print PRO Online (without installation) for your labeling specifications.

General ordering data

Type	WS 10/6 PLUS MC SDR	Version
Order No.	1046330000	WS, Terminal marker, 10 x 6 mm, Pitch in mm (P): 6.00 Weidmueller,
GTIN (EAN)	4032248782031	Allen-Bradley, To customer specification
Qty.	120 ST	

Blank

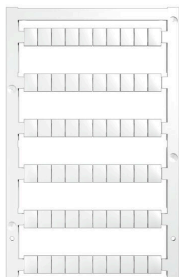

WS markers are the perfect match for the W-series connectors. Thanks to their system compatibility, the WS tags can also be used with the I-series and the Z-series. The large marking surfaces do not only permit long character strings but also multi-line text. WS markers are ideal for labels with long, customised character strings. Thanks to the proven MultiCard format, printing with PrintJet CONNECT oder/or Plotter is possible.

- Can be fitted in strips or individually
- Markers in proven MultiCard format

For custom printing: Please send us a file of our labeling software M-Print PRO or M-Print PRO Online (without installation) for your labeling specifications.

General ordering data

Type	WS 8/6 PLUS MC NE WS	Version
Order No.	1951880000	WS, Terminal marker, 8 x 6 mm, Pitch in mm (P): 6.00 Weidmueller,
GTIN (EAN)	4032248632114	white
Qty.	600 ST	

A4C 4 PE DL

Weidmüller Interface GmbH & Co. KG

Klingenbergstraße 26

D-32758 Detmold

Germany

Accessories

www.weidmueller.com

Custom printing

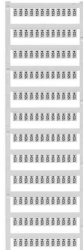

WS markers are the perfect match for the W-series connectors. Thanks to their system compatibility, the WS tags can also be used with the I-series and the Z-series. The large marking surfaces do not only permit long character strings but also multi-line text. WS markers are ideal for labels with long, customised character strings. Thanks to the proven MultiCard format, printing with PrintJet CONNECT oder/or Plotter is possible.

- Can be fitted in strips or individually
- Markers in proven MultiCard format

For custom printing: Please send us a file of our labeling software M-Print PRO or M-Print PRO Online (without installation) for your labeling specifications.

General ordering data

Type	WS 8/6 PLUS MC SDR	Version	
Order No.	1038820000	WS, Terminal marker, 8 x 6 mm, Pitch in mm (P): 6.00 Weidmueller,	
GTIN (EAN)	4032248768073	To customer specification	
Qty.	120 ST		

DEK 5/6



WS/ DEK

MultiMark terminal markers use an innovative composite material made from two components. The hard base contour of the marker snaps securely into the connector. The elastic surface finish makes the marker easy to mount. This specially punched material enables the strips to be stretched to accommodate the slight variations in spacing that tend to add up, especially with long terminal blocks. Another advantage: the excellent printability of the surface material guarantees durable and wear-resistant labelling. A print resolution of 300 dpi also produces a very legible script.

Your benefits with MultiMark

- Firm hold and durable printing
- Continuous strips save installation time
- Easy mounting thanks to an innovative composite material
- Large label field for optimal legibility
- High flexibility thanks to manufacturer independence

General ordering data

Type	DEK 5/6 MM WS	Version	
Order No.	2007120000	Dekafix, Terminal marker, 5 x 6 mm, Weidmueller, white	
GTIN (EAN)	4050118392104		
Qty.	600 ST		

A4C 4 PE DL

Weidmüller Interface GmbH & Co. KG

Klingenbergstraße 26

D-32758 Detmold

Germany

Accessories

www.weidmueller.com

WS 8/6



WS/ DEK

MultiMark terminal markers use an innovative composite material made from two components. The hard base contour of the marker snaps securely into the connector. The elastic surface finish makes the marker easy to mount. This specially punched material enables the strips to be stretched to accommodate the slight variations in spacing that tend to add up, especially with long terminal blocks. Another advantage: the excellent printability of the surface material guarantees durable and wear-resistant labelling. A print resolution of 300 dpi also produces a very legible script.

Your benefits with MultiMark

- Firm hold and durable printing
- Continuous strips save installation time
- Easy mounting thanks to an innovative composite material
- Large label field for optimal legibility
- High flexibility thanks to manufacturer independence

General ordering data

Type	WS 8/6 MM WS	Version	
Order No.	2007160000	WS, Terminal marker, 8 x 6 mm, Weidmueller, white	
GTIN (EAN)	4050118391879		
Qty.	600 ST		

End plates and partition plates



Partition plates and end plates are essential accessories for terminal blocks. Partition plates provide optical and electrical separation of different potentials and functional groups, increasing safety and ensuring a clear structure inside the control cabinet. End plates close the terminal block row on the sides, protect against contact with live parts, and ensure a clean, stable finish. Both components are precisely matched to the respective Weidmüller terminal block series, contributing to safe, compliant, and professional wiring.

General ordering data

Type	AEP 4C 4	Version	
Order No.	2051900000	A-series, End plate	
GTIN (EAN)	4050118412017		
Qty.	20 ST		
Type	AEP 4C 4 BL	Version	
Order No.	2051910000	A-series, End plate	
GTIN (EAN)	4050118411904		
Qty.	20 ST		
Type	AEP 4C 4 OR	Version	
Order No.	2051920000	A-series, End plate	
GTIN (EAN)	4050118412000		
Qty.	20 ST		

A4C 4 PE DL

Weidmüller Interface GmbH & Co. KG
 Klingenbergstraße 26
 D-32758 Detmold
 Germany

www.weidmueller.com

Accessories

Accessories

Accessories for testing and measuring equipment



General ordering data

Type	ZUB MULTIMETER	Version	
Order No.	9205270000	Multimeter	
GTIN (EAN)	4032248723522		
Qty.	1 ST		

End bracket

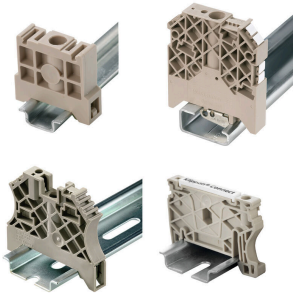

Weidmüller's range of products includes end brackets that guarantee a permanent, reliable mounting on the terminal rail and prevent sliding. Versions with and without screws are available. The end brackets include marking options, also for group markers, and also a test plug holder.

General ordering data

Type	AEB 35 SC/1 BK	Version	
Order No.	2475310000	A-series, End bracket	
GTIN (EAN)	4050118487114		
Qty.	50 ST		

Marker holder

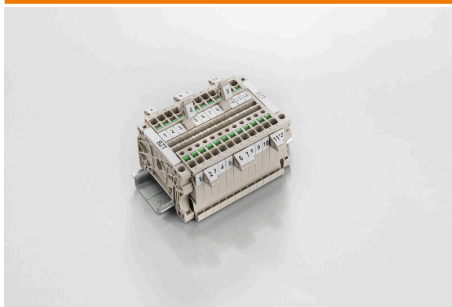

The marker holder offer the possibility of additional mounting of standard markers with a pitch of 5 or 5.1 mm. The angled holders can be optionally snapped together and could be mounted in all standard marking channels of the Klippon® Connect modular terminal blocks. Fitting marker types could be found under the respective accessories of the designation marking holder.

General ordering data

Type	BZT 1 WS 10/5	Version	
Order No.	1805490000	Accessories, Marker holder	
GTIN (EAN)	4032248270231		
Qty.	100 ST		

A4C 4 PE DL

Weidmüller Interface GmbH & Co. KG
 Klingenbergstraße 26
 D-32758 Detmold
 Germany

www.weidmueller.com

Accessories

Type	BZT 1 ZA WS 10/5	Version	
Order No.	1805520000	Accessories, Marker holder	
GTIN (EAN)	4032248270248		
Qty.	100 ST		

End plates and partition plates



Partition plates and end plates are essential accessories for terminal blocks. Partition plates provide optical and electrical separation of different potentials and functional groups, increasing safety and ensuring a clear structure inside the control cabinet. End plates close the terminal block row on the sides, protect against contact with live parts, and ensure a clean, stable finish. Both components are precisely matched to the respective Weidmüller terminal block series, contributing to safe, compliant, and professional wiring.

General ordering data

Type	APP 2	Version	
Order No.	2489090000	A-series, Partition plate	
GTIN (EAN)	4050118499308		
Qty.	50 ST		

Warning cover

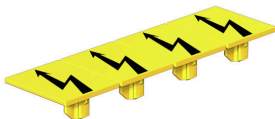

Warning covers with a flash symbol provide more safety for man and machine. They are used where external voltage must be indicated within the application.

General ordering data

Type	AAM 4 YE FLASH	Version	
Order No.	2635560000	A-series, Terminal marker, 10 x 6.1 mm, Pitch in mm (P): 6.00 yellow	
GTIN (EAN)	4050118674507		
Qty.	40 ST		

A4C 4 PE DL

Weidmüller Interface GmbH & Co. KG
 Klingenbergstraße 26
 D-32758 Detmold
 Germany

www.weidmueller.com

Accessories

End bracket

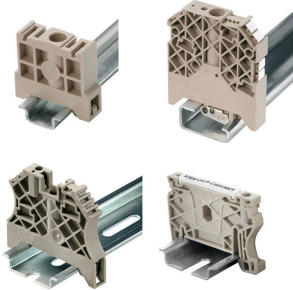

Weidmüller's range of products includes end brackets that guarantee a permanent, reliable mounting on the terminal rail and prevent sliding. Versions with and without screws are available. The end brackets include marking options, also for group markers, and also a test plug holder.

General ordering data

Type	AEB 35 SCL/1 V0	Version
Order No.	2661280000	A-series, End bracket
GTIN (EAN)	4050118702163	
Qty.	20 ST	
Type	AEB 35 SCL/1 V0 BK	Version
Order No.	2661300000	A-series, End bracket
GTIN (EAN)	4050118702187	
Qty.	20 ST	
Type	AEB 35 SCL/1 V0 GY	Version
Order No.	2661290000	A-series, End bracket
GTIN (EAN)	4050118702170	
Qty.	20 ST	

Slotted screwdriver



VDE insulated screwdriver sets, for working on live parts up to 1000 V AC and 1500 V DC, DIN EN 60900. IEC 900. Each piece is "GS" safety tested. Blade made from fully hardened, high-alloy chromium-vanadium-molybdenum steel, gun-metal finish.

General ordering data

Type	SDIS SLIM 0.6X3.5X100	Version
Order No.	2749610000	Mounting tool, Blade width (B): 3.5 mm, Blade length: 100 mm, Blade thickness (A): 0.6 mm
GTIN (EAN)	4050118896350	
Qty.	1 ST	

A4C 4 PE DL

Weidmüller Interface GmbH & Co. KG
Klingenbergstraße 26
D-32758 Detmold
Germany

www.weidmueller.com

Accessories

Testadapter and testsockets



Test adapters and test plugs are used for the electrical connection between terminal blocks and the test equipment. In this way, an electrical contact can be established in the wired state and measurements can be done easily.

General ordering data

Type	FZS 2/4 RT/80 SAKT4	Version	
Order No.	1276300000	Plug (terminal), Plug-in connection, 2 mm ² , Number of connections: 2,	
GTIN (EAN)	4008190026080	Number of poles: 1, Width: 9 mm	
Qty.	20 ST		