

## LMF 7.50/12/90 3.5SN OR BX

**Weidmüller Interface GmbH & Co. KG**  
 Klingenbergstraße 26  
 D-32758 Detmold  
 Germany

www.weidmueller.com

### Product image

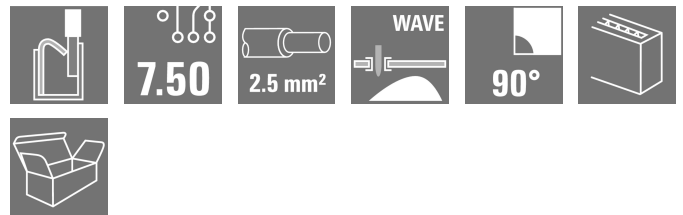
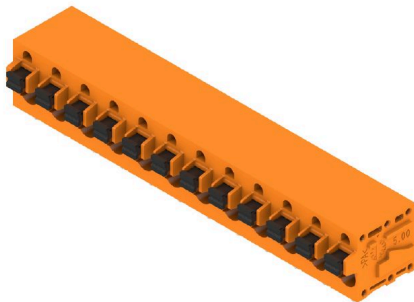

The innovative quick connector - simple, safe and economical:

PCB terminals with spring connection and direct PUSH IN technology. A milestone in connection technology.

Amazingly simple and simply amazing in practice:

- Connect and easily detach solid wires or wires with wire-end ferrules without using tools
- Processed automatically in the reflow or vapour phase
- Potentials and clamping points marked clearly by coloured push buttons

World-class design-in and processing phases, and suitable for a vast range of applications.

### General ordering data

Version	Printed circuit board terminals, 7.50 mm, Number of poles: 12, 90°, Solder pin length (l): 3.5 mm, tinned, orange, PUSH IN with push button, Clamping range, max. : 2.5 mm <sup>2</sup> , Box
Order No.	<a href="#">2668150000</a>
Type	LMF 7.50/12/90 3.5SN OR BX
GTIN (EAN)	4050118804560
Qty.	15 items
Product data	IEC: 1000 V / 24 A / 0.5 - 2.5 mm <sup>2</sup> UL: 300 V / 20 A / AWG 24 - AWG 12
Packaging	Box

## LMF 7.50/12/90 3.5SN OR BX

Weidmüller Interface GmbH & Co. KG  
Klingenbergstraße 26  
D-32758 Detmold  
Germany

www.weidmueller.com

## Technical data

## Approvals

Approvals



ROHS	Conform
UL File Number Search	<a href="#">UL Website</a>
Certificate No. (cURus)	E60693

## Dimensions and weights

Depth	19.2 mm	Depth (inches)	0.7559 inch
Height	18.3 mm	Height (inches)	0.7205 inch
Height of lowest version	14.8 mm	Width	90.2 mm
Width (inches)	3.5512 inch	Net weight	21.16 g

## Environmental Product Compliance

RoHS Compliance Status	Compliant without exemption
REACH SVHC	No SVHC above 0.1 wt%

## System parameters

Product family	OMNIMATE Signal - series LMF	Wire connection method	PUSH IN with push button
Mounting onto the PCB	THT solder connection	Conductor outlet direction	90°
Pitch in mm (P)	7.50 mm	Pitch in inches (P)	0.295 "
Number of poles	12	Number of rows	1
Solder pin length (l)	3.5 mm	Solder pin dimensions	d = 0.8 mm
Solder eyelet hole diameter (D)	1.1 mm	Solder eyelet hole diameter tolerance (D)+	0,1 mm
Number of solder pins per pole	2	Screwdriver blade	0.6 x 3.5
Screwdriver blade standard	DIN 5264	Stripping length	10 mm
L1 in mm	82.50 mm	Touch-safe protection acc. to DIN VDE 0470	IP 20
Touch-safe protection acc. to DIN VDE 57 106	Safe from finger touch	Protection degree	IP20

## Material data

Insulating material	Wemid (PA)	Colour	orange
Colour chart (similar)	RAL 2000	Comparative Tracking Index (CTI)	≥ 600
Moisture Level (MSL)		UL 94 flammability rating	V-0
Contact material	Cu-alloy	Contact surface	tinned
Coating	4-6 µm SN	Tinning type	matt
Layer structure of solder connection	4...8 µm Sn matt	Storage temperature, min.	-40 °C
Storage temperature, max.	70 °C	Operating temperature, min.	-50 °C
Operating temperature, max.	120 °C	Temperature range, installation, min.	-25 °C
Temperature range, installation, max.	120 °C		

## Conductors suitable for connection

Clamping range, min.	0.12 mm <sup>2</sup>	Clamping range, max.	2.5 mm <sup>2</sup>
Wire connection cross section AWG, min.	AWG 24	Wire connection cross section AWG, max.	AWG 12
Solid, min. H05(07) V-U	0.5 mm <sup>2</sup>	Solid, max. H05(07) V-U	2.5 mm <sup>2</sup>
Flexible, min. H05(07) V-K	0.25 mm <sup>2</sup>	Flexible, max. H05(07) V-K	2.5 mm <sup>2</sup>

**LMF 7.50/12/90 3.5SN OR BX**

**Weidmüller Interface GmbH & Co. KG**  
 Klingenbergstraße 26  
 D-32758 Detmold  
 Germany

www.weidmueller.com

**Technical data**

w. plastic collar ferrule, DIN 46228 pt 4, 0.25 mm <sup>2</sup> min.		w. plastic collar ferrule, DIN 46228 pt 4, 2.5 mm <sup>2</sup> max.
w. wire end ferrule, DIN 46228 pt 1, 0.25 mm <sup>2</sup> min.		w. wire end ferrule, DIN 46228 pt 1, 2.5 mm <sup>2</sup> max.
Reference text	Length of ferrules is to be chosen depending on the product and the rated voltage., The outside diameter of the plastic collar should not be larger than the pitch (P)	

**Rated data acc. to IEC**

tested acc. to standard	IEC 60664-1, IEC 60947-7-4	Rated current, min. number of poles (Tu=20°C)	24 A
Rated current, max. number of poles (Tu=20°C)	24 A	Rated current, min. number of poles (Tu=40°C)	24 A
Rated current, max. number of poles (Tu=40°C)	24 A	Rated voltage for surge voltage class / pollution degree II/2	1000 V
Rated voltage for surge voltage class / pollution degree III/2	600 V	Rated voltage for surge voltage class / pollution degree III/3	500 V
Rated impulse voltage for surge voltage class/ pollution degree II/2	6 kV	Rated impulse voltage for surge voltage class/ pollution degree III/2	6 kV
Rated impulse voltage for surge voltage class/ contamination degree III/3	6 kV	Short-time withstand current resistance	3 x 1s with 120 A

**Rated data acc. to CSA**

Institute (CSA)	CSA	Certificate No. (CSA)	200039-1815154
Rated voltage (Use group B / CSA)	300 V	Rated voltage (Use group D / CSA)	300 V
Rated current (Use group B / CSA)	20 A	Rated current (Use group D / CSA)	10 A
Wire cross-section, AWG, min.	AWG 24	Wire cross-section, AWG, max.	AWG 12
Reference to approval values	Specifications are maximum values, details - see approval certificate.		

**Rated data acc. to UL 1059**

Institute (cURus)	CURUS	Certificate No. (cURus)	E60693
Rated voltage (Use group B / UL 1059)	300 V	Rated voltage (Use group D / UL 1059)	300 V
Rated current (Use group B / UL 1059)	20 A	Rated current (Use group D / UL 1059)	10 A
Wire cross-section, AWG, min.	AWG 24	Wire cross-section, AWG, max.	AWG 12
Reference to approval values	Specifications are maximum values, details - see approval certificate.		

**Packing**

Packaging	Box	VPE length	350.00 mm
VPE width	138.00 mm	VPE height	31.00 mm

**Type tests**

Test: Durability of markings	Standard	IEC 61984 section 6.2 and 7.3.2 / 10.11	
	Test	mark of origin, type identification, approval marking UL, approval marking CSA, durability	
	Evaluation	available	
Test: Clampable cross section	Conductor type	Type of conductor and conductor cross-section	solid 0.2 mm <sup>2</sup>

**LMF 7.50/12/90 3.5SN OR BX**

**Weidmüller Interface GmbH & Co. KG**  
 Klingenbergstraße 26  
 D-32758 Detmold  
 Germany

www.weidmueller.com

**Technical data**

		Type of conductor and conductor cross-section	solid 2.5 mm <sup>2</sup>
		Type of conductor and conductor cross-section	stranded 0.2 mm <sup>2</sup>
		Type of conductor and conductor cross-section	flexible 4 mm <sup>2</sup>
		Type of conductor and conductor cross-section	AWG 12/7
		Type of conductor and conductor cross-section	AWG 24/11
	Evaluation	passed	
Test for damage to and accidental loosening of conductors	Standard	IEC 60999-1 section 9.4 / 11.99	
	Requirement	0.2 kg	
	Conductor type	Type of conductor and conductor cross-section	solid 0.2 mm <sup>2</sup>
		Type of conductor and conductor cross-section	stranded 0.2 mm <sup>2</sup>
	Evaluation	passed	
	Requirement	0.7 kg	
	Conductor type	Type of conductor and conductor cross-section	solid 2.5 mm <sup>2</sup>
		Evaluation	passed
	Requirement	0,9 kg	
	Pull-out test	Conductor type	Type of conductor and conductor cross-section
Evaluation			passed
Standard		IEC 60999-1 section 9.5 / 11.99	
Requirement		≥10 N	
Conductor type		Type of conductor and conductor cross-section	solid 0.2 mm <sup>2</sup>
		Type of conductor and conductor cross-section	stranded 0.2 mm <sup>2</sup>
Evaluation		passed	
Requirement		≥50 N	
Conductor type		Type of conductor and conductor cross-section	solid 2.5 mm <sup>2</sup>
		Evaluation	passed
Requirement	≥ 60 N		
Conductor type	Type of conductor and conductor cross-section	flexible 4 mm <sup>2</sup>	
	Evaluation	passed	

**Important note**

IPC conformity

Conformity: The products are developed, manufactured and delivered according international recognized standards and norms and comply with the assured properties in the data sheet resp. fulfill decorative properties in accordance with IPC-A-610 "Class 2". Further claims on the products can be evaluated on request.

Notes

- Additional variants on request
- Rated current related to rated cross-section & min. No. of poles.

## LMF 7.50/12/90 3.5SN OR BX

**Weidmüller Interface GmbH & Co. KG**  
Klingenbergstraße 26  
D-32758 Detmold  
Germany

[www.weidmueller.com](http://www.weidmueller.com)

## Technical data

- Wire end ferrule without plastic collar to DIN 46228/1
- Wire end ferrule with plastic collar to DIN 46228/4
- P on drawing = pitch
- Rated data refer only to the component itself. Clearance and creepage distances to other components are to be designed in accordance with the relevant application standards.
- The test point can only be used as potential-pickup point.
- Long term storage of the product with average temperature of 50 °C and maximum humidity 70%, 36 months

### Classifications

ETIM 6.0	EC002643	ETIM 7.0	EC002643
ETIM 8.0	EC002643	ETIM 9.0	EC002643
ETIM 10.0	EC002643	ECLASS 9.0	27-44-04-01
ECLASS 9.1	27-44-04-01	ECLASS 10.0	27-44-04-01
ECLASS 11.0	27-46-01-01	ECLASS 12.0	27-46-01-01
ECLASS 13.0	27-46-01-01	ECLASS 14.0	27-46-01-01
ECLASS 15.0	27-46-01-01		

LMF 7.50/12/90 3.5SN OR BX

Weidmüller Interface GmbH & Co. KG  
 Klingenbergstraße 26  
 D-32758 Detmold  
 Germany

www.weidmueller.com

Drawings

Product image

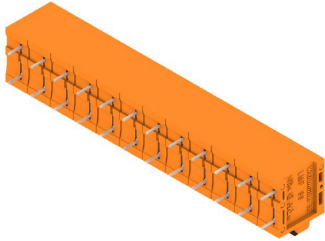

Dimensional drawing

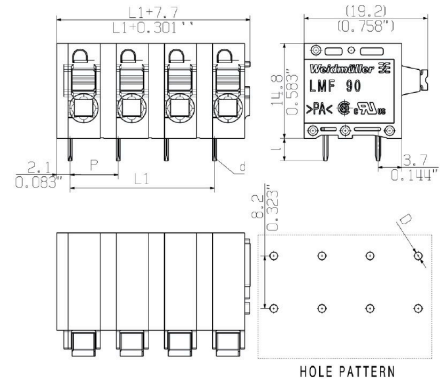

Derating curve

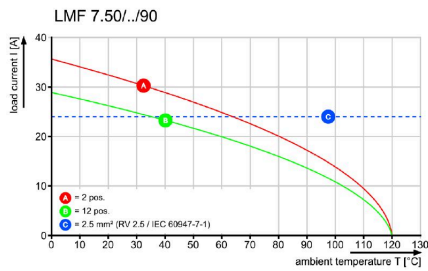

Derating curve

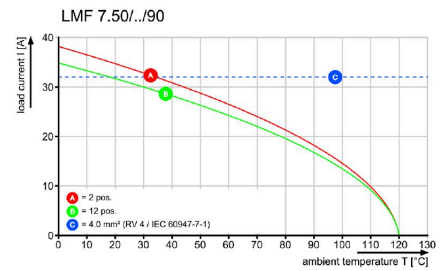

Product benefits

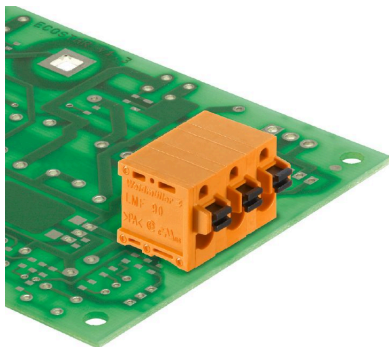

Product benefits

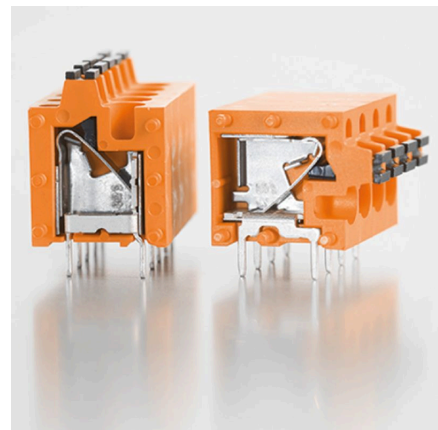

**Drawings**

**Product benefits**

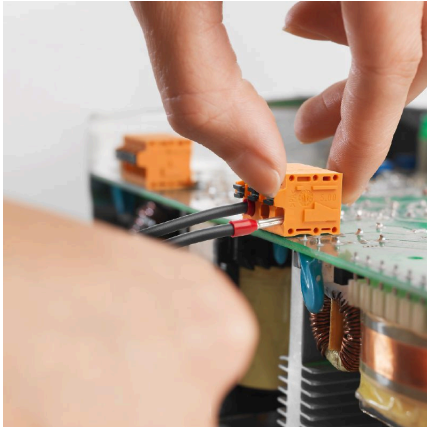

**Product benefits**



## LMF 7.50/12/90 3.5SN OR BX

**Weidmüller Interface GmbH & Co. KG**  
 Klingenbergstraße 26  
 D-32758 Detmold  
 Germany

www.weidmueller.com

## Accessories

### Slotted screwdriver

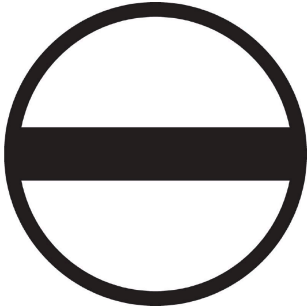

VDE insulated slot-head screwdriver, SDI DIN 7437, ISO 2380/2, drive output acc. to DIN 5264, ISO 2380/1. SoftFinish grip

#### General ordering data

Type	SDIS 0.6X3.5X100	Version	
Order No.	<a href="#">9008390000</a>	Screwdriver, Screwdriver	
GTIN (EAN)	4032248056354		
Qty.	1 ST		

### Additional accessories



No task is too small when creating the perfect solution. Connections form just one part of the overall process. Small details are often the key to the perfect solution in applications where potentials are tested, grouped or even isolated.

A system is not a system without small but essential details:

- Test plugs ensure reliable pick-up from diagnostic sockets

In tandem with the manufacturing process and application.

#### General ordering data

Type	PS 2.0 MC	Version	
Order No.	<a href="#">0310000000</a>	PCB plug-in connector, Accessories, Test plug, red, Number of poles:	
GTIN (EAN)	4008190000059		
Qty.	20 ST		1