

FP ENC BSBS 155 2M

Weidmüller Interface GmbH & Co. KG
Klingenbergstraße 26
D-32758 Detmold
Germany

www.weidmueller.com



The FieldPower® housings are highly robust and meet the highest UL flammability class 5 VA.

- The "TS 35 PT6" mounting rail module and PT6 contact unit are easy to snap on.
- Hinged seals allow pre-assembled plug cables to also be used.
- The high cover versions enable the device to be installed.

For cable seals consult accessories.

General ordering data

| | |
|------------|--|
| Version | FieldPower® enclosures, 196 mm, 196 mm, 155 mm, IP65, in complete state, glass-fibre reinforced polycarbonate, black |
| Order No. | 2659750000 |
| Type | FP ENC BSBS 155 2M |
| GTIN (EAN) | 4050118704723 |
| Qty. | 1 items |

Technical data

Approvals

Approvals



| | |
|-------------------------|----------------------------|
| ROHS | Conform |
| UL File Number Search | UL Website |
| Certificate no. (cULus) | E256877 |

Dimensions and weights

| | | | |
|------------|----------|-----------------|-------------|
| Depth | 155 mm | Depth (inches) | 6.1024 inch |
| Height | 196 mm | Height (inches) | 7.7165 inch |
| Width | 196 mm | Width (inches) | 7.7165 inch |
| Net weight | 714.16 g | | |

Temperatures

| | | | |
|---------------------|----------------|-----------------------|----------------|
| Storage temperature | -40 °C...85 °C | Operating temperature | -40 °C...85 °C |
|---------------------|----------------|-----------------------|----------------|

Environmental Product Compliance

| | |
|------------------------|--|
| RoHS Compliance Status | Compliant without exemption |
| REACH SVHC | Potassium perfluorobutane sulfonate 29420-49-3 |
| SCIP | 5f19cd84-8946-4797-9386-3ac323b95c10 |

General data

| | | | |
|-----------------------|-----------------------------|---------------------------|--------------------------------------|
| Basic material | Plastic, GRP | Enclosure material | glass-fibre reinforced polycarbonate |
| Silicone | No | Colour | black |
| Protection degree | IP65, in complete state | UL 94 flammability rating | 5VA |
| Torque for lid screws | 2 Nm | Lid attachment | TX20 screws |
| Type of mounting | Screw mounting, Fixing lugs | Installation advice | Lid screws included |

Classifications

| | | | |
|-------------|-------------|-------------|-------------|
| ETIM 8.0 | EC000261 | ETIM 9.0 | EC000261 |
| ETIM 10.0 | EC000261 | ECLASS 14.0 | 27-18-01-01 |
| ECLASS 15.0 | 27-18-01-01 | | |

FP ENC BSBS 155 2M

Weidmüller Interface GmbH & Co. KG
Klingenbergstraße 26
D-32758 Detmold
Germany

Drawings

www.weidmueller.com

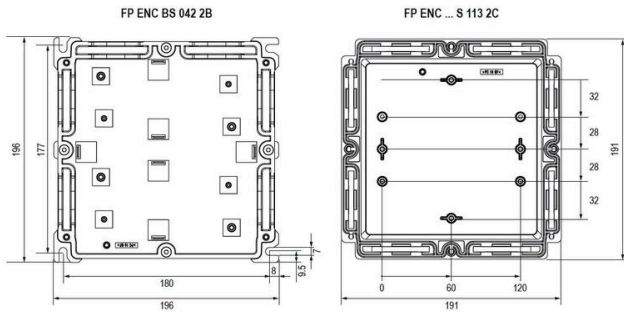

FP ENC BSBS 155 2M

Weidmüller Interface GmbH & Co. KG
 Klingenbergstraße 26
 D-32758 Detmold
 Germany

www.weidmueller.com

Accessories

Seals

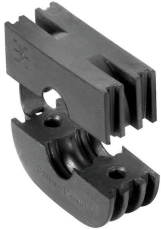

Intelligent cabling solutions can save you valuable time and money.

The FieldPower® modular system contains the right solution for every cabling task.

Foldable seals for the use of pre-assembled cables
 Seals available with M16 and M20 connection thread
 Integration of operating and signalling devices into the seal possible

General ordering data

| | | |
|------------|----------------------------|--|
| Type | DG D0 PT6 | Version |
| Order No. | 4323240000 | Field Power® sealing insert, Blank seal, IP65, with corresponding |
| GTIN (EAN) | 4032248641246 | enclosure, EPDM |
| Qty. | 10 ST | |
| Type | DG M16 PT6 | Version |
| Order No. | 2545540000 | Field Power® sealing insert, Seal with connection thread, IP65, with |
| GTIN (EAN) | 4050118555523 | corresponding enclosure, EPDM |
| Qty. | 1 ST | |
| Type | DG M20 PT6 | Version |
| Order No. | 2545550000 | Field Power® sealing insert, Seal with connection thread, IP65, with |
| GTIN (EAN) | 4050118555530 | corresponding enclosure, EPDM |
| Qty. | 1 ST | |
| Type | RKDG 2XD8.5 WG PT6 | Version |
| Order No. | 1114530000 | Field Power® sealing insert, Seal, IP54, with corresponding |
| GTIN (EAN) | 4032248892624 | enclosure, EPDM |
| Qty. | 10 ST | |
| Type | RKDG D11 PT6 | Version |
| Order No. | 4323210000 | Field Power® sealing insert, Foldable seal, IP65 with corresponding |
| GTIN (EAN) | 4032248641215 | housing, IP65, with corresponding enclosure, EPDM |
| Qty. | 10 ST | |
| Type | RKDG D13 PT6 | Version |
| Order No. | 4323230000 | Field Power® sealing insert, Foldable seal, IP65 with corresponding |
| GTIN (EAN) | 4032248641239 | housing, IP65, with corresponding enclosure, EPDM |
| Qty. | 10 ST | |
| Type | RKDG D15 PT6 | Version |
| Order No. | 4323220000 | Field Power® sealing insert, Foldable seal, IP65 with corresponding |
| GTIN (EAN) | 4032248641222 | housing, IP65, with corresponding enclosure, EPDM |
| Qty. | 10 ST | |
| Type | RKDG D17 PT6 | Version |
| Order No. | 4324010000 | Field Power® sealing insert, Foldable seal, IP65 with corresponding |
| GTIN (EAN) | 4032248641284 | housing, IP65, with corresponding enclosure, EPDM |
| Qty. | 10 ST | |
| Type | RKDG D18 WG PT6 | Version |
| Order No. | 2491870000 | Field Power® sealing insert, Seal, IP54, with corresponding |
| GTIN (EAN) | 4050118501537 | enclosure, EPDM |
| Qty. | 10 ST | |
| Type | RKDG D9 PT6 | Version |
| Order No. | 4329610000 | Field Power® sealing insert, Foldable seal, IP65 with corresponding |
| GTIN (EAN) | 4032248668687 | housing, IP65, with corresponding enclosure, EPDM |
| Qty. | 10 ST | |

FP ENC BSBS 155 2M

Weidmüller Interface GmbH & Co. KG
 Klingenbergstraße 26
 D-32758 Detmold
 Germany

www.weidmueller.com

Accessories

Adapters

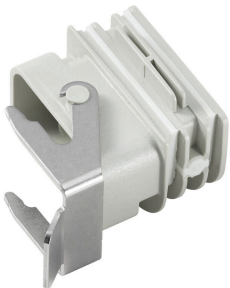

HQ adapter for FieldPower®
 Tool-free installation like a FieldPower cable seal
 Suitable for the HQ 4/2, HQ 8 and HQ 17 plug-in connector inserts
 Optionally with lockable protective cover (protection against being switched on again, in accordance with EN 60204-1)

General ordering data

| | | |
|------------|----------------------------|--|
| Type | BG ARGH HQP ALU PT6 | Version |
| Order No. | 1532200000 | Adapter, Field Power® sealing insert, HQ adapter, IP65, with corresponding enclosure, Polycarbonate, glass fibre reinforced, |
| GTIN (EAN) | 4050118337433 | lockable: No |
| Qty. | 1 ST | |
| Type | BG ARGH HQP ALU PT6 CS | Version |
| Order No. | 1532210000 | Adapter, Field Power® sealing insert, HQ adapter, IP65, with corresponding enclosure, Polycarbonate, glass fibre reinforced, |
| GTIN (EAN) | 4050118337600 | lockable: Yes |
| Qty. | 1 ST | |

AC/DC

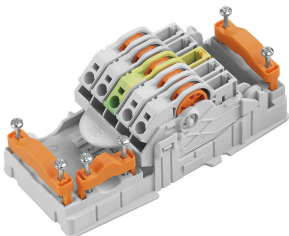

Power distribution using uncut cables with cross-sections from 1.5 to 6 mm².
 Power supply / T-branch tap via PUSH IN connection (0.5 to 10 mm²) and/or plug-in connection (0.5 to 4 mm²).
 Coloured markings provide clear assignment of wires.

- Power supply
- Power distribution
- Power branching

General ordering data

| | | |
|------------|----------------------------|--|
| Type | PT6 230/BUS | Version |
| Order No. | 1269960000 | FieldPower® contact element, AC/DC, IP20, Insulation displacement connection (IDC), PUSH IN, Number of poles : 5 |
| GTIN (EAN) | 4050118058239 | |
| Qty. | 1 ST | |

AC

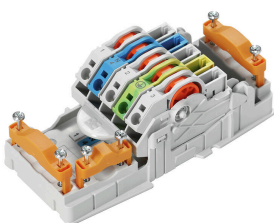

Power distribution using uncut cables with cross-sections from 1.5 to 6 mm².
 Power supply / T-branch tap via PUSH IN connection (0.5 to 10 mm²) and/or plug-in connection (0.5 to 4 mm²).
 Coloured markings provide clear assignment of wires.

- Power supply
- Power distribution
- Power branching

FP ENC BSBS 155 2M

Weidmüller Interface GmbH & Co. KG
 Klingenbergstraße 26
 D-32758 Detmold
 Germany

www.weidmueller.com

Accessories

General ordering data

| | | | |
|------------|----------------------------|---|--|
| Type | PT6 | Version | |
| Order No. | 1957620000 | FieldPower® contact element, AC, IP20, Insulation displacement connection (IDC), PUSH IN, Number of poles : 5 | |
| GTIN (EAN) | 4032248642489 | | |
| Qty. | 1 ST | | |

AC/DC

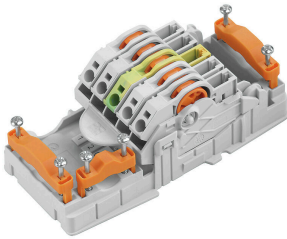

Power distribution using uncut cables with cross-sections from 1.5 to 6 mm².

Power supply / T-branch tap via PUSH IN connection (0.5 to 10 mm²) and/or plug-in connection (0.5 to 4 mm²). Coloured markings provide clear assignment of wires.

- Power supply
- Power distribution
- Power branching

General ordering data

| | | | |
|------------|----------------------------|---|--|
| Type | PT6 DC 1/2/PE/3/4 | Version | |
| Order No. | 1534930000 | FieldPower® contact element, DC, IP20, Insulation displacement connection (IDC), PUSH IN, Number of poles : 5 | |
| GTIN (EAN) | 4050118338775 | | |
| Qty. | 1 ST | | |

DC

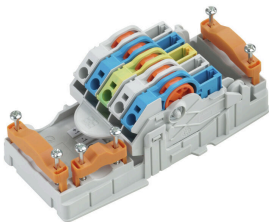

Power distribution using uncut cables with cross-sections from 1.5 to 6 mm².

Power supply / T-branch tap via PUSH IN connection (0.5 to 10 mm²) and/or plug-in connection (0.5 to 4 mm²). Coloured markings provide clear assignment of wires.

- Power supply
- Power distribution
- Power branching

General ordering data

| | | | |
|------------|----------------------------|---|--|
| Type | PT6 DC | Version | |
| Order No. | 1126840000 | FieldPower® contact element, DC, IP20, Insulation displacement connection (IDC), PUSH IN, Number of poles : 5 | |
| GTIN (EAN) | 4032248908462 | | |
| Qty. | 1 ST | | |

FP ENC BSBS 155 2M

Weidmüller Interface GmbH & Co. KG
 Klingenbergstraße 26
 D-32758 Detmold
 Germany

www.weidmueller.com

Accessories

Terminal rails for lower parts of enclosure



Extensive range of accessories for the FieldPower® boxes.
 Cable seals, terminal rails, locking elements and much more.

General ordering data

| | | | |
|------------|----------------------------|--|--|
| Type | FP ENC DR07 142 XB | Version | |
| Order No. | 2633450000 | Field Power® terminal rail, Steel, galvanized, 142 mm, for base part | |
| GTIN (EAN) | 4050118664416 | | |
| Qty. | 5 ST | | |

Terminal rails for plastic cover



Extensive range of accessories for the FieldPower® boxes.
 Cable seals, terminal rails, locking elements and much more.

General ordering data

| | | | |
|------------|----------------------------|--|--|
| Type | FP ENC DR07 142 XC P | Version | |
| Order No. | 2633510000 | Field Power® terminal rail, Steel, galvanized, 142 mm, for plastic lid | |
| GTIN (EAN) | 4050118664393 | | |
| Qty. | 5 ST | | |

Terminal rails for lower parts of enclosure



Extensive range of accessories for the FieldPower® boxes.
 Cable seals, terminal rails, locking elements and much more.

General ordering data

| | | | |
|------------|----------------------------|---|--|
| Type | TS 35 PT6 | Version | |
| Order No. | 1170690000 | Field Power® terminal rail, Steel, galvanized, 54 mm, for base part | |
| GTIN (EAN) | 4032248962532 | | |
| Qty. | 10 ST | | |

FP ENC BSBS 155 2M

Weidmüller Interface GmbH & Co. KG
 Klingenbergstraße 26
 D-32758 Detmold
 Germany

Accessories

www.weidmueller.com

IP68 version



In addition to the extensive range of enclosures, Weidmüller offers a variety of cable glands for a wide range of applications. The cable glands made of brass, plastic and stainless steel meet the most various IP protection classes to suit any industrial enclosure. Depending on the series of cable glands and the application, the cable glands are approved and tested according to VDE, UL, UR, cULus, DNV GL or EN 45545.

General ordering data

| | | |
|------------|----------------------------|---|
| Type | VG M20 - K 68 | Version |
| Order No. | 2811470000 | VG K (standard plastic cable gland), Cable glands, straight, M 20, 10 |
| GTIN (EAN) | 4064675292227 | mm, OD min. 10 - OD max. 14 mm, IP54, IP66, IP67, IP68 - 5 bar (30 |
| Qty. | 50 ST | min.), Polyamide 6 |
| Type | VG M20-1/K68 | Version |
| Order No. | 1772300000 | VG K (standard plastic cable gland), Cable glands, straight, M 20, 10 |
| GTIN (EAN) | 4032248129966 | mm, OD min. 6 - OD max. 12 mm, IP54, IP66, IP67, IP68 - 5 bar (30 |
| Qty. | 50 ST | min.), Polyamide 6 |

Plastic lock nuts, grey



In addition to cable glands for a wide range of applications, the product portfolio is rounded off by plugs, pressure compensation elements, adaptors and the corresponding accessories such as locknuts, sealing rings, flat washers and earthing rings.

General ordering data

| | | |
|------------|----------------------------|---|
| Type | SKMU M20 - K GR | Version |
| Order No. | 1772460000 | SKMU PA (plastic locknut), Locknut, M 20, 6 mm, Polyamid 6 (PA6 - |
| GTIN (EAN) | 4032248130207 | GF30) |
| Qty. | 100 ST | |

DMS PRO



Weidmüller torque screwdrivers have an ergonomic design and are therefore ideal for use with one hand. They can be used without causing fatigue in all installation positions. Apart from that, they incorporate an automatic torque limiter and have a good reproducibility accuracy.

FP ENC BSBS 155 2M

Weidmüller Interface GmbH & Co. KG

Klingenbergstraße 26

D-32758 Detmold

Germany

www.weidmueller.com

Accessories

General ordering data

| | | |
|------------|----------------------------|---------------|
| Type | DMS PRO | Version |
| Order No. | 1479120000 | Mounting tool |
| GTIN (EAN) | 4050118287011 | |
| Qty. | 1 ST | |

Bits E6,3 - Torx®



The Weidmüller bits are standard bits which are highly popular with users thanks to their good quality, large range and efficiency. The computer-controlled hardening method enables Weidmüller to guarantee a consistently high standard of quality.

The high-quality raw materials used make it possible to reach torques far higher than any of those specified in the relevant DIN standards:

- DIN 5261 for PH/PZ bits,
- DIN 5263 for slotted bits,
- Camcar standard for TORX bits

That means a long life at high torques and hence ideal conditions for standard situations.

The benefits:

- Suitable for all types of screws. Because of their excellent hardness values of 59-61 HRC, they are suitable for use with both manual and power tools.
- Good wearing resistance and thus a long life expectancy.
- Optimum fit in all DIN screws means low wear and optimum torque transmission.
- Manufactured to meet professional quality criteria according to relevant ISO standards with a consistently high standard of quality.

General ordering data

| | | |
|------------|----------------------------|---------------|
| Type | BIT E6,3 T20 X 150 | Version |
| Order No. | 2821510000 | Mounting tool |
| GTIN (EAN) | 4064675359050 | |
| Qty. | 5 ST | |

Seals

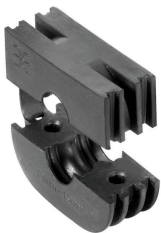

Intelligent cabling solutions can save you valuable time and money.

The FieldPower® modular system contains the right solution for every cabling task.

Foldable seals for the use of pre-assembled cables
Seals available with M16 and M20 connection thread
Integration of operating and signalling devices into the seal possible

FP ENC BSBS 155 2M

Weidmüller Interface GmbH & Co. KG
Klingenbergstraße 26
D-32758 Detmold
Germany

www.weidmueller.com

Accessories

General ordering data

| | | | |
|------------|----------------------------|---|--|
| Type | RKDG D24 WG PT6 | Version | |
| Order No. | 1069060000 | Field Power® sealing insert, Seal, IP54, with corresponding | |
| GTIN (EAN) | 4032248827053 | enclosure, EPDM | |
| Qty. | 10 ST | | |