

TRP T 24VDC 1CO M3

Weidmüller Interface GmbH & Co. KG

Klingenbergstraße 26

D-32758 Detmold

Germany

www.weidmueller.com

Product image

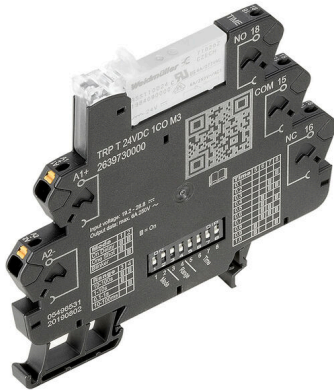

Timing relay for control signal adaptation with additional functions

Timing relays are used to coordinate fast switching processes in control systems, among other things. TERMSERIES TIMER timing relays have a on-delay, which allows for the delayed switch-on of machines, the cascaded start-up of system components or the delayed activation of consumers such as pumps or valves. They also have the One Shot and blinker functions. TERMSERIES TIMER timing relays in compact 6.4 mm terminal block format are available with either a screw connection or a PUSH IN wire connection. The timing functions and time ranges can be conveniently adjusted via the DIP switches on the side. The power supply and the respective switching status can be checked at a glance by means of the clearly visible duo LED on the ejection lever. International approvals in accordance with EN 61812 mean that they can be used anywhere in the world. TERMSERIES TIMER is compatible with the wide range of TERMSERIES accessories, thereby ensuring high levels of flexibility and simple integration into existing systems.

- Integration of additional timing functions in 6 mm TERMSERIES version
- Standard-compliant timing relays according to EN 61812
- Simple setting of timing functions and time ranges
- Integrated status LED (duo-LED in the ejection lever) for power supply and switching status

General ordering data

Version	TERMSERIES, Multifunction timing relay, Number of contacts: 1, CO contact, AgSnO, Rated control voltage: 24 V DC $\pm 20\%$, Continuous current: 6 A, PUSH IN
Order No.	2639730000
Type	TRP T 24VDC 1CO M3
GTIN (EAN)	4050118797916
Qty.	10 items

TRP T 24VDC 1CO M3

Weidmüller Interface GmbH & Co. KG
Klingenbergstraße 26
D-32758 Detmold
Germany

www.weidmueller.com

Technical data

Approvals

Approvals



ROHS	Conform
UL File Number Search	UL Website
Certificate no. (cULus)	E141197

Dimensions and weights

Depth	87.8 mm	Depth (inches)	3.4567 inch
Height	89.4 mm	Height (inches)	3.5197 inch
Width	6.4 mm	Width (inches)	0.252 inch
Net weight	31 g		

Temperatures

Storage temperature	-40 °C...85 °C	Ambient temperature	-20 °C...60 °C
Operating temperature		Humidity	5-95% relative humidity, Tu = 40°C, without condensation

Environmental Product Compliance

RoHS Compliance Status	Compliant with exemption
RoHS Exemption (if applicable/known)	7a, 7cl
REACH SVHC	Lead 7439-92-1
SCIP	9e2cbc49-76d9-4611-b8ec-5b4f549a0aa9

Rated data UL

Ambient temperature (operational), max.	60 °C	Connection cross-section AWG, min.	AWG 26
Connection cross-section AWG, max.	AWG 14	Type of conductor	rigid copper conductor, flexible copper conductor
Pollution severity level	2		

Control side

Rated control voltage	24 V DC ±20 %	Rated current DC	11.5 mA
Power rating	280 mW	Status indicator	Duo-LED orange: relay output on, Green duo-LED lit: supply voltage on, Green duo-LED flashes: incorrect configuration, no function
Protective circuit	Free-wheeling diode	Coil voltage of the replacement relay deviating from the rated control voltage	No
Coil voltage of the replacement relay	24 V DC	Time ranges	0.01 s - 0.1 s, 0.1 s - 1 s, 1 s - 10 s, 10 s - 100 s
Setting tolerance	5 %	Max. reset time after voltage interruption	50 ms
Basic accuracy	≤ 5% (of scale-end value)	Min. pulse duration	50 ms
Repeat accuracy	± 1 %		

TRP T 24VDC 1CO M3

Weidmüller Interface GmbH & Co. KG

Klingenbergstraße 26

D-32758 Detmold

Germany

www.weidmueller.com

Technical data

Load side

Rated switching voltage	250 V AC	Continuous current	6 A
Max. switching frequency at rated load	0.1 Hz	Max. switching voltage, AC	250 V
Max. switching voltage, DC	250 V	Inrush current	20 A / 20 ms
AC switching capacity (resistive), max.	1500 VA	DC switching capacity (resistive), max.	144 W @ 24 V
Contact type	1 CO contact (AgSnO)	Mechanical service life	5 x 10 ⁶ switching cycles
Min. switching power	1 mA @ 24 V, 10 mA @ 12 V, 100 mA @ 5 V		

General data

Suitable for front mounting	No	Operating altitude	≤ 2000 m, above sea level
Mounting rail	TS 35	Test button available	No
Mechanical switch position indicator	No	Colour	black
UL 94 flammability rating	V-0		

Insulation coordination

Rated voltage	250 V	Pollution severity	2
Surge voltage category	III	Clearance and creepage distances for control side - load side	≥ 6 mm
Dielectric strength for control side - load side	4 kVeff / 1 Min.	Dielectric strength of open contact	1 kVeff / 1 min
Dielectric strength to mounting rail	4 kVeff / 1 Min.	Impulse withstand voltage	6 kV (1.2/50 μs)
Protection degree	IP20		

Further details of approvals / standards

Certificate No. (DNV)	TAA00001E5	Certificate no. (cULus)	E141197
-----------------------	------------	-------------------------	---------

Connection data

Wire connection method	PUSH IN	Stripping length, rated connection	8 mm
Clamping range, rated connection	1.5 mm ²	Clamping range, min.	0.14 mm ²
Clamping range, max.	2.5 mm ²	Wire connection cross section AWG, min.	AWG 26
Wire connection cross section AWG, max.	AWG 14	Wire cross-section, solid, min.	0.14 mm ²
Wire cross-section, solid, max.	1.5 mm ²	Wire cross-section, solid, min. (AWG)	AWG 26
Wire cross-section, solid, max. (AWG)	AWG 16	Wire connection cross section, finely stranded, min.	0.14 mm ²
Wire connection cross section, finely stranded, max.	2.5 mm ²	Wire cross-section, finely stranded, min. (AWG)	AWG 26
Wire cross-section, finely stranded, max. (AWG)	AWG 14	Wire connection cross-section, finely stranded with wire-end ferrules DIN 46228/4, min.	0.14 mm ²
Wire connection cross-section, finely stranded with wire-end ferrules DIN 46228/4, max.	1.5 mm ²	Conductor cross-section, flexible, AEH (DIN 46228-1), min.	0.14 mm ²
Conductor cross-section, flexible, AEH (DIN 46228-1), max.	2.5 mm ²	Twin wire-end ferrules, min.	0.5 mm ²
Twin wire-end ferrules, max.	1 mm ²	Blade size	0.4 x 2.5 mm

Classifications

ETIM 8.0	EC001439	ETIM 9.0	EC001439
ETIM 10.0	EC001439	ECLASS 14.0	27-37-16-05
ECLASS 15.0	27-37-16-05		

TRP T 24VDC 1CO M3

Weidmüller Interface GmbH & Co. KG
 Klingenbergstraße 26
 D-32758 Detmold
 Germany

Drawings

www.weidmueller.com

Graph

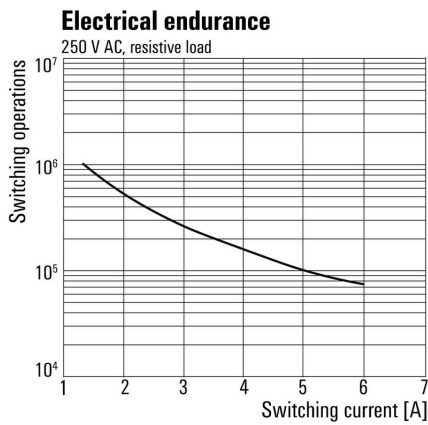

Electrical service life 230 V AC
 resistive load 230 V AC resistive load

Wiring diagram

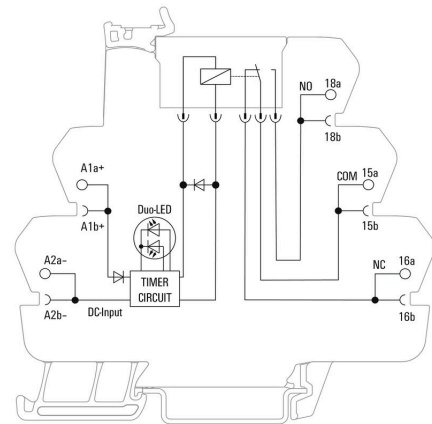

TRP T 24VDC 1CO M3

Weidmüller Interface GmbH & Co. KG
 Klingenbergstraße 26
 D-32758 Detmold
 Germany

www.weidmueller.com

Drawings

Dimensional drawing

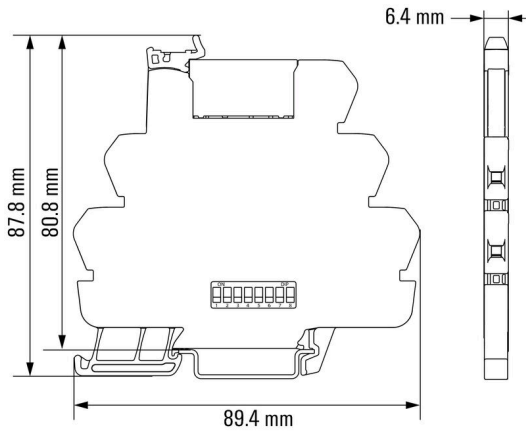

Graph

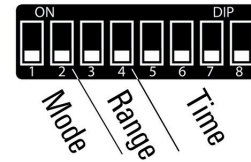

■ = On (DIP-switch turned to ON-position)

Mode	1	2
On Delay	■	■
One Shot	■	
Blinker		■
Range	3	4
10-100s	■	■
1-10s	■	
0.1-1s		■
10-100ms		

Time	5	6	7	8
0.1				
0.2				■
0.3			■	
0.4			■	■
0.5		■		
0.6		■	■	■
0.7		■	■	■
0.8		■	■	■
0.9	■			
1.0	■			■

Graph

Graph

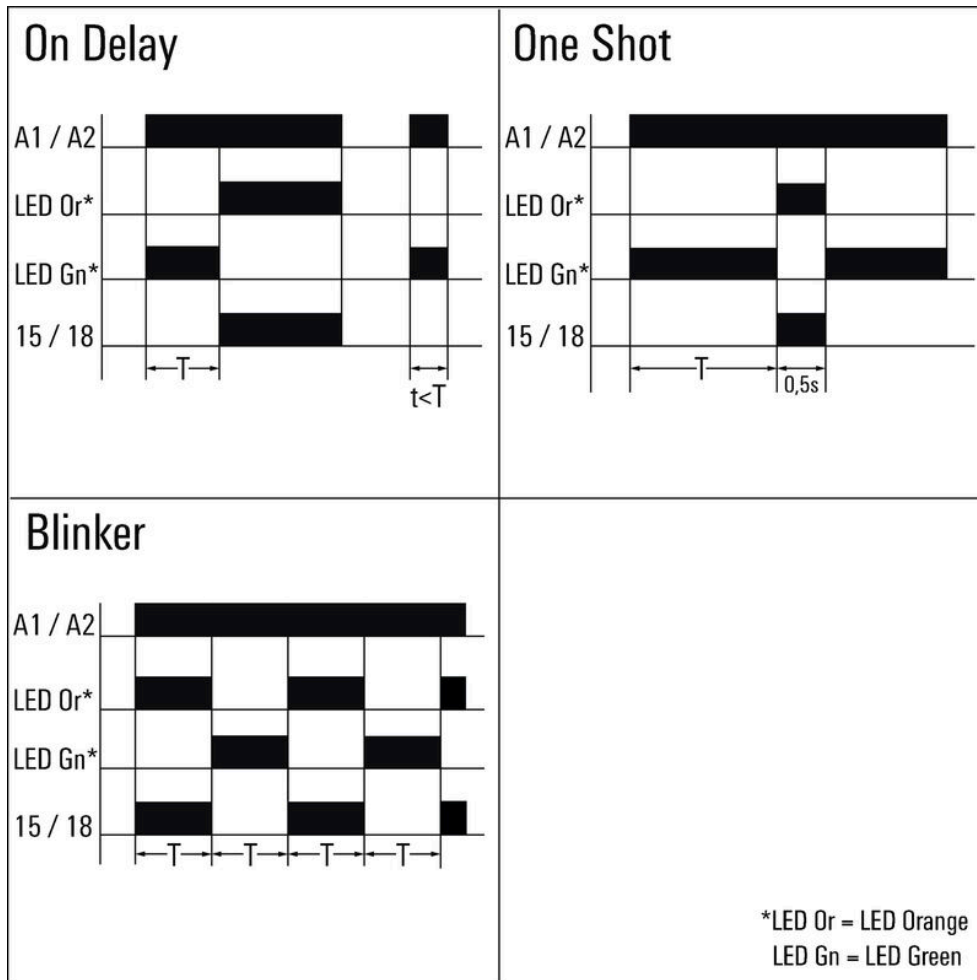

Time functions

Type codes

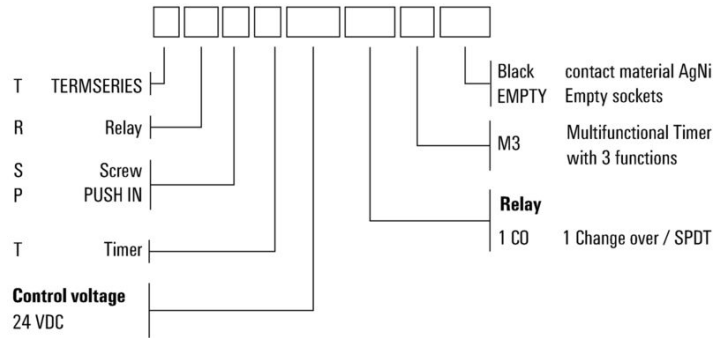

Miscellaneous