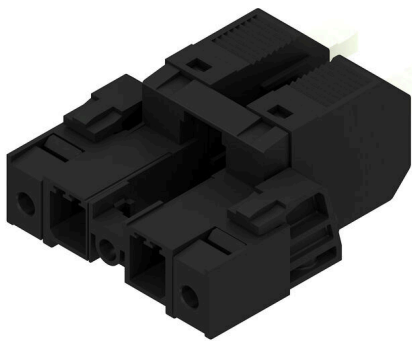

SVFL 7.62HP/02/180SFMF2 SN BK BX

Weidmüller Interface GmbH & Co. KG
 Klingenbergstraße 26
 D-32758 Detmold
 Germany

www.weidmueller.com

Product image

180° inverted pin header with PUSH IN connection technology and adjustable actuator (pusher) for field wiring 6 mm² in a 7.62 pitch. Also ideal as a touch-safe solution for inverse voltages. Meets the requirements of UL1059 600 V Class C and IEC 61800-5-1. Variants: without flange, external flange, middle flange with snap-on mechanism and optional additional screw mount.

General ordering data

Version	PCB plug-in connector, male plug, 7.62 mm, Number of poles: 2, 180°, PUSH IN with actuator, Tension-clamp connection, Box
Order No.	2630500000
Type	SVFL 7.62HP/02/180SFMF2 SN BK BX
GTIN (EAN)	4050118634143
Qty.	66 items
Product data	IEC: 1000 V / 0.5 - 6 mm ² UL: 600 V / 36 A / AWG 24 - AWG 10
Packaging	Box

SVFL 7.62HP/02/180SFMF2 SN BK BX

Weidmüller Interface GmbH & Co. KG
Klingenbergstraße 26
D-32758 Detmold
Germany

www.weidmueller.com

Technical data

Approvals

Approvals



ROHS Conform
UL File Number Search [UL Website](#)
Certificate No. (cURus) E60693

Dimensions and weights

Depth	47.7 mm	Depth (inches)	1.8779 inch
Height	23.4 mm	Height (inches)	0.9213 inch
Width	38.1 mm	Width (inches)	1.5 inch
Net weight	16.13 g		

Environmental Product Compliance

RoHS Compliance Status Compliant without exemption
REACH SVHC No SVHC above 0.1 wt%

System Parameters

Product family	OMNIMATE Power - series BV/SV 7.62HP	Type of connection	Field connection
Wire connection method	PUSH IN with actuator, Tension-clamp connection	Pitch in mm (P)	7.62 mm
Pitch in inches (P)	0.300 "	Conductor outlet direction	180°
Number of poles	2	L1 in mm	15.24 mm
L1 in inches	0.600 "	Number of rows	1
Pin series quantity	1	Touch-safe protection acc. to DIN VDE 0470	IP20 plugged
Protection degree	IP20, IP20 in installed state	Tightening torque for screw flange, min.	0.2 Nm
Tightening torque for screw flange, max.	0.3 Nm	Screwdriver blade	0.6 x 3.5
Plugging cycles	25		

Material data

Insulating material	PA GF	Colour	black
Colour chart (similar)	RAL 9011	Moisture Level (MSL)	
UL 94 flammability rating	V-0	Contact material	Cu-alloy
Contact surface	tinned	Storage temperature, min.	-40 °C
Storage temperature, max.	70 °C	Operating temperature, min.	-50 °C
Operating temperature, max.	125 °C	Temperature range, installation, min.	-25 °C
Temperature range, installation, max.	125 °C		

Conductors suitable for connection

Solid, min. H05(07) V-U	0.5 mm ²		
Solid, max. H05(07) V-U	6 mm ²		
Flexible, min. H05(07) V-K	0.5 mm ²		
Flexible, max. H05(07) V-K	6 mm ²		
w. wire end ferrule, DIN 46228 pt 1, min.	1.5 mm ²		
w. wire end ferrule, DIN 46228 pt 1, max.	6 mm ²		
Clampable conductor	Cross-section for conductor connection	Type	fine-wired

SVFL 7.62HP/02/180SFMF2 SN BK BX

Weidmüller Interface GmbH & Co. KG
 Klingenbergstraße 26
 D-32758 Detmold
 Germany

www.weidmueller.com

Technical data

wire end ferrule	nominal	2.5 mm ²
	Stripping length	nominal 12 mm
	Recommended wire-end ferrule	H2.5/12
	Stripping length	nominal 14 mm
Cross-section for conductor connection	Type	fine-wired
	nominal	4 mm ²
wire end ferrule	Stripping length	nominal 12 mm
	Recommended wire-end ferrule	H4.0/12
	Stripping length	nominal 14 mm
	Recommended wire-end ferrule	H4.0/20D GR
Cross-section for conductor connection	Type	fine-wired
	nominal	6 mm ²
wire end ferrule	Stripping length	nominal 12 mm
	Recommended wire-end ferrule	H6.0/12
	Stripping length	nominal 14 mm
	Recommended wire-end ferrule	H6.0/20 SW
Cross-section for conductor connection	Type	fine-wired
	nominal	1.5 mm ²
wire end ferrule	Stripping length	nominal 15 mm
	Recommended wire-end ferrule	H1.5/18D SW
	Stripping length	nominal 12 mm
	Recommended wire-end ferrule	H1.5/12

Reference text The outside diameter of the plastic collar should not be larger than the pitch (P), Length of ferrules is to be chosen depending on the product and the rated voltage.

Rated data acc. to IEC

Rated current, max. number of poles (Tu=20°C)	41 A	Rated current, min. number of poles (Tu=40°C)	41 A
Rated voltage for surge voltage class / pollution degree II/2	1000 V	Rated voltage for surge voltage class / pollution degree III/2	800 V
Rated impulse voltage for surge voltage class/ pollution degree II/2	6000 V	Rated impulse voltage for surge voltage class/ pollution degree III/2	8 kV
Creepage distance, min.	12.7 mm	Clearance, min.	12.7 mm

Rated data acc. to UL 1059

Institute (cURus)	CURUS	Certificate No. (cURus)	E60693
Rated voltage (Use group B / UL 1059)	600 V	Rated voltage (Use group C / UL 1059)	600 V
Rated voltage (Use group D / UL 1059)	600 V	Rated current (Use group B / UL 1059)	36 A
Rated current (Use group C / UL 1059)	36 A	Rated current (Use group D / UL 1059)	5 A
Wire cross-section, AWG, min.	AWG 24	Wire cross-section, AWG, max.	AWG 10
Reference to approval values	Specifications are maximum values, details - see approval certificate.		

Packing

Packaging	Box	VPE length	338.00 mm
VPE width	130.00 mm	VPE height	54.00 mm

SVFL 7.62HP/02/180SFMF2 SN BK BX

Weidmüller Interface GmbH & Co. KG
Klingenbergstraße 26
D-32758 Detmold
Germany

www.weidmueller.com

Technical data**Important note**

IPC conformity	Conformity: The products are developed, manufactured and delivered according international recognized standards and norms and comply with the assured properties in the data sheet resp. fulfill decorative properties in accordance with IPC-A-610 "Class 2". Further claims on the products can be evaluated on request.
Notes	<ul style="list-style-type: none">• In accordance with IEC 61984, OMNIMATE-connectors are connectors without breaking capacity (COC). During designated use, connectors are not allowed to be engaged or disengaged when live or under load• Long term storage of the product with average temperature of 50 °C and maximum humidity 70%, 36 months

Classifications

ETIM 8.0	EC002638	ETIM 9.0	EC002638
ETIM 10.0	EC002638	ECLASS 14.0	27-46-02-02
ECLASS 15.0	27-46-02-02		

SVFL 7.62HP/02/180SFMF2 SN BK BX

Weidmüller Interface GmbH & Co. KG
 Klingenbergstraße 26
 D-32758 Detmold
 Germany

www.weidmueller.com

Drawings

Product image



Dimensional drawing

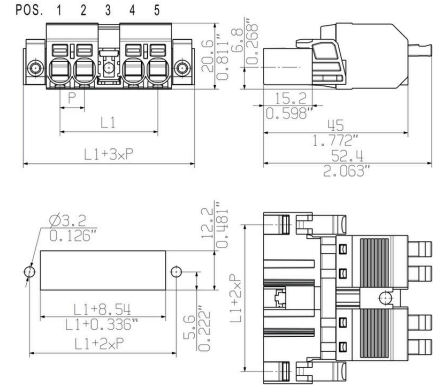

Similar to illustration

Connection diagram

6	M(S)F6	o	o	o	o	o	X	o
6	M(S)F5	o	o	o	o	X	o	o
6	M(S)F4	o	o	o	X	o	o	o
6	M(S)F3	o	o	X	o	o	o	o
6	M(S)F2	o	X	o	o	o	o	o
5	M(S)F5	o	o	o	o	X	o	
5	M(S)F4	o	o	o	X	o	o	
5	M(S)F3	o	o	X	o	o	o	
5	M(S)F2	o	X	o	o	o	o	
4	M(S)F4	o	o	o	X	o		
4	M(S)F3	o	o	X	o	o		
4	M(S)F2	o	X	o	o	o		
3	M(S)F3	o	o	X	o			
3	M(S)F2	o	X	o	o			
2	M(S)F2	o	X	o				
NO OF POLES	X = MIDDLE FLANGE POSITION	1	2	3	4	5	6	7

Similar to illustration

Product benefits

