

## BUF 10.16IT/04/180MF4 AG BK BX SO

**Weidmüller Interface GmbH & Co. KG**  
 Klingenbergstraße 26  
 D-32758 Detmold  
 Germany

www.weidmueller.com

### Product image

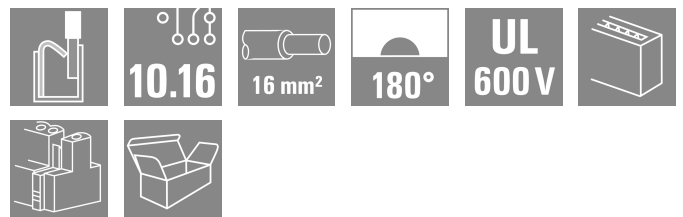
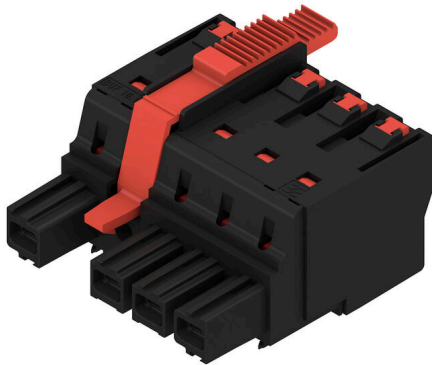

Device connectivity | OMNIMATE® Power BUF 10.16  
 PUSH IN PCB connector, 16mm<sup>2</sup>, with wire-ready function

- PUSH IN technology with settable wire-ready contact point simplifies the connection of stranded wires without wire-end ferrules and wires with particularly rigid insulation
- Direct and tool-free connection of solid wires and wires with crimped wire-end ferrules for fast and safe wiring
- Single-hand operation of the plug-in connector and automatic connection thanks to the middle flange with snap-on mechanism and optionally with additional screw fastening

### General ordering data

Version	PCB plug-in connector, female plug, 10.16 mm, Number of poles: 4, 180°, PUSH IN with actuator, Clamping range, max. : 16 mm <sup>2</sup> , Box
Order No.	<a href="#">2592540000</a>
Type	BUF 10.16IT/04/180MF4 AG BK BX SO
GTIN (EAN)	4050118603712
Qty.	24 items
Product data	IEC: 1000 V / 76 A / 2.5 - 16 mm <sup>2</sup> UL: 600 V / 51 A / AWG 12 - AWG 6
Packaging	Box

## BUF 10.16IT/04/180MF4 AG BK BX SO

Weidmüller Interface GmbH & Co. KG  
Klingenbergstraße 26  
D-32758 Detmold  
Germany

www.weidmueller.com

## Technical data

## Approvals

Approvals



UL File Number Search [UL Website](#)  
Certificate No. (cURus) E60693

## Dimensions and weights

Depth	39.5 mm	Depth (inches)	1.5551 inch
Height	33.3 mm	Height (inches)	1.311 inch
Width	50.8 mm	Width (inches)	2 inch
Net weight	10.1 g		

## Environmental Product Compliance

RoHS Compliance Status Compliant without exemption  
REACH SVHC No SVHC above 0.1 wt%

## System Parameters

Product family	OMNIMATE Power - series BU/SU 10.16	Type of connection	Field connection
Wire connection method	PUSH IN with actuator	Pitch in mm (P)	10.16 mm
Pitch in inches (P)	0.400 "	Conductor outlet direction	180°
Number of poles	4	L1 in mm	40.64 mm
L1 in inches	1.600 "	Number of rows	1
Pin series quantity	1	Rated cross-section	16 mm <sup>2</sup>
Touch-safe protection acc. to DIN VDE 57 106	Safe from finger touch	Touch-safe protection acc. to DIN VDE 0470	IP 20
Protection degree	IP20	Can be coded	Yes
Stripping length	18 mm	Screwdriver blade	0.8 x 4.0
Screwdriver blade standard	DIN 5264	Plugging cycles	25
Plugging force/pole, max.	15 N	Pulling force/pole, max.	15 N

## Material data

Insulating material	PA GF	Colour	black
Colour of operational elements	red, grey	Colour chart (similar)	RAL 9011
Insulating material group	II	Comparative Tracking Index (CTI)	≥ 400
Insulation resistance	≥ 10 <sup>8</sup> Ω	Moisture Level (MSL)	
UL 94 flammability rating	V-0	Contact material	Cu-alloy
Contact surface	silver-plated	Layer structure of plug contact	≥ 3 μm Ag
Storage temperature, min.	-40 °C	Storage temperature, max.	70 °C
Operating temperature, min.	-50 °C	Operating temperature, max.	120 °C

## Conductors suitable for connection

Clamping range, min.	2.5 mm <sup>2</sup>
Clamping range, max.	16 mm <sup>2</sup>
Wire connection cross section AWG, min.	AWG 12
Wire connection cross section AWG, max.	AWG 4
Solid, min. H05(07) V-U	2.5 mm <sup>2</sup>
Solid, max. H05(07) V-U	10 mm <sup>2</sup>
Stranded, min. H07V-R	10 mm <sup>2</sup>

Creation date 24.02.2026 05:41:04 MEZ

Catalogue status / Drawings

## BUF 10.16IT/04/180MF4 AG BK BX SO

**Weidmüller Interface GmbH & Co. KG**  
 Klingenbergstraße 26  
 D-32758 Detmold  
 Germany

www.weidmueller.com

## Technical data

Stranded, max. H07V-R	16 mm <sup>2</sup>
Flexible, min. H05(07) V-K	2.5 mm <sup>2</sup>
Flexible, max. H05(07) V-K	16 mm <sup>2</sup>
w. plastic collar ferrule, DIN 46228 pt 4, 2.5 mm <sup>2</sup> min.	
w. plastic collar ferrule, DIN 46228 pt 4, 16 mm <sup>2</sup> max.	
w. wire end ferrule, DIN 46228 pt 1, 2.5 mm <sup>2</sup> min.	
w. wire end ferrule, DIN 46228 pt 1, 16 mm <sup>2</sup> max.	

Clampable conductor	Cross-section for conductor connection	Type	fine-wired
		nominal	2.5 mm <sup>2</sup>
wire end ferrule	wire end ferrule	Stripping length	nominal 20 mm
		Recommended wire-end ferrule	<a href="#">H2,5/25D BL</a>
		Stripping length	nominal 18 mm
		Recommended wire-end ferrule	<a href="#">H2,5/18</a>
Cross-section for conductor connection	wire end ferrule	Type	fine-wired
		nominal	4 mm <sup>2</sup>
		Stripping length	nominal 20 mm
		Recommended wire-end ferrule	<a href="#">H4,0/26D GR</a>
Cross-section for conductor connection	wire end ferrule	Type	fine-wired
		nominal	6 mm <sup>2</sup>
		Stripping length	nominal 20 mm
		Recommended wire-end ferrule	<a href="#">H6,0/26 SW</a>
Cross-section for conductor connection	wire end ferrule	Type	fine-wired
		nominal	10 mm <sup>2</sup>
		Stripping length	nominal 21 mm
		Recommended wire-end ferrule	<a href="#">H10,0/28 EB</a>
Cross-section for conductor connection	wire end ferrule	Type	fine-wired
		nominal	16 mm <sup>2</sup>
		Stripping length	nominal 21 mm
		Recommended wire-end ferrule	<a href="#">H16,0/28 GN</a>
Cross-section for conductor connection	wire end ferrule	Type	fine-wired
		nominal	16 mm <sup>2</sup>
		Stripping length	nominal 18 mm
		Recommended wire-end ferrule	<a href="#">H16,0/18</a>

Reference text Length of ferrules is to be chosen depending on the product and the rated voltage.

### Rated data acc. to IEC

Rated current, min. number of poles (Tu=20°C)	76 A	Rated current, max. number of poles (Tu=20°C)	71 A
Rated current, min. number of poles (Tu=40°C)	70 A	Rated current, max. number of poles (Tu=40°C)	62 A

## BUF 10.16IT/04/180MF4 AG BK BX SO

**Weidmüller Interface GmbH & Co. KG**  
 Klingenbergstraße 26  
 D-32758 Detmold  
 Germany

www.weidmueller.com

## Technical data

Rated voltage for surge voltage class / pollution degree II/2	1000 V	Rated voltage for surge voltage class / pollution degree III/2	1000 V
Rated voltage for surge voltage class / pollution degree III/3	1000 V	Rated impulse voltage for surge voltage class/ pollution degree II/2	8 kV
Rated impulse voltage for surge voltage class/ pollution degree III/2	8 kV	Rated impulse voltage for surge voltage class/ contamination degree III/3	8 kV
Short-time withstand current resistance	3 x 1s with 800A		

### Rated data acc. to UL 1059

Institute (cURus)	CURUS	Certificate No. (cURus)	E60693
Rated voltage (Use group B / UL 1059)	600 V	Rated voltage (Use group C / UL 1059)	600 V
Rated current (Use group B / UL 1059)	51 A	Rated current (Use group C / UL 1059)	51 A
Wire cross-section, AWG, min.	AWG 12	Wire cross-section, AWG, max.	AWG 6
Reference to approval values	Specifications are maximum values, details - see approval certificate.		

### Packing

Packaging	Box	VPE length	165.00 mm
VPE width	365.00 mm	VPE height	105.00 mm

### Type tests

Test: Durability of markings	Standard	IEC 60068-2-70 / 12.95		
	Test	mark of origin, type identification, pitch, durability, stripping length		
	Evaluation	available		
Test: Clampable cross section	Standard	IEC 60999-1:1999-11 section 9.1, IEC 60947-1:2011-03 section 8.2.4.5.1		
	Conductor type	Type of conductor and conductor cross-section	stranded 2.5 mm <sup>2</sup>	
		Type of conductor and conductor cross-section	solid 2.5 mm <sup>2</sup>	
		Type of conductor and conductor cross-section	stranded 16 mm <sup>2</sup>	
		Type of conductor and conductor cross-section	solid 10 mm <sup>2</sup>	
		Type of conductor and conductor cross-section	AWG 12/1	
		Type of conductor and conductor cross-section	AWG 12/19	
		Type of conductor and conductor cross-section	AWG 4/1	
		Type of conductor and conductor cross-section	AWG 4/19	
Evaluation	passed			
Test for damage to and accidental loosening of conductors	Standard	IEC 60999-1:1999-11 section 9.4 bzw. section 8.10		
	Requirement	0.7 kg		
	Conductor type	Type of conductor and conductor cross-section	H07V-K2.5	

**BUF 10.16IT/04/180MF4 AG BK BX SO**

**Weidmüller Interface GmbH & Co. KG**  
 Klingenbergstraße 26  
 D-32758 Detmold  
 Germany

www.weidmueller.com

**Technical data**

		Type of conductor and conductor cross-section	H07V-U2.5
		Type of conductor and conductor cross-section	AWG 14/1
		Type of conductor and conductor cross-section	AWG 14/19
	Evaluation	passed	
	Requirement	2.9 kg	
	Conductor type	Type of conductor and conductor cross-section	H07V-K16
		Type of conductor and conductor cross-section	H07V-U16
	Evaluation	passed	
	Requirement	4,5 kg	
	Conductor type	Type of conductor and conductor cross-section	AWG 4/7
		Type of conductor and conductor cross-section	AWG 4/19
Pull-out test	Standard	IEC 60999-1:1999-11 section 9.5	
	Requirement	≥50 N	
	Conductor type	Type of conductor and conductor cross-section	AWG 14/1
		Type of conductor and conductor cross-section	AWG 14/19
		Type of conductor and conductor cross-section	H07V-K2.5
		Type of conductor and conductor cross-section	H07V-U2.5
	Evaluation	passed	
	Requirement	≥100 N	
	Conductor type	Type of conductor and conductor cross-section	H07V-K16
		Type of conductor and conductor cross-section	H07V-U16
	Evaluation	passed	
	Requirement	≥ 135 N	
	Conductor type	Type of conductor and conductor cross-section	AWG 4/7
		Type of conductor and conductor cross-section	AWG4/19
	Evaluation	passed	

**Important note**

IPC conformity

Conformity: The products are developed, manufactured and delivered according international recognized standards and norms and comply with the assured properties in the data sheet resp. fulfill decorative properties in accordance with IPC-A-610 "Class 2". Further claims on the products can be evaluated on request.

## BUF 10.16IT/04/180MF4 AG BK BX SO

**Weidmüller Interface GmbH & Co. KG**  
Klingenbergstraße 26  
D-32758 Detmold  
Germany

[www.weidmueller.com](http://www.weidmueller.com)

## Technical data

### Notes

- Additional variants on request
- Rated current related to rated cross-section & min. No. of poles.
- Wire end ferrule with plastic collar to DIN 46228/4
- Wire end ferrule without plastic collar to DIN 46228/1
- P on drawing = pitch
- Rated data refer only to the component itself. Clearance and creepage distances to other components are to be designed in accordance with the relevant application standards.
- For all applications with flange we recommend to fix the pin header with the help of the soldering flange or a self-tapping screw on the board.
- In accordance with IEC 61984, OMNIMATE-connectors are connectors without breaking capacity (COC). During designated use, connectors are not allowed to be engaged or disengaged when live or under load
- Long term storage of the product with average temperature of 50 °C and maximum humidity 70%, 36 months

### Classifications

ETIM 8.0	EC002638	ETIM 9.0	EC002638
ETIM 10.0	EC002638	ECLASS 14.0	27-46-02-02
ECLASS 15.0	27-46-02-02		

BUF 10.16IT/04/180MF4 AG BK BX SO

Weidmüller Interface GmbH & Co. KG  
 Klingenbergstraße 26  
 D-32758 Detmold  
 Germany

www.weidmueller.com

Drawings

Product image

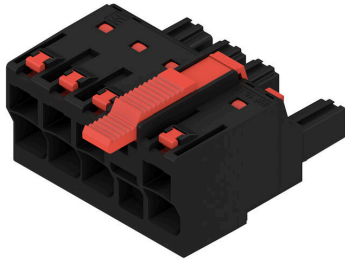

Dimensional drawing

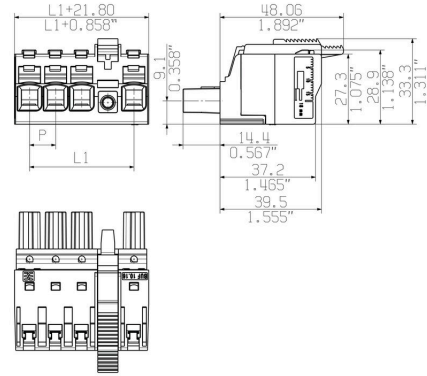

Similar to illustration

Connection diagram

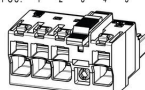
4	M(S)F4	o	o	o	X	o
4	M(S)F3	o	o	X	o	o
4	M(S)F2	o	X	o	o	o
3	M(S)F3	o	o	X	o	
3	M(S)F2	o	X	o	o	
2	M(S)F2	o	X	o		
NO OF POLES	X = MIDDLE FLANGE POSITION	1	2	3	4	5
						

Graph

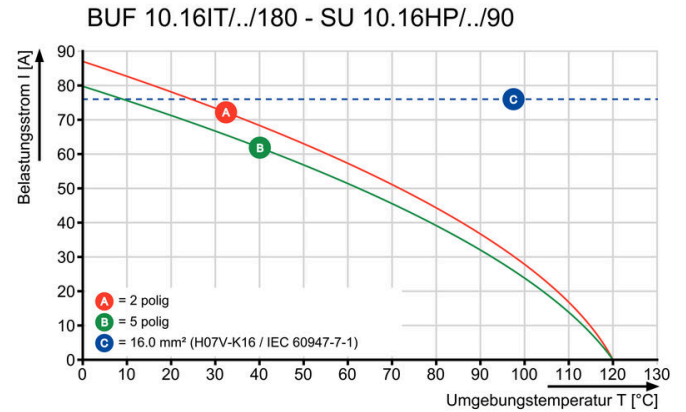

Graph

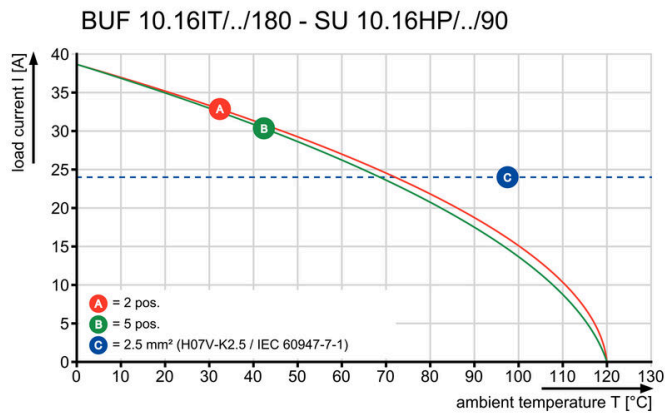

Easy connection of conductors WIRE READY

Product benefits



Easy connection of conductors WIRE READY

**Product benefits**



Quick wiring

**Product benefits**

