

WFS 4 100-250V**Weidmüller Interface GmbH & Co. KG**

Klingenbergstraße 26

D-32758 Detmold

Germany

www.weidmueller.com

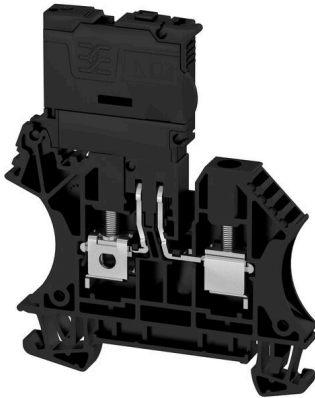
Product image

Fuse terminal blocks and component terminal blocks allow protective and functional elements to be integrated directly into the terminal strip. Fuse terminal blocks include built-in fuse holders to reliably protect electrical circuits against overload –ideal for control and distribution systems. Component terminal blocks make it possible to incorporate electronic components such as diodes, resistors, or LEDs directly into the wiring. This enables space-saving and clearly arranged implementation of switching functions and signal separation. Both types of terminal blocks ensure higher safety, easy maintenance, and a compact, function-oriented installation.

General ordering data

Version	Fuse terminal, Screw connection, black, 4 mm ² , 6.3 A, 250 V, Number of connections: 2, Number of levels: 1, TS 35
Order No.	2561960000
Type	WFS 4 100-250V
GTIN (EAN)	4050118570434
Qty.	50 items

WFS 4 100-250V

Weidmüller Interface GmbH & Co. KG
Klingenbergstraße 26
D-32758 Detmold
Germany

www.weidmueller.com

Technical data

Approvals

Approvals



ROHS	Conform
UL File Number Search	UL Website
Certificate No. (cURus)	E60693
Certificate No. (cURusEX)	E184763

Dimensions and weights

Depth	75 mm	Depth (inches)	2.9527 inch
Depth including DIN rail	75.5 mm	Height	62.5 mm
Height (inches)	2.4606 inch	Width	6.1 mm
Width (inches)	0.2402 inch	Net weight	17.69 g

Temperatures

Storage temperature	-25 °C...55 °C	Ambient temperature	-60 °C...85 °C
Continuous operating temp., min.	-60 °C	Continuous operating temp., max.	130 °C

Environmental Product Compliance

RoHS Compliance Status	Compliant without exemption
REACH SVHC	No SVHC above 0.1 wt%

Material data

Basic material	Wemid	Colour	black
UL 94 flammability rating	V-0		

Rating data IECEx/ATEX

Certificate No. (ATEX)	TÜV20ATEX8502U	Certificate No. (IECEX)	IECEXTUR20.0014U
Wire cross section max. (ATEX)	6 mm ²	Wire cross section max. (IECEX)	6 mm ²

System specifications

Version	Screw connection, Fuse isolator	End cover plate required	Yes
Number of potentials	1	Number of levels	1
Number of clamping points per level	2	Number of potentials per tier	1
Levels cross-connected internally	No	PE connection	No
Mounting rail	TS 35	N-function	No
PE function	No	PEN function	No

Additional technical data

Open sides	right	Type of mounting	Snap-on
------------	-------	------------------	---------

WFS 4 100-250V

Weidmüller Interface GmbH & Co. KG

Klingenbergstraße 26
D-32758 Detmold
Germany

www.weidmueller.com

Technical data

CSA rating data

Wire cross section max. (CSA)	10 AWG	Certificate No. (CSA)	200039-1057876
Voltage size B (CSA)	300 V	Current size B (CSA)	10 A
Voltage size D (CSA)	300 V	Current size D (CSA)	10 A
Wire cross section min. (CSA)	22 AWG		

Conductors for clamping (additional connection)

Connection type, additional connection Screw connection

Conductors for clamping (rated connection)

Gauge to IEC 60947-1	A4	
Wire connection cross section AWG, max.	AWG 10	
Connection direction	on side	
Tightening torque, max.	0.6 Nm	
Tightening torque, min.	0.5 Nm	
Stripping length	13 mm	
Type of connection 2	Screw connection	
Type of connection	Screw connection	
Number of connections	2	
Clamping range, max.	6 mm ²	
Clamping range, min.	0.22 mm ²	
Clamping screw	M 3	
Blade size	0.6 x 3.5 mm	
Wire connection cross section AWG, min.	AWG 26	
Wire connection cross-section, finely stranded with wire-end ferrules DIN 46228/4, max.	4 mm ²	
Wire connection cross-section, finely stranded with wire-end ferrules DIN 46228/4, min.	0.22 mm ²	
Wire connection cross-section, finely stranded with wire-end ferrules DIN 46228/1, max.	4 mm ²	
Wire connection cross-section, finely stranded with wire-end ferrules DIN 46228/1, min.	0.22 mm ²	
Wire connection cross section, finely stranded, max.	4 mm ²	
Wire connection cross section, finely stranded, min.	0.22 mm ²	
Connection cross-section, stranded, max.	6 mm ²	
Connection cross-section, stranded, min.	0.22 mm ²	
Torque level with DMS electric screwdriver	2	
Wire connection cross-section, solid core, max.	6 mm ²	
Wire connection cross-section, solid core, min.	0.22 mm ²	
Connection cross-section, finely stranded, min.	0.22 mm ²	
Clampable conductor	Connection specification	
	Cross-section for conductor connection	
	Screw connection	
	Type	solid, H05(07) V-U
min.	0.5 mm ²	
max.	6 mm ²	

WFS 4 100-250V

Weidmüller Interface GmbH & Co. KG

Klingenbergstraße 26
D-32758 Detmold
Germany

www.weidmueller.com

Technical data

wire end ferrule	nominal	4 mm ²	
		Stripping length	min. 13 mm
			max. 13 mm
	Tightening torque	nominal 13 mm	
min. 0.5 Nm			
		max. 0.6 Nm	
Connection specification		Screw connection	
Cross-section for conductor connection	Type	stranded, H07V-R	
	min.	1.5 mm ²	
	max.	6 mm ²	
	nominal	4 mm ²	
wire end ferrule	Stripping length	min. 13 mm	
		max. 13 mm	
		nominal 13 mm	
	Tightening torque	min. 0.5 Nm	
max. 0.6 Nm			
Connection specification		Screw connection	
Cross-section for conductor connection	Type	flexible, H05(07) V-K	
	min.	0.5 mm ²	
	max.	4 mm ²	
	nominal	4 mm ²	
wire end ferrule	Stripping length	min. 13 mm	
		max. 13 mm	
		nominal 13 mm	
	Tightening torque	min. 0.5 Nm	
max. 0.6 Nm			

Fuse terminals

Cartridge fuse	G-Si. 5 x 20	Fuse holder (cartridge holder)	Pivoting
Type of voltage for indicator	AC/DC	Current	6.3 A
Display	LED	Operating voltage, max.	250 V
Power loss, 1-pole ; 2-pole ; 3-pole		Permitted power loss for fuse with semiconductor protection	
Leakage current, max.	0.5 mA		

General

Wire connection cross section AWG, max.	AWG 10	Wire connection cross section AWG, min.	AWG 26
Standards	IEC 60947-7-3	Mounting rail	TS 35

Rating data

Rated cross-section	4 mm ²	Rated voltage	250 V
Rated voltage to adjoining terminal	400 V	Rated DC voltage	250 V
Nominal current	6.3 A	Current at maximum wires	6.3 A
Standards	IEC 60947-7-3	Volume resistance according to IEC 60947-7-x	1 mΩ
Rated impulse withstand voltage	6 kV	Power loss in accordance with IEC 60947-7-x	1.02 W
Pollution severity	3		

UL rating data

Conductor size Factory wiring max. (cURus)	10 AWG	Voltage size B (cURus)	300 V
Voltage size D (cURus)	300 V	Certificate No. (cURus)	E60693

WFS 4 100-250V

Weidmüller Interface GmbH & Co. KG
Klingenbergstraße 26
D-32758 Detmold
Germany

www.weidmueller.com

Technical data

Conductor size Field wiring min. (cURus) 22 AWG	Conductor size Factory wiring min. (cURus) 22 AWG
Current size B (cURus) 10 A	Current size D (cURus) 10 A
Conductor size Field wiring max. (cURus) 10 AWG	

Important note

Product information The voltage depends on the selected fuse element or the selected indicator light

Classifications

ETIM 8.0	EC000899	ETIM 9.0	EC000899
ETIM 10.0	EC000899	ECLASS 14.0	27-25-01-13
ECLASS 15.0	27-25-01-13		

Drawings



Accessories

End plates and partition plates



Partition plates and end plates are essential accessories for terminal blocks. Partition plates provide optical and electrical separation of different potentials and functional groups, increasing safety and ensuring a clear structure inside the control cabinet. End plates close the terminal block row on the sides, protect against contact with live parts, and ensure a clean, stable finish. Both components are precisely matched to the respective Weidmüller terminal block series, contributing to safe, compliant, and professional wiring.

General ordering data

Type	WAP 2.5-10	Version
Order No.	1050000000	End plate for terminals, dark beige, Height: 56 mm, Width: 1.5 mm,
GTIN (EAN)	4008190103149	V-0, Wemid, Snap-on: No
Qty.	50 ST	
Type	WAP 2.5-10 BL	Version
Order No.	1050080000	End plate for terminals, blue, Height: 56 mm, Width: 1.5 mm, V-0,
GTIN (EAN)	4008190136611	Wemid, Snap-on: No
Qty.	50 ST	
Type	WAP 2.5-10 BR	Version
Order No.	1050070000	End plate for terminals, brown, Height: 56 mm, Width: 1.5 mm, V-0,
GTIN (EAN)	4008190455507	Wemid, Snap-on: No
Qty.	50 ST	
Type	WAP 2.5-10 GE	Version
Order No.	1050020000	End plate for terminals, yellow, Height: 56 mm, Width: 1.5 mm, V-0,
GTIN (EAN)	4008190406776	Wemid, Snap-on: No
Qty.	50 ST	
Type	WAP 2.5-10 GN	Version
Order No.	1072200000	End plate for terminals, green, Height: 56 mm, Width: 1.5 mm, V-0,
GTIN (EAN)	4008190455491	Wemid, Snap-on: No
Qty.	50 ST	
Type	WAP 2.5-10 GR	Version
Order No.	1050050000	End plate for terminals, grey, Height: 56 mm, Width: 1.5 mm, V-0,
GTIN (EAN)	4008190455484	Wemid, Snap-on: No
Qty.	50 ST	
Type	WAP 2.5-10 OR	Version
Order No.	1050060000	End plate for terminals, orange, Height: 56 mm, Width: 1.5 mm, V-0,
GTIN (EAN)	4008190406769	Wemid, Snap-on: No
Qty.	50 ST	
Type	WAP 2.5-10 RT	Version
Order No.	1050040000	End plate for terminals, red, Height: 56 mm, Width: 1.5 mm, V-0,
GTIN (EAN)	4008190406783	Wemid, Snap-on: No
Qty.	50 ST	
Type	WAP 2.5-10 SW	Version
Order No.	1050010000	End plate for terminals, black, Height: 56 mm, Width: 1.5 mm, V-0,
GTIN (EAN)	4008190406806	Wemid, Snap-on: No
Qty.	50 ST	
Type	WAP 2.5-10 VI	Version
Order No.	1072210000	End plate for terminals, violet, Height: 56 mm, Width: 1.5 mm, V-0,
GTIN (EAN)	4008190455460	Wemid, Snap-on: No
Qty.	50 ST	

WFS 4 100-250V

Weidmüller Interface GmbH & Co. KG
 Klingenbergstraße 26
 D-32758 Detmold
 Germany

www.weidmueller.com

Accessories

Type	WAP 2.5-10 WS	Version
Order No.	1050090000	End plate for terminals, white, Height: 56 mm, Width: 1.5 mm, V-0,
GTIN (EAN)	4008190406790	Wemid, Snap-on: No
Qty.	50 ST	

Cross-connections



The distribution or multiplication of a potential to adjoining terminal blocks is realized via a cross-connection. Additional wiring effort can be easily avoided. Even if the poles are broken out, contact reliability in the terminal blocks is still ensured. Our portfolio offers pluggable and screwable cross-connection systems for modular terminal blocks.

General ordering data

Type	ZQV 4N/10 RD	Version
Order No.	2460740000	Cross-connector (terminal), Plugged, red, 32 A, Number of poles: 10,
GTIN (EAN)	4050118476163	Pitch in mm (P): 6.10, Insulated: Yes, Width: 58.7 mm
Qty.	20 ST	
Type	ZQV 4N/2	Version
Order No.	1527930000	Cross-connector (terminal), Plugged, orange, 32 A, Number of poles: 2,
GTIN (EAN)	4050118332766	Pitch in mm (P): 6.10, Insulated: Yes, Width: 9.9 mm
Qty.	60 ST	
Type	ZQV 4N/2 BL	Version
Order No.	1528040000	Cross-connector (terminal), Plugged, blue, 32 A, Number of poles: 2,
GTIN (EAN)	4050118332773	Pitch in mm (P): 6.10, Insulated: Yes, Width: 9.9 mm
Qty.	60 ST	
Type	ZQV 4N/2 RD	Version
Order No.	2460450000	Cross-connector (terminal), Plugged, red, 32 A, Number of poles: 2,
GTIN (EAN)	4050118476149	Pitch in mm (P): 6.10, Insulated: Yes, Width: 9.9 mm
Qty.	60 ST	
Type	ZQV 4N/3	Version
Order No.	1527940000	Cross-connector (terminal), Plugged, orange, 32 A, Number of poles: 3,
GTIN (EAN)	4050118332865	Pitch in mm (P): 6.10, Insulated: Yes, Width: 16 mm
Qty.	60 ST	
Type	ZQV 4N/3 BL	Version
Order No.	1528080000	Cross-connector (terminal), Plugged, blue, 32 A, Number of poles: 3,
GTIN (EAN)	4050118333008	Pitch in mm (P): 6.10, Insulated: Yes, Width: 16 mm
Qty.	60 ST	
Type	ZQV 4N/10	Version
Order No.	1528090000	Cross-connector (terminal), Plugged, orange, 32 A, Number of poles: 10,
GTIN (EAN)	4050118332896	Pitch in mm (P): 6.10, Insulated: Yes, Width: 58.7 mm
Qty.	20 ST	
Type	ZQV 4N/10 BL	Version
Order No.	1528230000	Cross-connector (terminal), Plugged, blue, 32 A, Number of poles: 10,
GTIN (EAN)	4050118333138	Pitch in mm (P): 6.10, Insulated: Yes, Width: 58.7 mm
Qty.	20 ST	

WFS 4 100-250V

Weidmüller Interface GmbH & Co. KG
 Klingenbergstraße 26
 D-32758 Detmold
 Germany

www.weidmueller.com

Accessories

Type	ZQV 4N/3 RD	Version
Order No.	2460810000	Cross-connector (terminal), Plugged, red, 32 A, Number of poles: 3,
GTIN (EAN)	4050118476231	Pitch in mm (P): 6.10, Insulated: Yes, Width: 16 mm
Qty.	60 ST	
Type	ZQV 4N/30	Version
Order No.	2561580000	Cross-connector (terminal), Plugged, orange, 32 A, Number of poles:
GTIN (EAN)	4050118570113	30, Pitch in mm (P): 6.10, Insulated: Yes, Width: 181.7 mm
Qty.	5 ST	
Type	ZQV 4N/30 BL	Version
Order No.	2561610000	Cross-connector (terminal), Plugged, blue, 32 A, Number of poles: 30,
GTIN (EAN)	4050118569971	Pitch in mm (P): 6.10, Insulated: Yes, Width: 181.7 mm
Qty.	5 ST	
Type	ZQV 4N/30 RD	Version
Order No.	2561600000	Cross-connector (terminal), Plugged, red, 32 A, Number of poles: 30,
GTIN (EAN)	4050118569964	Pitch in mm (P): 6.10, Insulated: Yes, Width: 181.7 mm
Qty.	5 ST	
Type	ZQV 4N/32	Version
Order No.	2561670000	Cross-connector (terminal), Plugged, orange, 32 A, Number of poles:
GTIN (EAN)	4050118570175	32, Pitch in mm (P): 6.10, Insulated: Yes, Width: 193.9 mm
Qty.	5 ST	
Type	ZQV 4N/4	Version
Order No.	1527970000	Cross-connector (terminal), Plugged, orange, 32 A, Number of poles:
GTIN (EAN)	4050118332889	4, Pitch in mm (P): 6.10, Insulated: Yes, Width: 22.1 mm
Qty.	60 ST	
Type	ZQV 4N/4 BL	Version
Order No.	1528120000	Cross-connector (terminal), Plugged, blue, 32 A, Number of poles: 4,
GTIN (EAN)	4050118332872	Pitch in mm (P): 6.10, Insulated: Yes, Width: 22.1 mm
Qty.	60 ST	
Type	ZQV 4N/4 RD	Version
Order No.	2460800000	Cross-connector (terminal), Plugged, red, 32 A, Number of poles: 4,
GTIN (EAN)	4050118476224	Pitch in mm (P): 6.10, Insulated: Yes, Width: 22.1 mm
Qty.	60 ST	
Type	ZQV 4N/5	Version
Order No.	1527980000	Cross-connector (terminal), Plugged, orange, 32 A, Number of poles:
GTIN (EAN)	4050118332759	5, Pitch in mm (P): 6.10, Insulated: Yes, Width: 28.2 mm
Qty.	60 ST	
Type	ZQV 4N/5 BL	Version
Order No.	1528140000	Cross-connector (terminal), Plugged, blue, 32 A, Number of poles: 5,
GTIN (EAN)	4050118333015	Pitch in mm (P): 6.10, Insulated: Yes, Width: 28.2 mm
Qty.	60 ST	
Type	ZQV 4N/5 RD	Version
Order No.	2460790000	Cross-connector (terminal), Plugged, red, 32 A, Number of poles: 5,
GTIN (EAN)	4050118476217	Pitch in mm (P): 6.10, Insulated: Yes, Width: 28.2 mm
Qty.	60 ST	
Type	ZQV 4N/50	Version
Order No.	1528130000	Cross-connector (terminal), Plugged, orange, 32 A, Number of poles:
GTIN (EAN)	4050118332902	50, Pitch in mm (P): 6.10, Insulated: Yes, Width: 303.7 mm
Qty.	5 ST	
Type	ZQV 4N/50 BL	Version
Order No.	1528240000	Cross-connector (terminal), Plugged, blue, 32 A, Number of poles: 50,
GTIN (EAN)	4050118333121	Pitch in mm (P): 6.10, Insulated: Yes, Width: 303.7 mm
Qty.	5 ST	

WFS 4 100-250V

Weidmüller Interface GmbH & Co. KG

Klingenbergstraße 26
D-32758 Detmold
Germany

www.weidmueller.com

Accessories

Type	ZQV 4N/50 RD	Version
Order No.	2460730000	Cross-connector (terminal), Plugged, red, 32 A, Number of poles: 50,
GTIN (EAN)	4050118476156	Pitch in mm (P): 6.10, Insulated: Yes, Width: 303.7 mm
Qty.	5 ST	
Type	ZQV 4N/6	Version
Order No.	1527990000	Cross-connector (terminal), Plugged, orange, 32 A, Number of poles:
GTIN (EAN)	4050118332919	6, Pitch in mm (P): 6.10, Insulated: Yes, Width: 34.3 mm
Qty.	20 ST	
Type	ZQV 4N/6 BL	Version
Order No.	1528170000	Cross-connector (terminal), Plugged, blue, 32 A, Number of poles: 6,
GTIN (EAN)	4050118332926	Pitch in mm (P): 6.10, Insulated: Yes, Width: 34.3 mm
Qty.	20 ST	
Type	ZQV 4N/6 RD	Version
Order No.	2460780000	Cross-connector (terminal), Plugged, red, 32 A, Number of poles: 6,
GTIN (EAN)	4050118476200	Pitch in mm (P): 6.10, Insulated: Yes, Width: 34.3 mm
Qty.	20 ST	
Type	ZQV 4N/7	Version
Order No.	1528020000	Cross-connector (terminal), Plugged, orange, 32 A, Number of poles:
GTIN (EAN)	4050118332780	7, Pitch in mm (P): 6.10, Insulated: Yes, Width: 40.4 mm
Qty.	20 ST	
Type	ZQV 4N/7 BL	Version
Order No.	1528180000	Cross-connector (terminal), Plugged, blue, 32 A, Number of poles: 7,
GTIN (EAN)	4050118333114	Pitch in mm (P): 6.10, Insulated: Yes, Width: 40.4 mm
Qty.	20 ST	
Type	ZQV 4N/7 RD	Version
Order No.	2460770000	Cross-connector (terminal), Plugged, red, 32 A, Number of poles: 7,
GTIN (EAN)	4050118476194	Pitch in mm (P): 6.10, Insulated: Yes, Width: 40.4 mm
Qty.	20 ST	
Type	ZQV 4N/8	Version
Order No.	1528030000	Cross-connector (terminal), Plugged, orange, 32 A, Number of poles:
GTIN (EAN)	4050118332841	8, Pitch in mm (P): 6.10, Insulated: Yes, Width: 46.5 mm
Qty.	20 ST	
Type	ZQV 4N/8 BL	Version
Order No.	1528190000	Cross-connector (terminal), Plugged, blue, 32 A, Number of poles: 8,
GTIN (EAN)	4050118332858	Pitch in mm (P): 6.10, Insulated: Yes, Width: 46.5 mm
Qty.	20 ST	
Type	ZQV 4N/8 RD	Version
Order No.	2460760000	Cross-connector (terminal), Plugged, red, 32 A, Number of poles: 8,
GTIN (EAN)	4050118476187	Pitch in mm (P): 6.10, Insulated: Yes, Width: 46.5 mm
Qty.	20 ST	
Type	ZQV 4N/9	Version
Order No.	1528070000	Cross-connector (terminal), Plugged, orange, 32 A, Number of poles:
GTIN (EAN)	4050118332797	9, Pitch in mm (P): 6.10, Insulated: Yes, Width: 52.6 mm
Qty.	20 ST	
Type	ZQV 4N/9 BL	Version
Order No.	1528220000	Cross-connector (terminal), Plugged, blue, 32 A, Number of poles: 9,
GTIN (EAN)	4050118333107	Pitch in mm (P): 6.10, Insulated: Yes, Width: 52.6 mm
Qty.	20 ST	
Type	ZQV 4N/9 RD	Version
Order No.	2460750000	Cross-connector (terminal), Plugged, red, 32 A, Number of poles: 9,
GTIN (EAN)	4050118476170	Pitch in mm (P): 6.10, Insulated: Yes, Width: 52.6 mm
Qty.	20 ST	

WFS 4 100-250V

Weidmüller Interface GmbH & Co. KG

Klingenbergstraße 26

D-32758 Detmold

Germany

www.weidmueller.com

Accessories

End bracket

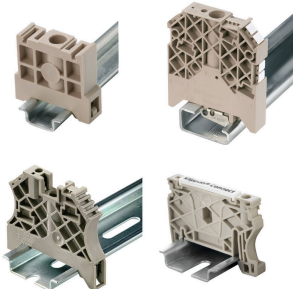

Weidmüller's range of products includes end brackets that guarantee a permanent, reliable mounting on the terminal rail and prevent sliding. Versions with and without screws are available. The end brackets include marking options, also for group markers, and also a test plug holder.

General ordering data

Type	WEW 35/2	Version
Order No.	1061200000	End bracket, dark beige, TS 35, HB, Wemid, Width: 8 mm, 100 °C
GTIN (EAN)	4008190030230	
Qty.	50 ST	
Type	WEW 35/2 GR	Version
Order No.	1859200000	End bracket, grey, TS 35, V-2, Wemid, Width: 8 mm, 100 °C
GTIN (EAN)	4032248411658	
Qty.	50 ST	
Type	WEW 35/2 SW	Version
Order No.	1061210000	End bracket, black, TS 35, V-2, Wemid, Width: 8 mm, 100 °C
GTIN (EAN)	4032248136278	
Qty.	50 ST	
Type	WEW 35/2 VO GF SW	Version
Order No.	1479000000	End bracket, black, TS 35, V-0, Wemid, Width: 8 mm, 130 °C
GTIN (EAN)	4050118286779	
Qty.	50 ST	

WS 8/6



WS/ DEK

MultiMark terminal markers use an innovative composite material made from two components. The hard base contour of the marker snaps securely into the connector. The elastic surface finish makes the marker easy to mount. This specially punched material enables the strips to be stretched to accommodate the slight variations in spacing that tend to add up, especially with long terminal blocks. Another advantage: the excellent printability of the surface material guarantees durable and wear-resistant labelling. A print resolution of 300 dpi also produces a very legible script.

Your benefits with MultiMark

- Firm hold and durable printing
- Continuous strips save installation time
- Easy mounting thanks to an innovative composite material
- Large label field for optimal legibility
- High flexibility thanks to manufacturer independence

WFS 4 100-250V

Weidmüller Interface GmbH & Co. KG

Klingenbergstraße 26

D-32758 Detmold

Germany

www.weidmueller.com

Accessories

General ordering data

Type	WS 8/6 MM WS	Version
Order No.	2007160000	WS, Terminal marker, 8 x 6 mm, Weidmueller, white
GTIN (EAN)	4050118391879	
Qty.	600 ST	

WS 12/6



WS/ DEK

MultiMark terminal markers use an innovative composite material made from two components. The hard base contour of the marker snaps securely into the connector. The elastic surface finish makes the marker easy to mount. This specially punched material enables the strips to be stretched to accommodate the slight variations in spacing that tend to add up, especially with long terminal blocks. Another advantage: the excellent printability of the surface material guarantees durable and wear-resistant labelling. A print resolution of 300 dpi also produces a very legible script.

Your benefits with MultiMark

- Firm hold and durable printing
- Continuous strips save installation time
- Easy mounting thanks to an innovative composite material
- Large label field for optimal legibility
- High flexibility thanks to manufacturer independence

General ordering data

Type	WS 12/6 MM WS	Version
Order No.	2007200000	WS, Terminal marker, 12 x 6 mm, Weidmueller, white
GTIN (EAN)	4050118391886	
Qty.	600 ST	

DEK 5/6



WS/ DEK

MultiMark terminal markers use an innovative composite material made from two components. The hard base contour of the marker snaps securely into the connector. The elastic surface finish makes the marker easy to mount. This specially punched material enables the strips to be stretched to accommodate the slight variations in spacing that tend to add up, especially with long terminal blocks. Another advantage: the excellent printability of the surface material guarantees durable and wear-resistant labelling. A print resolution of 300 dpi also produces a very legible script.

Your benefits with MultiMark

- Firm hold and durable printing
- Continuous strips save installation time
- Easy mounting thanks to an innovative composite material
- Large label field for optimal legibility
- High flexibility thanks to manufacturer independence

WFS 4 100-250V

Weidmüller Interface GmbH & Co. KG

Klingenbergstraße 26

D-32758 Detmold

Germany

www.weidmueller.com

Accessories

General ordering data

Type	DEK 5/6 MM WS	Version
Order No.	2007120000	Dekafix, Terminal marker, 5 x 6 mm, Weidmueller, white
GTIN (EAN)	4050118392104	
Qty.	600 ST	

Blank



The Dekafix (DEK) marker is the universal marker for all conductor and plug-in connectors as well as for electronic sub-assemblies. The system is ideal for short number sequences and covers a wide range of ready-printed markers.

Strips for fast installation in only one work step. The printing is easy to read, rich in contrast and available in various widths.

- Large range of ready-to-use markers
 - Strips for fast installation
 - Terminal markers, suitable for all Weidmüller cable connectors
 - Available as blank MultiCard or with standard printing
- For custom printing: Please send us a file of our labeling software M-Print PRO or M-Print PRO Online (without installation) for your labeling specifications.

General ordering data

Type	DEK 5/6 MC NE BL	Version
Order No.	1238290000	Dekafix, Terminal marker, 5 x 6 mm, Pitch in mm (P): 6.00
GTIN (EAN)	4050118267327	Weidmueller, blue
Qty.	1000 ST	
Type	DEK 5/6 MC NE BR	Version
Order No.	1454900000	Dekafix, Terminal marker, 5 x 6 mm, Pitch in mm (P): 6.00
GTIN (EAN)	4050118323313	Weidmueller, brown
Qty.	1000 ST	
Type	DEK 5/6 MC NE GE	Version
Order No.	1238280000	Dekafix, Terminal marker, 5 x 6 mm, Pitch in mm (P): 6.00
GTIN (EAN)	4050118038750	Weidmueller, yellow
Qty.	1000 ST	
Type	DEK 5/6 MC NE GN	Version
Order No.	1238310000	Dekafix, Terminal marker, 5 x 6 mm, Pitch in mm (P): 6.00
GTIN (EAN)	4050118271812	Weidmueller, green
Qty.	1000 ST	
Type	DEK 5/6 MC NE GR	Version
Order No.	1238330000	Dekafix, Terminal marker, 5 x 6 mm, Pitch in mm (P): 6.00
GTIN (EAN)	4050118323306	Weidmueller, grey
Qty.	1000 ST	
Type	DEK 5/6 MC NE OR	Version
Order No.	1912090000	Dekafix, Terminal marker, 5 x 6 mm, Pitch in mm (P): 6.00
GTIN (EAN)	4032248540525	Weidmueller, orange
Qty.	1000 ST	
Type	DEK 5/6 MC NE WS	Version
Order No.	1609820000	Dekafix, Terminal marker, 5 x 6 mm, Pitch in mm (P): 6.00
GTIN (EAN)	4008190203436	Weidmueller, white
Qty.	1000 ST	

Custom printing



The Dekafix (DEK) marker is the universal marker for all conductor and plug-in connectors as well as for electronic sub-assemblies. The system is ideal for short number sequences and covers a wide range of ready-printed markers.

Strips for fast installation in only one work step. The printing is easy to read, rich in contrast and available in various widths.

- Large range of ready-to-use markers
 - Strips for fast installation
 - Terminal markers, suitable for all Weidmüller cable connectors
 - Available as blank MultiCard or with standard printing
- For custom printing: Please send us a file of our labeling software M-Print PRO or M-Print PRO Online (without installation) for your labeling specifications.

General ordering data

Type	DEK 5/6 MC SDR	Version	
Order No.	1609830000		Dekafix, Terminal marker, 5 x 6 mm, Pitch in mm (P): 6.00
GTIN (EAN)	4008190456603		Weidmueller, To customer specification
Qty.	200 ST		

Plus



The Dekafix (DEK) marker is the universal marker for all conductor and plug-in connectors as well as for electronic sub-assemblies. The system is ideal for short number sequences and covers a wide range of ready-printed markers.

Strips for fast installation in only one work step. The printing is easy to read, rich in contrast and available in various widths.

- Large range of ready-to-use markers
 - Strips for fast installation
 - Terminal markers, suitable for all Weidmüller cable connectors
 - Available as blank MultiCard or with standard printing
- For custom printing: Please send us a file of our labeling software M-Print PRO or M-Print PRO Online (without installation) for your labeling specifications.

General ordering data

Type	DEK 5/6 PLUS MC NE WS	Version	
Order No.	1011320000		Dekafix, Terminal marker, 5 x 6 mm, Pitch in mm (P): 6.00
GTIN (EAN)	4032248717644		Weidmueller, white
Qty.	1000 ST		

WFS 4 100-250V

Weidmüller Interface GmbH & Co. KG

Klingenbergstraße 26

D-32758 Detmold

Germany

Accessories

www.weidmueller.com

Custom printing



The Dekafix (DEK) marker is the universal marker for all conductor and plug-in connectors as well as for electronic sub-assemblies. The system is ideal for short number sequences and covers a wide range of ready-printed markers.

Strips for fast installation in only one work step. The printing is easy to read, rich in contrast and available in various widths.

- Large range of ready-to-use markers
 - Strips for fast installation
 - Terminal markers, suitable for all Weidmüller cable connectors
 - Available as blank MultiCard or with standard printing
- For custom printing: Please send us a file of our labeling software M-Print PRO or M-Print PRO Online (without installation) for your labeling specifications.

General ordering data

Type	DEK 5/6 PLUS MC SDR	Version
Order No.	1038650000	Dekafix, Terminal marker, 5 x 6 mm, Pitch in mm (P): 6.00
GTIN (EAN)	4032248767908	Weidmueller, To customer specification
Qty.	200 ST	

Blank

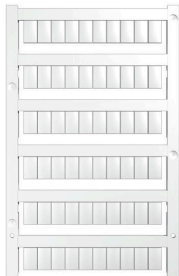

WS markers are the perfect match for the W-series connectors. Thanks to their system compatibility, the WS tags can also be used with the I-series and the Z-series. The large marking surfaces do not only permit long character strings but also multi-line text. WS markers are ideal for labels with long, customised character strings. Thanks to the proven MultiCard format, printing with PrintJet CONNECT oder/or Plotter is possible.

- Can be fitted in strips or individually
- Markers in proven MultiCard format

For custom printing: Please send us a file of our labeling software M-Print PRO or M-Print PRO Online (without installation) for your labeling specifications.

General ordering data

Type	WS 10/6 M MC NE WS	Version
Order No.	1818400000	WS, Terminal marker, 10 x 6 mm, Pitch in mm (P): 6.00 Weidmueller,
GTIN (EAN)	4032248310876	Allen-Bradley, white
Qty.	600 ST	
Type	WS 10/6 M PLUS MC NE WS	Version
Order No.	2003780000	WS, Terminal marker, 10 x 6 mm, Pitch in mm (P): 6.00 Weidmueller,
GTIN (EAN)	4050118424461	Allen-Bradley, white
Qty.	600 ST	

WFS 4 100-250V

Weidmüller Interface GmbH & Co. KG

Klingenbergstraße 26

D-32758 Detmold

Germany

www.weidmueller.com

Accessories

Custom printing



WS markers are the perfect match for the W-series connectors. Thanks to their system compatibility, the WS tags can also be used with the I-series and the Z-series. The large marking surfaces do not only permit long character strings but also multi-line text. WS markers are ideal for labels with long, customised character strings. Thanks to the proven MultiCard format, printing with PrintJet CONNECT oder/or Plotter is possible.

- Can be fitted in strips or individually
- Markers in proven MultiCard format

For custom printing: Please send us a file of our labeling software M-Print PRO or M-Print PRO Online (without installation) for your labeling specifications.

General ordering data

Type	WS 10/6 M PLUS MC SDR	Version
Order No.	2007780000	WS, Terminal marker, 10 x 6 mm, Pitch in mm (P): 6.00 Weidmueller,
GTIN (EAN)	4050118393187	Allen-Bradley, To customer specification
Qty.	120 ST	

Blank



WS markers are the perfect match for the W-series connectors. Thanks to their system compatibility, the WS tags can also be used with the I-series and the Z-series. The large marking surfaces do not only permit long character strings but also multi-line text. WS markers are ideal for labels with long, customised character strings. Thanks to the proven MultiCard format, printing with PrintJet CONNECT oder/or Plotter is possible.

- Can be fitted in strips or individually
- Markers in proven MultiCard format

For custom printing: Please send us a file of our labeling software M-Print PRO or M-Print PRO Online (without installation) for your labeling specifications.

General ordering data

Type	WS 10/6 MC M NE BL	Version
Order No.	1069080000	WS, Terminal marker, 10 x 6 mm, Pitch in mm (P): 6.00 Weidmueller,
GTIN (EAN)	4032248824618	Allen-Bradley, blue
Qty.	600 ST	
Type	WS 10/6 MC M NE GE	Version
Order No.	1917430000	WS, Terminal marker, 10 x 6 mm, Pitch in mm (P): 6.00 Weidmueller,
GTIN (EAN)	4032248551637	Allen-Bradley, yellow
Qty.	600 ST	
Type	WS 10/6 MC M NE GN	Version
Order No.	1917420000	WS, Terminal marker, 10 x 6 mm, Pitch in mm (P): 6.00 Weidmueller,
GTIN (EAN)	4032248551620	Allen-Bradley, green
Qty.	600 ST	

WFS 4 100-250V

Weidmüller Interface GmbH & Co. KG

Klingenbergstraße 26
D-32758 Detmold
Germany

www.weidmueller.com

Accessories

Type	WS 10/6 MC M NE RT	Version
Order No.	1917440000	WS, Terminal marker, 10 x 6 mm, Pitch in mm (P): 6.00 Weidmueller,
GTIN (EAN)	4032248551644	Allen-Bradley, red
Qty.	600 ST	

Custom printing



WS markers are the perfect match for the W-series connectors. Thanks to their system compatibility, the WS tags can also be used with the I-series and the Z-series. The large marking surfaces do not only permit long character strings but also multi-line text. WS markers are ideal for labels with long, customised character strings. Thanks to the proven MultiCard format, printing with PrintJet CONNECT oder/or Plotter is possible.

- Can be fitted in strips or individually
- Markers in proven MultiCard format

For custom printing: Please send us a file of our labeling software M-Print PRO or M-Print PRO Online (without installation) for your labeling specifications.

General ordering data

Type	WS 10/6 MC M SDR	Version
Order No.	1818410000	WS, Terminal marker, 10 x 6 mm, Pitch in mm (P): 6.00 Weidmueller,
GTIN (EAN)	4032248310883	Allen-Bradley, To customer specification
Qty.	120 ST	

Blank



WS markers are the perfect match for the W-series connectors. Thanks to their system compatibility, the WS tags can also be used with the I-series and the Z-series. The large marking surfaces do not only permit long character strings but also multi-line text. WS markers are ideal for labels with long, customised character strings. Thanks to the proven MultiCard format, printing with PrintJet CONNECT oder/or Plotter is possible.

- Can be fitted in strips or individually
- Markers in proven MultiCard format

For custom printing: Please send us a file of our labeling software M-Print PRO or M-Print PRO Online (without installation) for your labeling specifications.

General ordering data

Type	WS 10/6 MC NE WS	Version
Order No.	1828450000	WS, Terminal marker, 10 x 6 mm, Pitch in mm (P): 6.00 Weidmueller,
GTIN (EAN)	4032248350513	Allen-Bradley, white
Qty.	600 ST	

WFS 4 100-250V

Weidmüller Interface GmbH & Co. KG

Klingenbergstraße 26

D-32758 Detmold

Germany

Accessories

www.weidmueller.com

Custom printing



WS markers are the perfect match for the W-series connectors. Thanks to their system compatibility, the WS tags can also be used with the I-series and the Z-series. The large marking surfaces do not only permit long character strings but also multi-line text. WS markers are ideal for labels with long, customised character strings. Thanks to the proven MultiCard format, printing with PrintJet CONNECT oder/or Plotter is possible.

- Can be fitted in strips or individually
- Markers in proven MultiCard format

For custom printing: Please send us a file of our labeling software M-Print PRO or M-Print PRO Online (without installation) for your labeling specifications.

General ordering data

Type	WS 10/6 MC SDR	Version
Order No.	1828460000	WS, Terminal marker, 10 x 6 mm, Pitch in mm (P): 6.00 Weidmueller,
GTIN (EAN)	4032248367399	Allen-Bradley, To customer specification
Qty.	120 ST	

Blank



WS markers are the perfect match for the W-series connectors. Thanks to their system compatibility, the WS tags can also be used with the I-series and the Z-series. The large marking surfaces do not only permit long character strings but also multi-line text. WS markers are ideal for labels with long, customised character strings. Thanks to the proven MultiCard format, printing with PrintJet CONNECT oder/or Plotter is possible.

- Can be fitted in strips or individually
- Markers in proven MultiCard format

For custom printing: Please send us a file of our labeling software M-Print PRO or M-Print PRO Online (without installation) for your labeling specifications.

General ordering data

Type	WS 10/6 PLUS MC NE WS	Version
Order No.	1046390000	WS, Terminal marker, 10 x 6 mm, Pitch in mm (P): 6.00 Weidmueller,
GTIN (EAN)	4032248782109	Allen-Bradley, white
Qty.	600 ST	

WFS 4 100-250V

Weidmüller Interface GmbH & Co. KG

Klingenbergstraße 26

D-32758 Detmold

Germany

www.weidmueller.com

Accessories

Custom printing



WS markers are the perfect match for the W-series connectors. Thanks to their system compatibility, the WS tags can also be used with the I-series and the Z-series. The large marking surfaces do not only permit long character strings but also multi-line text. WS markers are ideal for labels with long, customised character strings. Thanks to the proven MultiCard format, printing with PrintJet CONNECT oder/or Plotter is possible.

- Can be fitted in strips or individually
- Markers in proven MultiCard format

For custom printing: Please send us a file of our labeling software M-Print PRO or M-Print PRO Online (without installation) for your labeling specifications.

General ordering data

Type	WS 10/6 PLUS MC SDR	Version
Order No.	1046330000	WS, Terminal marker, 10 x 6 mm, Pitch in mm (P): 6.00 Weidmueller,
GTIN (EAN)	4032248782031	Allen-Bradley, To customer specification
Qty.	120 ST	

Blank



WS markers are the perfect match for the W-series connectors. Thanks to their system compatibility, the WS tags can also be used with the I-series and the Z-series. The large marking surfaces do not only permit long character strings but also multi-line text. WS markers are ideal for labels with long, customised character strings. Thanks to the proven MultiCard format, printing with PrintJet CONNECT oder/or Plotter is possible.

- Can be fitted in strips or individually
- Markers in proven MultiCard format

For custom printing: Please send us a file of our labeling software M-Print PRO or M-Print PRO Online (without installation) for your labeling specifications.

General ordering data

Type	WS 12/6 MC NE BL	Version
Order No.	1773551693	WS, Terminal marker, 12 x 6 mm, Pitch in mm (P): 6.00 Weidmueller,
GTIN (EAN)	4032248143269	Allen-Bradley, blue
Qty.	600 ST	
Type	WS 12/6 MC NE BR	Version
Order No.	1773551692	WS, Terminal marker, 12 x 6 mm, Pitch in mm (P): 6.00 Weidmueller,
GTIN (EAN)	4032248143252	Allen-Bradley, brown
Qty.	600 ST	
Type	WS 12/6 MC NE GE	Version
Order No.	1773551687	WS, Terminal marker, 12 x 6 mm, Pitch in mm (P): 6.00 Weidmueller,
GTIN (EAN)	4032248141937	Allen-Bradley, yellow
Qty.	600 ST	

WFS 4 100-250V

Weidmüller Interface GmbH & Co. KG
 Klingenbergstraße 26
 D-32758 Detmold
 Germany

www.weidmueller.com

Accessories

Type	WS 12/6 MC NE OR	Version
Order No.	1773551690	WS, Terminal marker, 12 x 6 mm, Pitch in mm (P): 6.00 Weidmueller,
GTIN (EAN)	4032248 143245	Allen-Bradley, orange
Qty.	600 ST	
Type	WS 12/6 MC NE RT	Version
Order No.	1773551686	WS, Terminal marker, 12 x 6 mm, Pitch in mm (P): 6.00 Weidmueller,
GTIN (EAN)	4032248 141920	Allen-Bradley, red
Qty.	600 ST	
Type	WS 12/6 MC NE VI	Version
Order No.	1773551689	WS, Terminal marker, 12 x 6 mm, Pitch in mm (P): 6.00 Weidmueller,
GTIN (EAN)	4032248 143238	Allen-Bradley, violet
Qty.	600 ST	
Type	WS 12/6 MC NE WS	Version
Order No.	1609900000	WS, Terminal marker, 12 x 6 mm, Pitch in mm (P): 6.00 Weidmueller,
GTIN (EAN)	4008190203467	Allen-Bradley, white
Qty.	600 ST	

Custom printing



WS markers are the perfect match for the W-series connectors. Thanks to their system compatibility, the WS tags can also be used with the I-series and the Z-series. The large marking surfaces do not only permit long character strings but also multi-line text. WS markers are ideal for labels with long, customised character strings. Thanks to the proven MultiCard format, printing with PrintJet CONNECT oder/or Plotter is possible.

- Can be fitted in strips or individually
- Markers in proven MultiCard format

For custom printing: Please send us a file of our labeling software M-Print PRO or M-Print PRO Online (without installation) for your labeling specifications.

General ordering data

Type	WS 12/6 MC SDR	Version
Order No.	1609910000	WS, Terminal marker, 12 x 6 mm, Pitch in mm (P): 6.00 Weidmueller,
GTIN (EAN)	4008190456658	Allen-Bradley, To customer specification
Qty.	120 ST	

WFS 4 100-250V

Weidmüller Interface GmbH & Co. KG
 Klingenbergstraße 26
 D-32758 Detmold
 Germany

www.weidmueller.com

Accessories

Blank



WS markers are the perfect match for the W-series connectors. Thanks to their system compatibility, the WS tags can also be used with the I-series and the Z-series. The large marking surfaces do not only permit long character strings but also multi-line text. WS markers are ideal for labels with long, customised character strings. Thanks to the proven MultiCard format, printing with PrintJet CONNECT oder/or Plotter is possible.

- Can be fitted in strips or individually
- Markers in proven MultiCard format

For custom printing: Please send us a file of our labeling software M-Print PRO or M-Print PRO Online (without installation) for your labeling specifications.

General ordering data

Type	WS 12/6 PLUS MC NE WS	Version
Order No.	1927530000	WS, Terminal marker, 12 x 6 mm, Pitch in mm (P): 6.00 Weidmueller,
GTIN (EAN)	4032248574209	Allen-Bradley, white
Qty.	600 ST	

Custom printing

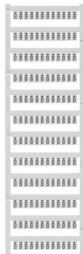

WS markers are the perfect match for the W-series connectors. Thanks to their system compatibility, the WS tags can also be used with the I-series and the Z-series. The large marking surfaces do not only permit long character strings but also multi-line text. WS markers are ideal for labels with long, customised character strings. Thanks to the proven MultiCard format, printing with PrintJet CONNECT oder/or Plotter is possible.

- Can be fitted in strips or individually
- Markers in proven MultiCard format

For custom printing: Please send us a file of our labeling software M-Print PRO or M-Print PRO Online (without installation) for your labeling specifications.

General ordering data

Type	WS 12/6 PLUS MC SDR	Version
Order No.	1927540000	WS, Terminal marker, 12 x 6 mm, Pitch in mm (P): 6.00 Weidmueller,
GTIN (EAN)	4032248574711	Allen-Bradley, To customer specification
Qty.	120 ST	

WFS 4 100-250V

Weidmüller Interface GmbH & Co. KG
 Klingenbergstraße 26
 D-32758 Detmold
 Germany

www.weidmueller.com

Accessories

Blank

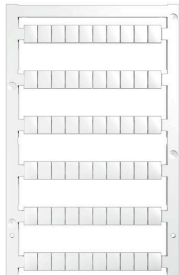

WS markers are the perfect match for the W-series connectors. Thanks to their system compatibility, the WS tags can also be used with the I-series and the Z-series. The large marking surfaces do not only permit long character strings but also multi-line text. WS markers are ideal for labels with long, customised character strings. Thanks to the proven MultiCard format, printing with PrintJet CONNECT oder/or Plotter is possible.

- Can be fitted in strips or individually
- Markers in proven MultiCard format

For custom printing: Please send us a file of our labeling software M-Print PRO or M-Print PRO Online (without installation) for your labeling specifications.

General ordering data

Type	WS 8/6 PLUS MC NE WS	Version
Order No.	1951880000	WS, Terminal marker, 8 x 6 mm, Pitch in mm (P): 6.00 Weidmueller,
GTIN (EAN)	4032248632114	white
Qty.	600 ST	

Custom printing



WS markers are the perfect match for the W-series connectors. Thanks to their system compatibility, the WS tags can also be used with the I-series and the Z-series. The large marking surfaces do not only permit long character strings but also multi-line text. WS markers are ideal for labels with long, customised character strings. Thanks to the proven MultiCard format, printing with PrintJet CONNECT oder/or Plotter is possible.

- Can be fitted in strips or individually
- Markers in proven MultiCard format

For custom printing: Please send us a file of our labeling software M-Print PRO or M-Print PRO Online (without installation) for your labeling specifications.

General ordering data

Type	WS 8/6 PLUS MC SDR	Version
Order No.	1038820000	WS, Terminal marker, 8 x 6 mm, Pitch in mm (P): 6.00 Weidmueller,
GTIN (EAN)	4032248768073	To customer specification
Qty.	120 ST	

WFS 4 100-250V

Weidmüller Interface GmbH & Co. KG

Klingenbergstraße 26

D-32758 Detmold

Germany

www.weidmueller.com

Accessories

Marker holder



The marker holder offer the possibility of additional mounting of standard markers with a pitch of 5 or 5.1 mm. The angled holders can be optionally snapped together and could be mounted in all standard marking channels of the Klippon® Connect modular terminal blocks. Fitting marker types could be found under the respective accessories of the designation marking holder.

General ordering data

Type	BZT 1 WS 10/5	Version	
Order No.	1805490000	Accessories, Marker holder	
GTIN (EAN)	4032248270231		
Qty.	100 ST		
Type	BZT 1 ZA WS 10/5	Version	
Order No.	1805520000	Accessories, Marker holder	
GTIN (EAN)	4032248270248		
Qty.	100 ST		

End bracket

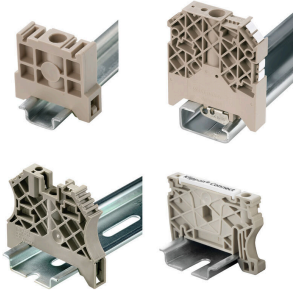

Weidmüller's range of products includes end brackets that guarantee a permanent, reliable mounting on the terminal rail and prevent sliding. Versions with and without screws are available. The end brackets include marking options, also for group markers, and also a test plug holder.

General ordering data

Type	ZST 1	Version	
Order No.	1269070000	Accessories, Accessories holder	
GTIN (EAN)	4050118094091		
Qty.	25 ST		

Cross-connections

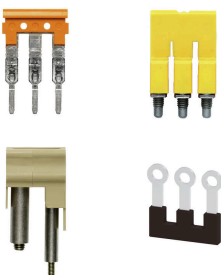

The distribution or multiplication of a potential to adjoining terminal blocks is realized via a cross-connection. Additional wiring effort can be easily avoided. Even if the poles are broken out, contact reliability in the terminal blocks is still ensured. Our portfolio offers pluggable and screwable cross-connection systems for modular terminal blocks.

WFS 4 100-250V

Weidmüller Interface GmbH & Co. KG
Klingenbergstraße 26
D-32758 Detmold
Germany

www.weidmueller.com

Accessories

General ordering data

Type	VH 20/5/3.4	Version	
Order No.	0446100000	Dummy fuse	
GTIN (EAN)	4008190519742		
Qty.	10 ST		