

WFS 4 100-250V DB**Weidmüller Interface GmbH & Co. KG**

Klingenbergstraße 26

D-32758 Detmold

Germany

www.weidmueller.com

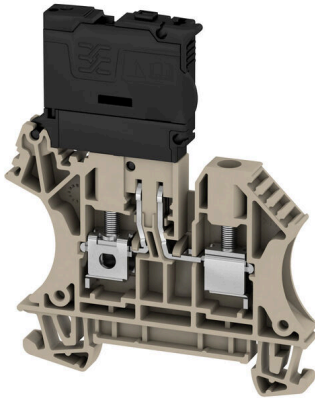
Product image

Fuse terminal blocks and component terminal blocks allow protective and functional elements to be integrated directly into the terminal strip. Fuse terminal blocks include built-in fuse holders to reliably protect electrical circuits against overload –ideal for control and distribution systems. Component terminal blocks make it possible to incorporate electronic components such as diodes, resistors, or LEDs directly into the wiring. This enables space-saving and clearly arranged implementation of switching functions and signal separation. Both types of terminal blocks ensure higher safety, easy maintenance, and a compact, function-oriented installation.

General ordering data

| | |
|------------|---|
| Version | Fuse terminal, Screw connection, dark beige, 4 mm ² , 6.3 A, 250 V, Number of connections: 2, Number of levels: 1, TS 35 |
| Order No. | 2561950000 |
| Type | WFS 4 100-250V DB |
| GTIN (EAN) | 4050118570427 |
| Qty. | 50 items |

WFS 4 100-250V DB

Weidmüller Interface GmbH & Co. KG

Klingenbergstraße 26

D-32758 Detmold

Germany

www.weidmueller.com

Technical data

Approvals

Approvals

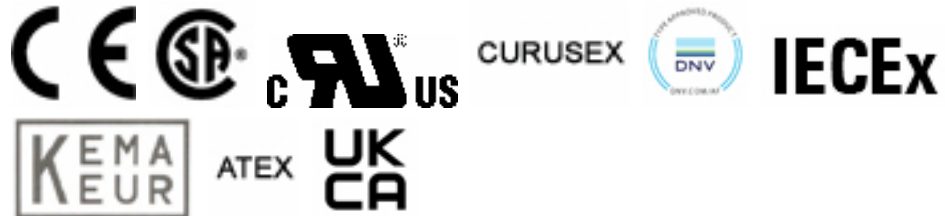

| | |
|---------------------------|----------------------------|
| ROHS | Conform |
| UL File Number Search | UL Website |
| Certificate No. (cURus) | E60693 |
| Certificate No. (cURusEX) | E184763 |

Dimensions and weights

| | | | |
|--------------------------|-------------|----------------|-------------|
| Depth | 75 mm | Depth (inches) | 2.9527 inch |
| Depth including DIN rail | 75.5 mm | Height | 62.5 mm |
| Height (inches) | 2.4606 inch | Width | 6.1 mm |
| Width (inches) | 0.2402 inch | Net weight | 17.69 g |

Temperatures

| | | | |
|----------------------------------|----------------|----------------------------------|---------------|
| Storage temperature | -25 °C...55 °C | Ambient temperature | -5 °C...40 °C |
| Continuous operating temp., min. | -60 °C | Continuous operating temp., max. | 130 °C |

Environmental Product Compliance

| | |
|------------------------|-----------------------------|
| RoHS Compliance Status | Compliant without exemption |
| REACH SVHC | No SVHC above 0.1 wt% |

Material data

| | | | |
|---------------------------|-------|--------|------------|
| Basic material | Wemid | Colour | dark beige |
| UL 94 flammability rating | V-0 | | |

Rating data IECEx/ATEX

| | | | |
|--------------------------------|-------------------|---------------------------------|-------------------|
| Certificate No. (ATEX) | TÜV20ATEX8502U | Certificate No. (IECEx) | IECExTUR20.0014U |
| Wire cross section max. (ATEX) | 6 mm ² | Wire cross section max. (IECEx) | 6 mm ² |

System specifications

| | | | |
|-------------------------------------|---------------------------------|-------------------------------|-----|
| Version | Screw connection, Fuse isolator | End cover plate required | Yes |
| Number of potentials | 1 | Number of levels | 1 |
| Number of clamping points per level | 2 | Number of potentials per tier | 1 |
| Levels cross-connected internally | No | PE connection | No |
| Mounting rail | TS 35 | N-function | No |
| PE function | No | PEN function | No |

Additional technical data

| | | | |
|------------|-------|------------------|---------|
| Open sides | right | Type of mounting | Snap-on |
|------------|-------|------------------|---------|

WFS 4 100-250V DB

Weidmüller Interface GmbH & Co. KG

Klingenbergstraße 26
D-32758 Detmold
Germany

www.weidmueller.com

Technical data

CSA rating data

| | | | |
|-------------------------------|--------|-----------------------|----------------|
| Wire cross section max. (CSA) | 10 AWG | Certificate No. (CSA) | 200039-1057876 |
| Voltage size B (CSA) | 300 V | Current size B (CSA) | 10 A |
| Voltage size D (CSA) | 300 V | Current size D (CSA) | 10 A |
| Wire cross section min. (CSA) | 22 AWG | | |

Conductors for clamping (additional connection)

Connection type, additional connection Screw connection

Conductors for clamping (rated connection)

| | | |
|---|--|--------------------|
| Gauge to IEC 60947-1 | A4 | |
| Wire connection cross section AWG, max. | AWG 10 | |
| Connection direction | on side | |
| Tightening torque, max. | 0.6 Nm | |
| Tightening torque, min. | 0.5 Nm | |
| Stripping length | 13 mm | |
| Type of connection 2 | Screw connection | |
| Type of connection | Screw connection | |
| Number of connections | 2 | |
| Clamping range, max. | 6 mm ² | |
| Clamping range, min. | 0.22 mm ² | |
| Clamping screw | M 3 | |
| Blade size | 0.6 x 3.5 mm | |
| Wire connection cross section AWG, min. | AWG 26 | |
| Wire connection cross-section, finely stranded with wire-end ferrules DIN 46228/4, max. | 4 mm ² | |
| Wire connection cross-section, finely stranded with wire-end ferrules DIN 46228/4, min. | 0.22 mm ² | |
| Wire connection cross-section, finely stranded with wire-end ferrules DIN 46228/1, max. | 4 mm ² | |
| Wire connection cross-section, finely stranded with wire-end ferrules DIN 46228/1, min. | 0.22 mm ² | |
| Wire connection cross section, finely stranded, max. | 4 mm ² | |
| Wire connection cross section, finely stranded, min. | 0.22 mm ² | |
| Connection cross-section, stranded, max. | 6 mm ² | |
| Connection cross-section, stranded, min. | 0.22 mm ² | |
| Torque level with DMS electric screwdriver | 2 | |
| Wire connection cross-section, solid core, max. | 6 mm ² | |
| Wire connection cross-section, solid core, min. | 0.22 mm ² | |
| Connection cross-section, finely stranded, min. | 0.22 mm ² | |
| Clampable conductor | Connection specification | |
| | Cross-section for conductor connection | |
| | Screw connection | |
| | Type | solid, H05(07) V-U |
| min. | 0.5 mm ² | |
| max. | 6 mm ² | |

WFS 4 100-250V DB

Weidmüller Interface GmbH & Co. KG

Klingenbergstraße 26
D-32758 Detmold
Germany

www.weidmueller.com

Technical data

| | | | |
|--|-------------------|-----------------------|------------|
| wire end ferrule | nominal | 4 mm ² | |
| | | Stripping length | min. 13 mm |
| | Tightening torque | | max. 13 mm |
| | | nominal | 13 mm |
| Connection specification | | Screw connection | |
| Cross-section for conductor connection | Type | stranded, H07V-R | |
| | min. | 1.5 mm ² | |
| | max. | 6 mm ² | |
| | nominal | 4 mm ² | |
| wire end ferrule | Stripping length | min. 13 mm | |
| | | max. 13 mm | |
| | Tightening torque | nominal 13 mm | |
| | | min. 0.5 Nm | |
| max. 0.6 Nm | | | |
| Connection specification | | Screw connection | |
| Cross-section for conductor connection | Type | flexible, H05(07) V-K | |
| | min. | 0.5 mm ² | |
| | max. | 4 mm ² | |
| | nominal | 4 mm ² | |
| wire end ferrule | Stripping length | min. 13 mm | |
| | | max. 13 mm | |
| | Tightening torque | nominal 13 mm | |
| | | min. 0.5 Nm | |
| max. 0.6 Nm | | | |

Fuse terminals

| | | | |
|--------------------------------------|--------------|---|----------|
| Cartridge fuse | G-Si. 5 x 20 | Fuse holder (cartridge holder) | Pivoting |
| Type of voltage for indicator | AC/DC | Current | 6.3 A |
| Display | LED | Operating voltage, max. | 250 V |
| Power loss, 1-pole ; 2-pole ; 3-pole | | Permitted power loss for fuse with semiconductor protection | |
| Leakage current, max. | 0.5 mA | | |

General

| | | | |
|---|---------------|---|--------|
| Wire connection cross section AWG, max. | AWG 10 | Wire connection cross section AWG, min. | AWG 26 |
| Standards | IEC 60947-7-3 | Mounting rail | TS 35 |

Rating data

| | | | |
|-------------------------------------|-------------------|--|--------|
| Rated cross-section | 4 mm ² | Rated voltage | 250 V |
| Rated voltage to adjoining terminal | 400 V | Rated DC voltage | 250 V |
| Nominal current | 6.3 A | Current at maximum wires | 6.3 A |
| Standards | IEC 60947-7-3 | Volume resistance according to IEC 60947-7-x | 1 mΩ |
| Rated impulse withstand voltage | 6 kV | Power loss in accordance with IEC 60947-7-x | 1.02 W |
| Pollution severity | 3 | | |

UL rating data

| | | | |
|--|--------|-------------------------|--------|
| Conductor size Factory wiring max. (cURus) | 10 AWG | Voltage size B (cURus) | 300 V |
| Voltage size D (cURus) | 300 V | Certificate No. (cURus) | E60693 |

WFS 4 100-250V DB

Weidmüller Interface GmbH & Co. KG
Klingenbergstraße 26
D-32758 Detmold
Germany

www.weidmueller.com

Technical data

| | |
|---|---|
| Conductor size Field wiring min. (cURus) 22 AWG | Conductor size Factory wiring min. (cURus) 22 AWG |
| Current size B (cURus) 10 A | Current size D (cURus) 10 A |
| Conductor size Field wiring max. (cURus) 10 AWG | |

Important note

Product information The voltage depends on the selected fuse element or the selected indicator light

Classifications

| | | | |
|-------------|-------------|-------------|-------------|
| ETIM 8.0 | EC000899 | ETIM 9.0 | EC000899 |
| ETIM 10.0 | EC000899 | ECLASS 14.0 | 27-25-01-13 |
| ECLASS 15.0 | 27-25-01-13 | | |



WFS 4 100-250V DB

Weidmüller Interface GmbH & Co. KG
 Klingenbergstraße 26
 D-32758 Detmold
 Germany

Accessories

www.weidmueller.com

End plates and partition plates



Partition plates and end plates are essential accessories for terminal blocks. Partition plates provide optical and electrical separation of different potentials and functional groups, increasing safety and ensuring a clear structure inside the control cabinet. End plates close the terminal block row on the sides, protect against contact with live parts, and ensure a clean, stable finish. Both components are precisely matched to the respective Weidmüller terminal block series, contributing to safe, compliant, and professional wiring.

General ordering data

| | | |
|------------|----------------------------|---|
| Type | WAP 2.5-10 | Version |
| Order No. | 1050000000 | End plate for terminals, dark beige, Height: 56 mm, Width: 1.5 mm, |
| GTIN (EAN) | 4008190103149 | V-0, Wemid, Snap-on: No |
| Qty. | 50 ST | |
| Type | WAP 2.5-10 BL | Version |
| Order No. | 1050080000 | End plate for terminals, blue, Height: 56 mm, Width: 1.5 mm, V-0, |
| GTIN (EAN) | 4008190136611 | Wemid, Snap-on: No |
| Qty. | 50 ST | |
| Type | WAP 2.5-10 BR | Version |
| Order No. | 1050070000 | End plate for terminals, brown, Height: 56 mm, Width: 1.5 mm, V-0, |
| GTIN (EAN) | 4008190455507 | Wemid, Snap-on: No |
| Qty. | 50 ST | |
| Type | WAP 2.5-10 GE | Version |
| Order No. | 1050020000 | End plate for terminals, yellow, Height: 56 mm, Width: 1.5 mm, V-0, |
| GTIN (EAN) | 4008190406776 | Wemid, Snap-on: No |
| Qty. | 50 ST | |
| Type | WAP 2.5-10 GN | Version |
| Order No. | 1072200000 | End plate for terminals, green, Height: 56 mm, Width: 1.5 mm, V-0, |
| GTIN (EAN) | 4008190455491 | Wemid, Snap-on: No |
| Qty. | 50 ST | |
| Type | WAP 2.5-10 GR | Version |
| Order No. | 1050050000 | End plate for terminals, grey, Height: 56 mm, Width: 1.5 mm, V-0, |
| GTIN (EAN) | 4008190455484 | Wemid, Snap-on: No |
| Qty. | 50 ST | |
| Type | WAP 2.5-10 OR | Version |
| Order No. | 1050060000 | End plate for terminals, orange, Height: 56 mm, Width: 1.5 mm, V-0, |
| GTIN (EAN) | 4008190406769 | Wemid, Snap-on: No |
| Qty. | 50 ST | |
| Type | WAP 2.5-10 RT | Version |
| Order No. | 1050040000 | End plate for terminals, red, Height: 56 mm, Width: 1.5 mm, V-0, |
| GTIN (EAN) | 4008190406783 | Wemid, Snap-on: No |
| Qty. | 50 ST | |
| Type | WAP 2.5-10 SW | Version |
| Order No. | 1050010000 | End plate for terminals, black, Height: 56 mm, Width: 1.5 mm, V-0, |
| GTIN (EAN) | 4008190406806 | Wemid, Snap-on: No |
| Qty. | 50 ST | |
| Type | WAP 2.5-10 VI | Version |
| Order No. | 1072210000 | End plate for terminals, violet, Height: 56 mm, Width: 1.5 mm, V-0, |
| GTIN (EAN) | 4008190455460 | Wemid, Snap-on: No |
| Qty. | 50 ST | |

WFS 4 100-250V DB

Weidmüller Interface GmbH & Co. KG

Klingenbergstraße 26

D-32758 Detmold

Germany

www.weidmueller.com

Accessories

| | | |
|------------|----------------------------|--|
| Type | WAP 2.5-10 WS | Version |
| Order No. | 1050090000 | End plate for terminals, white, Height: 56 mm, Width: 1.5 mm, V-0, |
| GTIN (EAN) | 4008190406790 | Wemid, Snap-on: No |
| Qty. | 50 ST | |

Cross-connections



The distribution or multiplication of a potential to adjoining terminal blocks is realized via a cross-connection. Additional wiring effort can be easily avoided. Even if the poles are broken out, contact reliability in the terminal blocks is still ensured. Our portfolio offers pluggable and screwable cross-connection systems for modular terminal blocks.

General ordering data

| | | |
|------------|----------------------------|---|
| Type | ZQV 4N/10 RD | Version |
| Order No. | 2460740000 | Cross-connector (terminal), Plugged, red, 32 A, Number of poles: 10, |
| GTIN (EAN) | 4050118476163 | Pitch in mm (P): 6.10, Insulated: Yes, Width: 58.7 mm |
| Qty. | 20 ST | |
| Type | ZQV 4N/2 | Version |
| Order No. | 1527930000 | Cross-connector (terminal), Plugged, orange, 32 A, Number of poles: 2, |
| GTIN (EAN) | 4050118332766 | Pitch in mm (P): 6.10, Insulated: Yes, Width: 9.9 mm |
| Qty. | 60 ST | |
| Type | ZQV 4N/2 BL | Version |
| Order No. | 1528040000 | Cross-connector (terminal), Plugged, blue, 32 A, Number of poles: 2, |
| GTIN (EAN) | 4050118332773 | Pitch in mm (P): 6.10, Insulated: Yes, Width: 9.9 mm |
| Qty. | 60 ST | |
| Type | ZQV 4N/2 RD | Version |
| Order No. | 2460450000 | Cross-connector (terminal), Plugged, red, 32 A, Number of poles: 2, |
| GTIN (EAN) | 4050118476149 | Pitch in mm (P): 6.10, Insulated: Yes, Width: 9.9 mm |
| Qty. | 60 ST | |
| Type | ZQV 4N/3 | Version |
| Order No. | 1527940000 | Cross-connector (terminal), Plugged, orange, 32 A, Number of poles: 3, |
| GTIN (EAN) | 4050118332865 | Pitch in mm (P): 6.10, Insulated: Yes, Width: 16 mm |
| Qty. | 60 ST | |
| Type | ZQV 4N/3 BL | Version |
| Order No. | 1528080000 | Cross-connector (terminal), Plugged, blue, 32 A, Number of poles: 3, |
| GTIN (EAN) | 4050118333008 | Pitch in mm (P): 6.10, Insulated: Yes, Width: 16 mm |
| Qty. | 60 ST | |
| Type | ZQV 4N/10 | Version |
| Order No. | 1528090000 | Cross-connector (terminal), Plugged, orange, 32 A, Number of poles: 10, |
| GTIN (EAN) | 4050118332896 | Pitch in mm (P): 6.10, Insulated: Yes, Width: 58.7 mm |
| Qty. | 20 ST | |
| Type | ZQV 4N/10 BL | Version |
| Order No. | 1528230000 | Cross-connector (terminal), Plugged, blue, 32 A, Number of poles: 10, |
| GTIN (EAN) | 4050118333138 | Pitch in mm (P): 6.10, Insulated: Yes, Width: 58.7 mm |
| Qty. | 20 ST | |

WFS 4 100-250V DB

Weidmüller Interface GmbH & Co. KG

Klingenbergstraße 26
D-32758 Detmold
Germany

www.weidmueller.com

Accessories

| | | |
|------------|----------------------------|---|
| Type | ZQV 4N/3 RD | Version |
| Order No. | 2460810000 | Cross-connector (terminal), Plugged, red, 32 A, Number of poles: 3, |
| GTIN (EAN) | 4050118476231 | Pitch in mm (P): 6.10, Insulated: Yes, Width: 16 mm |
| Qty. | 60 ST | |
| Type | ZQV 4N/30 | Version |
| Order No. | 2561580000 | Cross-connector (terminal), Plugged, orange, 32 A, Number of poles: |
| GTIN (EAN) | 4050118570113 | 30, Pitch in mm (P): 6.10, Insulated: Yes, Width: 181.7 mm |
| Qty. | 5 ST | |
| Type | ZQV 4N/30 BL | Version |
| Order No. | 2561610000 | Cross-connector (terminal), Plugged, blue, 32 A, Number of poles: 30, |
| GTIN (EAN) | 4050118569971 | Pitch in mm (P): 6.10, Insulated: Yes, Width: 181.7 mm |
| Qty. | 5 ST | |
| Type | ZQV 4N/30 RD | Version |
| Order No. | 2561600000 | Cross-connector (terminal), Plugged, red, 32 A, Number of poles: 30, |
| GTIN (EAN) | 4050118569964 | Pitch in mm (P): 6.10, Insulated: Yes, Width: 181.7 mm |
| Qty. | 5 ST | |
| Type | ZQV 4N/32 | Version |
| Order No. | 2561670000 | Cross-connector (terminal), Plugged, orange, 32 A, Number of poles: |
| GTIN (EAN) | 4050118570175 | 32, Pitch in mm (P): 6.10, Insulated: Yes, Width: 193.9 mm |
| Qty. | 5 ST | |
| Type | ZQV 4N/4 | Version |
| Order No. | 1527970000 | Cross-connector (terminal), Plugged, orange, 32 A, Number of poles: |
| GTIN (EAN) | 4050118332889 | 4, Pitch in mm (P): 6.10, Insulated: Yes, Width: 22.1 mm |
| Qty. | 60 ST | |
| Type | ZQV 4N/4 BL | Version |
| Order No. | 1528120000 | Cross-connector (terminal), Plugged, blue, 32 A, Number of poles: 4, |
| GTIN (EAN) | 4050118332872 | Pitch in mm (P): 6.10, Insulated: Yes, Width: 22.1 mm |
| Qty. | 60 ST | |
| Type | ZQV 4N/4 RD | Version |
| Order No. | 2460800000 | Cross-connector (terminal), Plugged, red, 32 A, Number of poles: 4, |
| GTIN (EAN) | 4050118476224 | Pitch in mm (P): 6.10, Insulated: Yes, Width: 22.1 mm |
| Qty. | 60 ST | |
| Type | ZQV 4N/5 | Version |
| Order No. | 1527980000 | Cross-connector (terminal), Plugged, orange, 32 A, Number of poles: |
| GTIN (EAN) | 4050118332759 | 5, Pitch in mm (P): 6.10, Insulated: Yes, Width: 28.2 mm |
| Qty. | 60 ST | |
| Type | ZQV 4N/5 BL | Version |
| Order No. | 1528140000 | Cross-connector (terminal), Plugged, blue, 32 A, Number of poles: 5, |
| GTIN (EAN) | 4050118333015 | Pitch in mm (P): 6.10, Insulated: Yes, Width: 28.2 mm |
| Qty. | 60 ST | |
| Type | ZQV 4N/5 RD | Version |
| Order No. | 2460790000 | Cross-connector (terminal), Plugged, red, 32 A, Number of poles: 5, |
| GTIN (EAN) | 4050118476217 | Pitch in mm (P): 6.10, Insulated: Yes, Width: 28.2 mm |
| Qty. | 60 ST | |
| Type | ZQV 4N/50 | Version |
| Order No. | 1528130000 | Cross-connector (terminal), Plugged, orange, 32 A, Number of poles: |
| GTIN (EAN) | 4050118332902 | 50, Pitch in mm (P): 6.10, Insulated: Yes, Width: 303.7 mm |
| Qty. | 5 ST | |
| Type | ZQV 4N/50 BL | Version |
| Order No. | 1528240000 | Cross-connector (terminal), Plugged, blue, 32 A, Number of poles: 50, |
| GTIN (EAN) | 4050118333121 | Pitch in mm (P): 6.10, Insulated: Yes, Width: 303.7 mm |
| Qty. | 5 ST | |

WFS 4 100-250V DB

Weidmüller Interface GmbH & Co. KG

Klingenbergstraße 26
D-32758 Detmold
Germany

www.weidmueller.com

Accessories

| | | |
|------------|----------------------------|--|
| Type | ZQV 4N/50 RD | Version |
| Order No. | 2460730000 | Cross-connector (terminal), Plugged, red, 32 A, Number of poles: 50, |
| GTIN (EAN) | 4050118476156 | Pitch in mm (P): 6.10, Insulated: Yes, Width: 303.7 mm |
| Qty. | 5 ST | |
| Type | ZQV 4N/6 | Version |
| Order No. | 1527990000 | Cross-connector (terminal), Plugged, orange, 32 A, Number of poles: |
| GTIN (EAN) | 4050118332919 | 6, Pitch in mm (P): 6.10, Insulated: Yes, Width: 34.3 mm |
| Qty. | 20 ST | |
| Type | ZQV 4N/6 BL | Version |
| Order No. | 1528170000 | Cross-connector (terminal), Plugged, blue, 32 A, Number of poles: 6, |
| GTIN (EAN) | 4050118332926 | Pitch in mm (P): 6.10, Insulated: Yes, Width: 34.3 mm |
| Qty. | 20 ST | |
| Type | ZQV 4N/6 RD | Version |
| Order No. | 2460780000 | Cross-connector (terminal), Plugged, red, 32 A, Number of poles: 6, |
| GTIN (EAN) | 4050118476200 | Pitch in mm (P): 6.10, Insulated: Yes, Width: 34.3 mm |
| Qty. | 20 ST | |
| Type | ZQV 4N/7 | Version |
| Order No. | 1528020000 | Cross-connector (terminal), Plugged, orange, 32 A, Number of poles: |
| GTIN (EAN) | 4050118332780 | 7, Pitch in mm (P): 6.10, Insulated: Yes, Width: 40.4 mm |
| Qty. | 20 ST | |
| Type | ZQV 4N/7 BL | Version |
| Order No. | 1528180000 | Cross-connector (terminal), Plugged, blue, 32 A, Number of poles: 7, |
| GTIN (EAN) | 4050118333114 | Pitch in mm (P): 6.10, Insulated: Yes, Width: 40.4 mm |
| Qty. | 20 ST | |
| Type | ZQV 4N/7 RD | Version |
| Order No. | 2460770000 | Cross-connector (terminal), Plugged, red, 32 A, Number of poles: 7, |
| GTIN (EAN) | 4050118476194 | Pitch in mm (P): 6.10, Insulated: Yes, Width: 40.4 mm |
| Qty. | 20 ST | |
| Type | ZQV 4N/8 | Version |
| Order No. | 1528030000 | Cross-connector (terminal), Plugged, orange, 32 A, Number of poles: |
| GTIN (EAN) | 4050118332841 | 8, Pitch in mm (P): 6.10, Insulated: Yes, Width: 46.5 mm |
| Qty. | 20 ST | |
| Type | ZQV 4N/8 BL | Version |
| Order No. | 1528190000 | Cross-connector (terminal), Plugged, blue, 32 A, Number of poles: 8, |
| GTIN (EAN) | 4050118332858 | Pitch in mm (P): 6.10, Insulated: Yes, Width: 46.5 mm |
| Qty. | 20 ST | |
| Type | ZQV 4N/8 RD | Version |
| Order No. | 2460760000 | Cross-connector (terminal), Plugged, red, 32 A, Number of poles: 8, |
| GTIN (EAN) | 4050118476187 | Pitch in mm (P): 6.10, Insulated: Yes, Width: 46.5 mm |
| Qty. | 20 ST | |
| Type | ZQV 4N/9 | Version |
| Order No. | 1528070000 | Cross-connector (terminal), Plugged, orange, 32 A, Number of poles: |
| GTIN (EAN) | 4050118332797 | 9, Pitch in mm (P): 6.10, Insulated: Yes, Width: 52.6 mm |
| Qty. | 20 ST | |
| Type | ZQV 4N/9 BL | Version |
| Order No. | 1528220000 | Cross-connector (terminal), Plugged, blue, 32 A, Number of poles: 9, |
| GTIN (EAN) | 4050118333107 | Pitch in mm (P): 6.10, Insulated: Yes, Width: 52.6 mm |
| Qty. | 20 ST | |
| Type | ZQV 4N/9 RD | Version |
| Order No. | 2460750000 | Cross-connector (terminal), Plugged, red, 32 A, Number of poles: 9, |
| GTIN (EAN) | 4050118476170 | Pitch in mm (P): 6.10, Insulated: Yes, Width: 52.6 mm |
| Qty. | 20 ST | |

WFS 4 100-250V DB

Weidmüller Interface GmbH & Co. KG

Klingenbergstraße 26

D-32758 Detmold

Germany

www.weidmueller.com

Accessories

End bracket

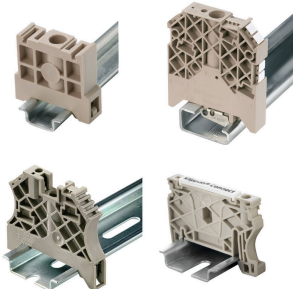

Weidmüller's range of products includes end brackets that guarantee a permanent, reliable mounting on the terminal rail and prevent sliding. Versions with and without screws are available. The end brackets include marking options, also for group markers, and also a test plug holder.

General ordering data

| | | |
|------------|----------------------------|--|
| Type | WEW 35/2 | Version |
| Order No. | 1061200000 | End bracket, dark beige, TS 35, HB, Wemid, Width: 8 mm, 100 °C |
| GTIN (EAN) | 4008190030230 | |
| Qty. | 50 ST | |
| Type | WEW 35/2 GR | Version |
| Order No. | 1859200000 | End bracket, grey, TS 35, V-2, Wemid, Width: 8 mm, 100 °C |
| GTIN (EAN) | 4032248411658 | |
| Qty. | 50 ST | |
| Type | WEW 35/2 SW | Version |
| Order No. | 1061210000 | End bracket, black, TS 35, V-2, Wemid, Width: 8 mm, 100 °C |
| GTIN (EAN) | 4032248136278 | |
| Qty. | 50 ST | |
| Type | WEW 35/2 VO GF SW | Version |
| Order No. | 1479000000 | End bracket, black, TS 35, V-0, Wemid, Width: 8 mm, 130 °C |
| GTIN (EAN) | 4050118286779 | |
| Qty. | 50 ST | |

WS 8/6



WS/ DEK

MultiMark terminal markers use an innovative composite material made from two components. The hard base contour of the marker snaps securely into the connector. The elastic surface finish makes the marker easy to mount. This specially punched material enables the strips to be stretched to accommodate the slight variations in spacing that tend to add up, especially with long terminal blocks. Another advantage: the excellent printability of the surface material guarantees durable and wear-resistant labelling. A print resolution of 300 dpi also produces a very legible script.

Your benefits with MultiMark

- Firm hold and durable printing
- Continuous strips save installation time
- Easy mounting thanks to an innovative composite material
- Large label field for optimal legibility
- High flexibility thanks to manufacturer independence

WFS 4 100-250V DB

Weidmüller Interface GmbH & Co. KG

Klingenbergstraße 26
D-32758 Detmold
Germany

www.weidmueller.com

Accessories

General ordering data

| | | |
|------------|----------------------------|---|
| Type | WS 8/6 MM WS | Version |
| Order No. | 2007160000 | WS, Terminal marker, 8 x 6 mm, Weidmueller, white |
| GTIN (EAN) | 4050118391879 | |
| Qty. | 600 ST | |

WS 12/6



WS/ DEK

MultiMark terminal markers use an innovative composite material made from two components. The hard base contour of the marker snaps securely into the connector. The elastic surface finish makes the marker easy to mount. This specially punched material enables the strips to be stretched to accommodate the slight variations in spacing that tend to add up, especially with long terminal blocks. Another advantage: the excellent printability of the surface material guarantees durable and wear-resistant labelling. A print resolution of 300 dpi also produces a very legible script.

Your benefits with MultiMark

- Firm hold and durable printing
- Continuous strips save installation time
- Easy mounting thanks to an innovative composite material
- Large label field for optimal legibility
- High flexibility thanks to manufacturer independence

General ordering data

| | | |
|------------|----------------------------|--|
| Type | WS 12/6 MM WS | Version |
| Order No. | 2007200000 | WS, Terminal marker, 12 x 6 mm, Weidmueller, white |
| GTIN (EAN) | 4050118391886 | |
| Qty. | 600 ST | |

DEK 5/6



WS/ DEK

MultiMark terminal markers use an innovative composite material made from two components. The hard base contour of the marker snaps securely into the connector. The elastic surface finish makes the marker easy to mount. This specially punched material enables the strips to be stretched to accommodate the slight variations in spacing that tend to add up, especially with long terminal blocks. Another advantage: the excellent printability of the surface material guarantees durable and wear-resistant labelling. A print resolution of 300 dpi also produces a very legible script.

Your benefits with MultiMark

- Firm hold and durable printing
- Continuous strips save installation time
- Easy mounting thanks to an innovative composite material
- Large label field for optimal legibility
- High flexibility thanks to manufacturer independence

WFS 4 100-250V DB

Weidmüller Interface GmbH & Co. KG

Klingenbergstraße 26

D-32758 Detmold

Germany

www.weidmueller.com

Accessories

General ordering data

| | | |
|------------|----------------------------|--|
| Type | DEK 5/6 MM WS | Version |
| Order No. | 2007120000 | Dekafix, Terminal marker, 5 x 6 mm, Weidmueller, white |
| GTIN (EAN) | 4050118392104 | |
| Qty. | 600 ST | |

Blank



The Dekafix (DEK) marker is the universal marker for all conductor and plug-in connectors as well as for electronic sub-assemblies. The system is ideal for short number sequences and covers a wide range of ready-printed markers.

Strips for fast installation in only one work step. The printing is easy to read, rich in contrast and available in various widths.

- Large range of ready-to-use markers
 - Strips for fast installation
 - Terminal markers, suitable for all Weidmüller cable connectors
 - Available as blank MultiCard or with standard printing
- For custom printing: Please send us a file of our labeling software M-Print PRO or M-Print PRO Online (without installation) for your labeling specifications.

General ordering data

| | | |
|------------|----------------------------|---|
| Type | DEK 5/6 MC NE BL | Version |
| Order No. | 1238290000 | Dekafix, Terminal marker, 5 x 6 mm, Pitch in mm (P): 6.00 |
| GTIN (EAN) | 4050118267327 | Weidmueller, blue |
| Qty. | 1000 ST | |
| Type | DEK 5/6 MC NE BR | Version |
| Order No. | 1454900000 | Dekafix, Terminal marker, 5 x 6 mm, Pitch in mm (P): 6.00 |
| GTIN (EAN) | 4050118323313 | Weidmueller, brown |
| Qty. | 1000 ST | |
| Type | DEK 5/6 MC NE GE | Version |
| Order No. | 1238280000 | Dekafix, Terminal marker, 5 x 6 mm, Pitch in mm (P): 6.00 |
| GTIN (EAN) | 4050118038750 | Weidmueller, yellow |
| Qty. | 1000 ST | |
| Type | DEK 5/6 MC NE GN | Version |
| Order No. | 1238310000 | Dekafix, Terminal marker, 5 x 6 mm, Pitch in mm (P): 6.00 |
| GTIN (EAN) | 4050118271812 | Weidmueller, green |
| Qty. | 1000 ST | |
| Type | DEK 5/6 MC NE GR | Version |
| Order No. | 1238330000 | Dekafix, Terminal marker, 5 x 6 mm, Pitch in mm (P): 6.00 |
| GTIN (EAN) | 4050118323306 | Weidmueller, grey |
| Qty. | 1000 ST | |
| Type | DEK 5/6 MC NE OR | Version |
| Order No. | 1912090000 | Dekafix, Terminal marker, 5 x 6 mm, Pitch in mm (P): 6.00 |
| GTIN (EAN) | 4032248540525 | Weidmueller, orange |
| Qty. | 1000 ST | |
| Type | DEK 5/6 MC NE WS | Version |
| Order No. | 1609820000 | Dekafix, Terminal marker, 5 x 6 mm, Pitch in mm (P): 6.00 |
| GTIN (EAN) | 4008190203436 | Weidmueller, white |
| Qty. | 1000 ST | |

WFS 4 100-250V DB

Weidmüller Interface GmbH & Co. KG

Klingenbergstraße 26

D-32758 Detmold

Germany

Accessories

www.weidmueller.com

Custom printing



The Dekafix (DEK) marker is the universal marker for all conductor and plug-in connectors as well as for electronic sub-assemblies. The system is ideal for short number sequences and covers a wide range of ready-printed markers.

Strips for fast installation in only one work step. The printing is easy to read, rich in contrast and available in various widths.

- Large range of ready-to-use markers
 - Strips for fast installation
 - Terminal markers, suitable for all Weidmüller cable connectors
 - Available as blank MultiCard or with standard printing
- For custom printing: Please send us a file of our labeling software M-Print PRO or M-Print PRO Online (without installation) for your labeling specifications.

General ordering data

| | | | |
|------------|----------------------------|---------|---|
| Type | DEK 5/6 MC SDR | Version | |
| Order No. | 1609830000 | | Dekafix, Terminal marker, 5 x 6 mm, Pitch in mm (P): 6.00 |
| GTIN (EAN) | 4008190456603 | | Weidmueller, To customer specification |
| Qty. | 200 ST | | |

Plus



The Dekafix (DEK) marker is the universal marker for all conductor and plug-in connectors as well as for electronic sub-assemblies. The system is ideal for short number sequences and covers a wide range of ready-printed markers.

Strips for fast installation in only one work step. The printing is easy to read, rich in contrast and available in various widths.

- Large range of ready-to-use markers
 - Strips for fast installation
 - Terminal markers, suitable for all Weidmüller cable connectors
 - Available as blank MultiCard or with standard printing
- For custom printing: Please send us a file of our labeling software M-Print PRO or M-Print PRO Online (without installation) for your labeling specifications.

General ordering data

| | | | |
|------------|----------------------------|---------|---|
| Type | DEK 5/6 PLUS MC NE WS | Version | |
| Order No. | 1011320000 | | Dekafix, Terminal marker, 5 x 6 mm, Pitch in mm (P): 6.00 |
| GTIN (EAN) | 4032248717644 | | Weidmueller, white |
| Qty. | 1000 ST | | |

WFS 4 100-250V DB

Weidmüller Interface GmbH & Co. KG
 Klingenbergstraße 26
 D-32758 Detmold
 Germany

Accessories

www.weidmueller.com

Custom printing



The Dekafix (DEK) marker is the universal marker for all conductor and plug-in connectors as well as for electronic sub-assemblies. The system is ideal for short number sequences and covers a wide range of ready-printed markers.

Strips for fast installation in only one work step. The printing is easy to read, rich in contrast and available in various widths.

- Large range of ready-to-use markers
 - Strips for fast installation
 - Terminal markers, suitable for all Weidmüller cable connectors
 - Available as blank MultiCard or with standard printing
- For custom printing: Please send us a file of our labeling software M-Print PRO or M-Print PRO Online (without installation) for your labeling specifications.

General ordering data

| | | |
|------------|----------------------------|---|
| Type | DEK 5/6 PLUS MC SDR | Version |
| Order No. | 1038650000 | Dekafix, Terminal marker, 5 x 6 mm, Pitch in mm (P): 6.00 |
| GTIN (EAN) | 4032248767908 | Weidmueller, To customer specification |
| Qty. | 200 ST | |

Blank



WS markers are the perfect match for the W-series connectors. Thanks to their system compatibility, the WS tags can also be used with the I-series and the Z-series. The large marking surfaces do not only permit long character strings but also multi-line text. WS markers are ideal for labels with long, customised character strings. Thanks to the proven MultiCard format, printing with PrintJet CONNECT oder/or Plotter is possible.

- Can be fitted in strips or individually
- Markers in proven MultiCard format

For custom printing: Please send us a file of our labeling software M-Print PRO or M-Print PRO Online (without installation) for your labeling specifications.

General ordering data

| | | |
|------------|----------------------------|--|
| Type | WS 10/6 M MC NE WS | Version |
| Order No. | 1818400000 | WS, Terminal marker, 10 x 6 mm, Pitch in mm (P): 6.00 Weidmueller, |
| GTIN (EAN) | 4032248310876 | Allen-Bradley, white |
| Qty. | 600 ST | |
| Type | WS 10/6 M PLUS MC NE WS | Version |
| Order No. | 2003780000 | WS, Terminal marker, 10 x 6 mm, Pitch in mm (P): 6.00 Weidmueller, |
| GTIN (EAN) | 4050118424461 | Allen-Bradley, white |
| Qty. | 600 ST | |

WFS 4 100-250V DB

Weidmüller Interface GmbH & Co. KG

Klingenbergstraße 26

D-32758 Detmold

Germany

www.weidmueller.com

Accessories

Custom printing



WS markers are the perfect match for the W-series connectors. Thanks to their system compatibility, the WS tags can also be used with the I-series and the Z-series. The large marking surfaces do not only permit long character strings but also multi-line text. WS markers are ideal for labels with long, customised character strings. Thanks to the proven MultiCard format, printing with PrintJet CONNECT oder/or Plotter is possible.

- Can be fitted in strips or individually
- Markers in proven MultiCard format

For custom printing: Please send us a file of our labeling software M-Print PRO or M-Print PRO Online (without installation) for your labeling specifications.

General ordering data

| | | |
|------------|----------------------------|--|
| Type | WS 10/6 M PLUS MC SDR | Version |
| Order No. | 2007780000 | WS, Terminal marker, 10 x 6 mm, Pitch in mm (P): 6.00 Weidmueller, |
| GTIN (EAN) | 4050118393187 | Allen-Bradley, To customer specification |
| Qty. | 120 ST | |

Blank



WS markers are the perfect match for the W-series connectors. Thanks to their system compatibility, the WS tags can also be used with the I-series and the Z-series. The large marking surfaces do not only permit long character strings but also multi-line text. WS markers are ideal for labels with long, customised character strings. Thanks to the proven MultiCard format, printing with PrintJet CONNECT oder/or Plotter is possible.

- Can be fitted in strips or individually
- Markers in proven MultiCard format

For custom printing: Please send us a file of our labeling software M-Print PRO or M-Print PRO Online (without installation) for your labeling specifications.

General ordering data

| | | |
|------------|----------------------------|--|
| Type | WS 10/6 MC M NE BL | Version |
| Order No. | 1069080000 | WS, Terminal marker, 10 x 6 mm, Pitch in mm (P): 6.00 Weidmueller, |
| GTIN (EAN) | 4032248824618 | Allen-Bradley, blue |
| Qty. | 600 ST | |
| Type | WS 10/6 MC M NE GE | Version |
| Order No. | 1917430000 | WS, Terminal marker, 10 x 6 mm, Pitch in mm (P): 6.00 Weidmueller, |
| GTIN (EAN) | 4032248551637 | Allen-Bradley, yellow |
| Qty. | 600 ST | |
| Type | WS 10/6 MC M NE GN | Version |
| Order No. | 1917420000 | WS, Terminal marker, 10 x 6 mm, Pitch in mm (P): 6.00 Weidmueller, |
| GTIN (EAN) | 4032248551620 | Allen-Bradley, green |
| Qty. | 600 ST | |

WFS 4 100-250V DB

Weidmüller Interface GmbH & Co. KG

Klingenbergstraße 26

D-32758 Detmold

Germany

www.weidmueller.com

Accessories

| | | |
|------------|----------------------------|--|
| Type | WS 10/6 MC M NE RT | Version |
| Order No. | 1917440000 | WS, Terminal marker, 10 x 6 mm, Pitch in mm (P): 6.00 Weidmueller, |
| GTIN (EAN) | 4032248551644 | Allen-Bradley, red |
| Qty. | 600 ST | |

Custom printing



WS markers are the perfect match for the W-series connectors. Thanks to their system compatibility, the WS tags can also be used with the I-series and the Z-series. The large marking surfaces do not only permit long character strings but also multi-line text. WS markers are ideal for labels with long, customised character strings. Thanks to the proven MultiCard format, printing with PrintJet CONNECT oder/or Plotter is possible.

- Can be fitted in strips or individually
- Markers in proven MultiCard format

For custom printing: Please send us a file of our labeling software M-Print PRO or M-Print PRO Online (without installation) for your labeling specifications.

General ordering data

| | | |
|------------|----------------------------|--|
| Type | WS 10/6 MC M SDR | Version |
| Order No. | 1818410000 | WS, Terminal marker, 10 x 6 mm, Pitch in mm (P): 6.00 Weidmueller, |
| GTIN (EAN) | 4032248310883 | Allen-Bradley, To customer specification |
| Qty. | 120 ST | |

Blank



WS markers are the perfect match for the W-series connectors. Thanks to their system compatibility, the WS tags can also be used with the I-series and the Z-series. The large marking surfaces do not only permit long character strings but also multi-line text. WS markers are ideal for labels with long, customised character strings. Thanks to the proven MultiCard format, printing with PrintJet CONNECT oder/or Plotter is possible.

- Can be fitted in strips or individually
- Markers in proven MultiCard format

For custom printing: Please send us a file of our labeling software M-Print PRO or M-Print PRO Online (without installation) for your labeling specifications.

General ordering data

| | | |
|------------|----------------------------|--|
| Type | WS 10/6 MC NE WS | Version |
| Order No. | 1828450000 | WS, Terminal marker, 10 x 6 mm, Pitch in mm (P): 6.00 Weidmueller, |
| GTIN (EAN) | 4032248350513 | Allen-Bradley, white |
| Qty. | 600 ST | |

WFS 4 100-250V DB

Weidmüller Interface GmbH & Co. KG
 Klingenbergstraße 26
 D-32758 Detmold
 Germany

www.weidmueller.com

Accessories

Custom printing

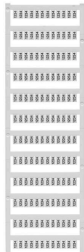

WS markers are the perfect match for the W-series connectors. Thanks to their system compatibility, the WS tags can also be used with the I-series and the Z-series. The large marking surfaces do not only permit long character strings but also multi-line text. WS markers are ideal for labels with long, customised character strings. Thanks to the proven MultiCard format, printing with PrintJet CONNECT oder/or Plotter is possible.

- Can be fitted in strips or individually
- Markers in proven MultiCard format

For custom printing: Please send us a file of our labeling software M-Print PRO or M-Print PRO Online (without installation) for your labeling specifications.

General ordering data

| | | |
|------------|----------------------------|--|
| Type | WS 10/6 MC SDR | Version |
| Order No. | 1828460000 | WS, Terminal marker, 10 x 6 mm, Pitch in mm (P): 6.00 Weidmueller, |
| GTIN (EAN) | 4032248367399 | Allen-Bradley, To customer specification |
| Qty. | 120 ST | |

Blank



WS markers are the perfect match for the W-series connectors. Thanks to their system compatibility, the WS tags can also be used with the I-series and the Z-series. The large marking surfaces do not only permit long character strings but also multi-line text. WS markers are ideal for labels with long, customised character strings. Thanks to the proven MultiCard format, printing with PrintJet CONNECT oder/or Plotter is possible.

- Can be fitted in strips or individually
- Markers in proven MultiCard format

For custom printing: Please send us a file of our labeling software M-Print PRO or M-Print PRO Online (without installation) for your labeling specifications.

General ordering data

| | | |
|------------|----------------------------|--|
| Type | WS 10/6 PLUS MC NE WS | Version |
| Order No. | 1046390000 | WS, Terminal marker, 10 x 6 mm, Pitch in mm (P): 6.00 Weidmueller, |
| GTIN (EAN) | 4032248782109 | Allen-Bradley, white |
| Qty. | 600 ST | |

WFS 4 100-250V DB

Weidmüller Interface GmbH & Co. KG

Klingenbergstraße 26

D-32758 Detmold

Germany

www.weidmueller.com

Accessories

Custom printing



WS markers are the perfect match for the W-series connectors. Thanks to their system compatibility, the WS tags can also be used with the I-series and the Z-series. The large marking surfaces do not only permit long character strings but also multi-line text. WS markers are ideal for labels with long, customised character strings. Thanks to the proven MultiCard format, printing with PrintJet CONNECT oder/or Plotter is possible.

- Can be fitted in strips or individually
- Markers in proven MultiCard format

For custom printing: Please send us a file of our labeling software M-Print PRO or M-Print PRO Online (without installation) for your labeling specifications.

General ordering data

| | | |
|------------|----------------------------|--|
| Type | WS 10/6 PLUS MC SDR | Version |
| Order No. | 1046330000 | WS, Terminal marker, 10 x 6 mm, Pitch in mm (P): 6.00 Weidmueller, |
| GTIN (EAN) | 4032248782031 | Allen-Bradley, To customer specification |
| Qty. | 120 ST | |

Blank



WS markers are the perfect match for the W-series connectors. Thanks to their system compatibility, the WS tags can also be used with the I-series and the Z-series. The large marking surfaces do not only permit long character strings but also multi-line text. WS markers are ideal for labels with long, customised character strings. Thanks to the proven MultiCard format, printing with PrintJet CONNECT oder/or Plotter is possible.

- Can be fitted in strips or individually
- Markers in proven MultiCard format

For custom printing: Please send us a file of our labeling software M-Print PRO or M-Print PRO Online (without installation) for your labeling specifications.

General ordering data

| | | |
|------------|----------------------------|--|
| Type | WS 12/6 MC NE BL | Version |
| Order No. | 1773551693 | WS, Terminal marker, 12 x 6 mm, Pitch in mm (P): 6.00 Weidmueller, |
| GTIN (EAN) | 4032248143269 | Allen-Bradley, blue |
| Qty. | 600 ST | |
| Type | WS 12/6 MC NE BR | Version |
| Order No. | 1773551692 | WS, Terminal marker, 12 x 6 mm, Pitch in mm (P): 6.00 Weidmueller, |
| GTIN (EAN) | 4032248143252 | Allen-Bradley, brown |
| Qty. | 600 ST | |
| Type | WS 12/6 MC NE GE | Version |
| Order No. | 1773551687 | WS, Terminal marker, 12 x 6 mm, Pitch in mm (P): 6.00 Weidmueller, |
| GTIN (EAN) | 4032248141937 | Allen-Bradley, yellow |
| Qty. | 600 ST | |

WFS 4 100-250V DB

Weidmüller Interface GmbH & Co. KG
 Klingenbergstraße 26
 D-32758 Detmold
 Germany

www.weidmueller.com

Accessories

| | | |
|------------|----------------------------|--|
| Type | WS 12/6 MC NE OR | Version |
| Order No. | 1773551690 | WS, Terminal marker, 12 x 6 mm, Pitch in mm (P): 6.00 Weidmueller, |
| GTIN (EAN) | 4032248143245 | Allen-Bradley, orange |
| Qty. | 600 ST | |
| Type | WS 12/6 MC NE RT | Version |
| Order No. | 1773551686 | WS, Terminal marker, 12 x 6 mm, Pitch in mm (P): 6.00 Weidmueller, |
| GTIN (EAN) | 4032248141920 | Allen-Bradley, red |
| Qty. | 600 ST | |
| Type | WS 12/6 MC NE VI | Version |
| Order No. | 1773551689 | WS, Terminal marker, 12 x 6 mm, Pitch in mm (P): 6.00 Weidmueller, |
| GTIN (EAN) | 4032248143238 | Allen-Bradley, violet |
| Qty. | 600 ST | |
| Type | WS 12/6 MC NE WS | Version |
| Order No. | 1609900000 | WS, Terminal marker, 12 x 6 mm, Pitch in mm (P): 6.00 Weidmueller, |
| GTIN (EAN) | 4008190203467 | Allen-Bradley, white |
| Qty. | 600 ST | |

Custom printing



WS markers are the perfect match for the W-series connectors. Thanks to their system compatibility, the WS tags can also be used with the I-series and the Z-series. The large marking surfaces do not only permit long character strings but also multi-line text. WS markers are ideal for labels with long, customised character strings. Thanks to the proven MultiCard format, printing with PrintJet CONNECT oder/or Plotter is possible.

- Can be fitted in strips or individually
- Markers in proven MultiCard format

For custom printing: Please send us a file of our labeling software M-Print PRO or M-Print PRO Online (without installation) for your labeling specifications.

General ordering data

| | | |
|------------|----------------------------|--|
| Type | WS 12/6 MC SDR | Version |
| Order No. | 1609910000 | WS, Terminal marker, 12 x 6 mm, Pitch in mm (P): 6.00 Weidmueller, |
| GTIN (EAN) | 4008190456658 | Allen-Bradley, To customer specification |
| Qty. | 120 ST | |

WFS 4 100-250V DB

Weidmüller Interface GmbH & Co. KG
 Klingenbergstraße 26
 D-32758 Detmold
 Germany

www.weidmueller.com

Accessories

Blank



WS markers are the perfect match for the W-series connectors. Thanks to their system compatibility, the WS tags can also be used with the I-series and the Z-series. The large marking surfaces do not only permit long character strings but also multi-line text. WS markers are ideal for labels with long, customised character strings. Thanks to the proven MultiCard format, printing with PrintJet CONNECT oder/or Plotter is possible.

- Can be fitted in strips or individually
- Markers in proven MultiCard format

For custom printing: Please send us a file of our labeling software M-Print PRO or M-Print PRO Online (without installation) for your labeling specifications.

General ordering data

| | | |
|------------|----------------------------|--|
| Type | WS 12/6 PLUS MC NE WS | Version |
| Order No. | 1927530000 | WS, Terminal marker, 12 x 6 mm, Pitch in mm (P): 6.00 Weidmueller, |
| GTIN (EAN) | 4032248574209 | Allen-Bradley, white |
| Qty. | 600 ST | |

Custom printing

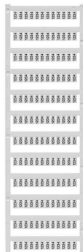

WS markers are the perfect match for the W-series connectors. Thanks to their system compatibility, the WS tags can also be used with the I-series and the Z-series. The large marking surfaces do not only permit long character strings but also multi-line text. WS markers are ideal for labels with long, customised character strings. Thanks to the proven MultiCard format, printing with PrintJet CONNECT oder/or Plotter is possible.

- Can be fitted in strips or individually
- Markers in proven MultiCard format

For custom printing: Please send us a file of our labeling software M-Print PRO or M-Print PRO Online (without installation) for your labeling specifications.

General ordering data

| | | |
|------------|----------------------------|--|
| Type | WS 12/6 PLUS MC SDR | Version |
| Order No. | 1927540000 | WS, Terminal marker, 12 x 6 mm, Pitch in mm (P): 6.00 Weidmueller, |
| GTIN (EAN) | 4032248574711 | Allen-Bradley, To customer specification |
| Qty. | 120 ST | |

WFS 4 100-250V DB

Weidmüller Interface GmbH & Co. KG
 Klingenbergstraße 26
 D-32758 Detmold
 Germany

www.weidmueller.com

Accessories

Blank

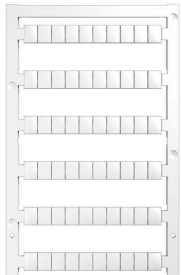

WS markers are the perfect match for the W-series connectors. Thanks to their system compatibility, the WS tags can also be used with the I-series and the Z-series. The large marking surfaces do not only permit long character strings but also multi-line text. WS markers are ideal for labels with long, customised character strings. Thanks to the proven MultiCard format, printing with PrintJet CONNECT oder/or Plotter is possible.

- Can be fitted in strips or individually
- Markers in proven MultiCard format

For custom printing: Please send us a file of our labeling software M-Print PRO or M-Print PRO Online (without installation) for your labeling specifications.

General ordering data

| | | |
|------------|----------------------------|---|
| Type | WS 8/6 PLUS MC NE WS | Version |
| Order No. | 1951880000 | WS, Terminal marker, 8 x 6 mm, Pitch in mm (P): 6.00 Weidmueller, |
| GTIN (EAN) | 4032248632114 | white |
| Qty. | 600 ST | |

Custom printing



WS markers are the perfect match for the W-series connectors. Thanks to their system compatibility, the WS tags can also be used with the I-series and the Z-series. The large marking surfaces do not only permit long character strings but also multi-line text. WS markers are ideal for labels with long, customised character strings. Thanks to the proven MultiCard format, printing with PrintJet CONNECT oder/or Plotter is possible.

- Can be fitted in strips or individually
- Markers in proven MultiCard format

For custom printing: Please send us a file of our labeling software M-Print PRO or M-Print PRO Online (without installation) for your labeling specifications.

General ordering data

| | | |
|------------|----------------------------|---|
| Type | WS 8/6 PLUS MC SDR | Version |
| Order No. | 1038820000 | WS, Terminal marker, 8 x 6 mm, Pitch in mm (P): 6.00 Weidmueller, |
| GTIN (EAN) | 4032248768073 | To customer specification |
| Qty. | 120 ST | |

WFS 4 100-250V DB

Weidmüller Interface GmbH & Co. KG

Klingenbergstraße 26

D-32758 Detmold

Germany

www.weidmueller.com

Accessories

Marker holder



The marker holder offer the possibility of additional mounting of standard markers with a pitch of 5 or 5.1 mm. The angled holders can be optionally snapped together and could be mounted in all standard marking channels of the Klippon® Connect modular terminal blocks. Fitting marker types could be found under the respective accessories of the designation marking holder.

General ordering data

| | | |
|------------|----------------------------|----------------------------|
| Type | BZT 1 WS 10/5 | Version |
| Order No. | 1805490000 | Accessories, Marker holder |
| GTIN (EAN) | 4032248270231 | |
| Qty. | 100 ST | |

| | | |
|------------|----------------------------|----------------------------|
| Type | BZT 1 ZA WS 10/5 | Version |
| Order No. | 1805520000 | Accessories, Marker holder |
| GTIN (EAN) | 4032248270248 | |
| Qty. | 100 ST | |

End bracket

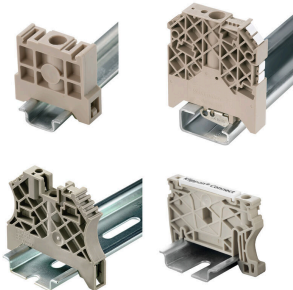

Weidmüller's range of products includes end brackets that guarantee a permanent, reliable mounting on the terminal rail and prevent sliding. Versions with and without screws are available. The end brackets include marking options, also for group markers, and also a test plug holder.

General ordering data

| | | |
|------------|----------------------------|---------------------------------|
| Type | ZST 1 | Version |
| Order No. | 1269070000 | Accessories, Accessories holder |
| GTIN (EAN) | 4050118094091 | |
| Qty. | 25 ST | |

Cross-connections

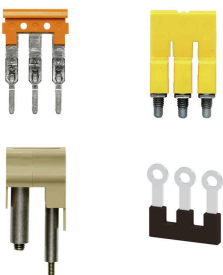

The distribution or multiplication of a potential to adjoining terminal blocks is realized via a cross-connection. Additional wiring effort can be easily avoided. Even if the poles are broken out, contact reliability in the terminal blocks is still ensured. Our portfolio offers pluggable and screwable cross-connection systems for modular terminal blocks.

WFS 4 100-250V DB

Weidmüller Interface GmbH & Co. KG
Klingenbergstraße 26
D-32758 Detmold
Germany

www.weidmueller.com

Accessories

General ordering data

| | | | |
|------------|----------------------------|------------|--|
| Type | VH 20/5/3.4 | Version | |
| Order No. | 0446100000 | Dummy fuse | |
| GTIN (EAN) | 4008190519742 | | |
| Qty. | 10 ST | | |