

ITS 24-240VUC M7C PU10

Weidmüller Interface GmbH & Co. KG
 Klingenbergstraße 26
 D-32758 Detmold
 Germany

www.weidmueller.com

Product image

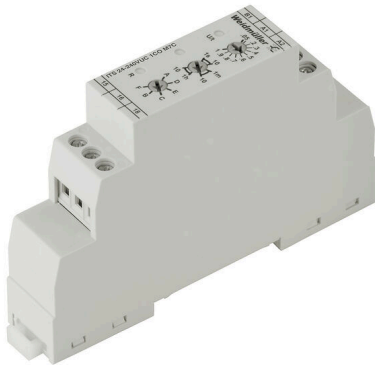

Similar to illustration

Compact multi-functional timing relay for easy control signal adjustment

With IT-TIMER, Weidmüller's range includes a highly efficient timing relay with multi-voltage input that combines a range of functions with a compact size. It is particularly easy to configure the timer functions thanks to the flat front cover, the easy-to-read LED status indicator and operation with standard tools. IT-TIMER meets the requirements of IEC 618121. It is designed for an operating voltage range from 24 V DC to 48 V DC or 24 V AC to 240 V AC and can therefore be used in a wide variety of applications.

- High level of functionality in a compact size
- Timing functions that are easy to configure using standard tools
- Can be used internationally thanks to compliance with EN 618121
- Seven timing functions for a wide range of applications make the IT-TIMER a smart solution for your application

General ordering data

Version	IT TIMER, Multifunction timing relay, with separate control input, Number of contacts: 1, CO contact, AgNi, Rated control voltage: 24...48 V DC, 24...230 V AC, Continuous current: 5 A, Screw connection
Order No.	2545120000
Type	ITS 24-240VUC M7C PU10
GTIN (EAN)	4050118555066
Qty.	10 items

ITS 24-240VUC M7C PU10

Weidmüller Interface GmbH & Co. KG
Klingenbergstraße 26
D-32758 Detmold
Germany

www.weidmueller.com

Technical data

Approvals

Approvals



ROHS Conform

Dimensions and weights

Depth	57.9 mm	Depth (inches)	2.2795 inch
Height	98 mm	Height (inches)	3.8583 inch
Width	17.5 mm	Width (inches)	0.689 inch
Net weight	48.2 g		

Temperatures

Storage temperature	-40 °C...70 °C	Ambient temperature	-25 °C...50 °C
Operating temperature		Humidity	25 - 75%, no condensation

Environmental Product Compliance

RoHS Compliance Status	Compliant without exemption
REACH SVHC	No SVHC above 0.1 wt%

Control side

Rated control voltage	24...48 V DC, 24...230 V AC	Power rating	8 VA @ 230 V AC, 0.4 W at 24 V DC
Status indicator	LED green (U/t): flashes when time runs, lights permanently with supply voltage applied, LED yellow (R): relay closed	Time ranges	0.05 s - 1 s, 0.5 s - 10 s, 3 s - 60 s, 0.5 min - 10 min, 3 min - 1 h, 0.5 h - 10 h
Setting tolerance	5 %	Max. reset time after voltage interruption	100 ms
Basic accuracy	±6% (of scale-end value, for time range 0.05 s - 1 s), ±1.5% (of scale-end value, for all other time ranges)	Min. pulse duration	50 ms
Repeat accuracy	<0.5 % or ±5 ms		

Load side

Rated switching voltage	250 V AC	Continuous current	5 A
Max. switching voltage, AC	250 V	Max. switching voltage, DC	30 V
AC switching capacity (resistive), max.	1250 VA	DC switching capacity (resistive), max.	90 W
Contact type	1 CO contact (AgNi)	Mechanical service life	1 x 10 ⁶ switching cycles
Min. switching power	10 mA @ 12 V, 100 mA @ 5 V		

General data

Design	Installation housing; 1TE	Suitable for front mounting	No
Version	with separate control input	Mounting rail	TS 35
Test button available	No	Mechanical switch position indicator	No
Resistance to vibration EN 61812-1	10 Hz...60 Hz: 0.15 mm, 60 Hz...150 Hz: 2 g		

ITS 24-240VUC M7C PU10

Weidmüller Interface GmbH & Co. KG
 Klingenbergstraße 26
 D-32758 Detmold
 Germany

www.weidmueller.com

Technical data

Insulation coordination

Rated voltage	300 V	Pollution severity	2
Surge voltage category	II	Clearance and creepage distances for control side - load side	≥ 1.5 mm
Dielectric strength for control side - load side	1.6 kV	Impulse withstand voltage	2.5 kV
Protection degree	IP20		

Connection data

Wire connection method	Screw connection	Stripping length, rated connection	7 mm
Tightening torque, max.	0.5 Nm	Clamping range, rated connection	2.5 mm ²
Clamping range, min.	0.25 mm ²	Clamping range, max.	2.5 mm ²
Wire connection cross section AWG, min.	AWG 23	Wire connection cross section AWG, max.	AWG 14
Wire cross-section, solid, min.	0.25 mm ²	Wire cross-section, solid, max.	2.5 mm ²
Wire connection cross section, finely stranded, min.	0.25 mm ²	Wire connection cross section, finely stranded, max.	2.5 mm ²
Wire connection cross-section, finely stranded with wire-end ferrules DIN 46228/4, min.	0.25 mm ²	Wire connection cross-section, finely stranded with wire-end ferrules DIN 46228/4, max.	2.5 mm ²
Conductor cross-section, flexible, AEH (DIN 46228-1), min.	0.25 mm ²	Conductor cross-section, flexible, AEH (DIN 46228-1), max.	2.5 mm ²
Blade size	size PH1		

Classifications

ETIM 8.0	EC001439	ETIM 9.0	EC001439
ETIM 10.0	EC001439	ECLASS 14.0	27-37-16-05
ECLASS 15.0	27-37-16-05		

ITS 24-240VUC M7C PU10

Weidmüller Interface GmbH & Co. KG
 Klingenbergstraße 26
 D-32758 Detmold
 Germany

www.weidmueller.com

Drawings

Wiring diagram

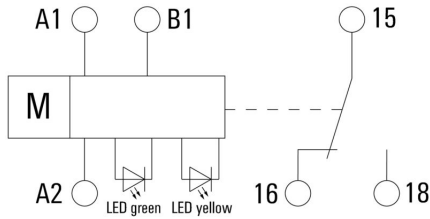

Dimensional drawing

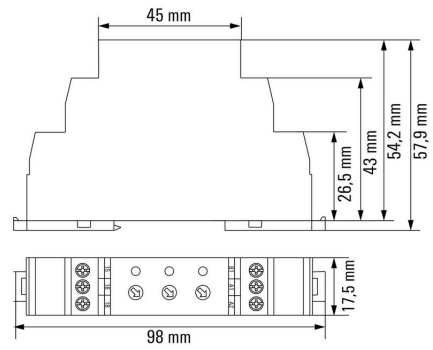

Miscellaneous

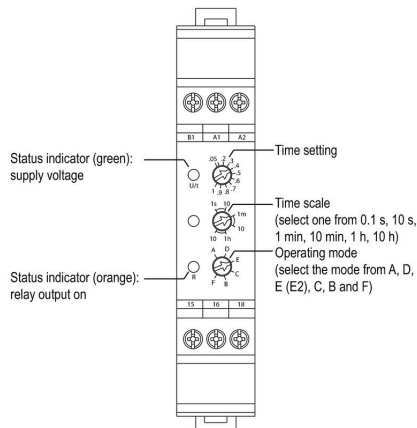

Detailed drawing

Graph

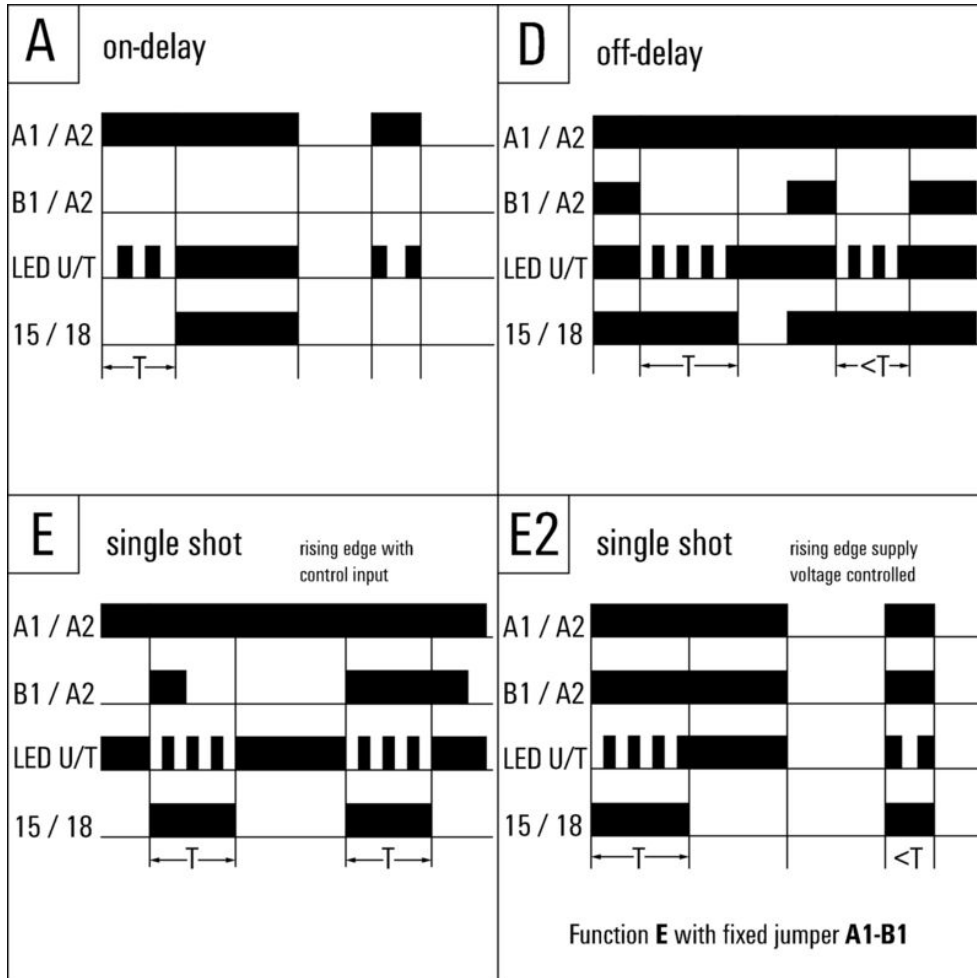

Time functions

Graph

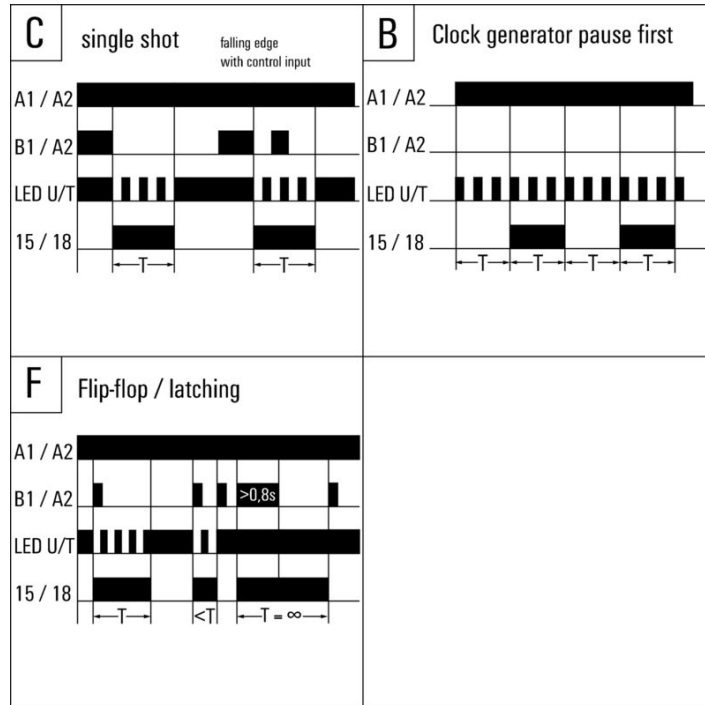

Time functions

Type codes

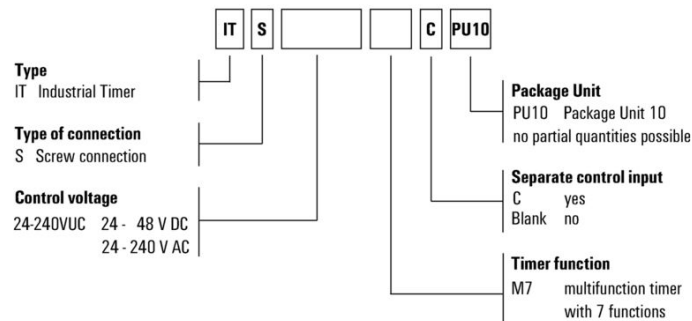

This product is the same as order no. 2496190000 - ITS 24-240VUC 1C0 M7C (package unit 1 piece) but in a package unit of 10 pieces and a minimum order quantity of 500 pieces.

Miscellaneous

ITS 24-240VUC M7C PU10

Weidmüller Interface GmbH & Co. KG
 Klingenbergstraße 26
 D-32758 Detmold
 Germany

www.weidmueller.com

Accessories

Crosshead screwdriver Phillips



Crosshead screwdriver, Phillips, SDK PH DIN 5262, ISO 8764/2-PH, output to ISO 8764-PH, ChromTop tip, SoftFinish grip

General ordering data

Type	SDK PH1 X 80	Version	
Order No.	2749410000	Screwdriver, Blade width (B): 4.5 mm, 80 mm, Blade thickness (A): 1	
GTIN (EAN)	4050118895636		
Qty.	1 ST		

Type	SDIK PH1 X 80	Version	
Order No.	2749890000	Screwdriver, Blade width (B): 1 mm, 80 mm, Blade thickness (A): 1	
GTIN (EAN)	4050118897098		
Qty.	1 ST		

Crosshead screwdriver, Phillips



VDE insulated screwdriver sets, for working on live parts up to 1000 V AC and 1500 V DC, DIN EN 60900. IEC 900. Each piece is "GS" safety tested. Blade made from fully hardened, high-alloy chromium-vanadium-molybdenum steel, gun-metal finish.

General ordering data

Type	SDIK SLIM PH1 X 80	Version	
Order No.	2749650000	Screwdriver, Blade width (B): 1 mm, 80 mm, Blade thickness (A): 1	
GTIN (EAN)	4050118896398		
Qty.	1 ST		

ITS 24-240VUC M7C PU10

Weidmüller Interface GmbH & Co. KG
 Klingenbergstraße 26
 D-32758 Detmold
 Germany

www.weidmueller.com

Accessories

Blank



ESG is the tried-and-tested marker in MultiCard format for use on many well-known electrical devices. The result is high-quality device marking with a high-contrast appearance.

Various types are available for devices from manufacturers like Siemens, ABB, Beckhoff etc.

Advantages at a glance:

- Tags for universal usage, self-adhesive or clip-on tags, depending on type
- For aligned equipment, e.g. circuit breakers, we supply ESG markers for clipping onto tag rails
- Individual laser-quality printing according to specifications

For custom printing: Please send us a file of our labeling software M-Print PRO or M-Print PRO Online (without installation) for your labeling specifications.

General ordering data

Type	ESG 6/15 K MC NE GE	Version
Order No.	1880130000	ESG, Device markers x 15 mm, PA 66, Colour: yellow, Self-adhesive
GTIN (EAN)	4032248478910	
Qty.	200 ST	
Type	ESG 6/15 K MC NE WS	Version
Order No.	1880100000	ESG, Device markers x 15 mm, PA 66, Colour: white, Self-adhesive
GTIN (EAN)	4032248478781	
Qty.	200 ST	
Type	ESG 6/17 K MC NE GE	Version
Order No.	1880110000	ESG, Device markers x 17 mm, PA 66, Colour: yellow, Self-adhesive
GTIN (EAN)	4032248478798	
Qty.	200 ST	
Type	ESG 6/17 K MC NE WS	Version
Order No.	1880120000	ESG, Device markers x 17 mm, PA 66, Colour: white, Self-adhesive
GTIN (EAN)	4032248478804	
Qty.	200 ST	

ESG 6/15



Guaranteed long service life: ESG

The multi-colour and multi-format labels have a strong adhesive layer to ensure the best possible adhesion to the underlying surface. Double laminated polyester makes the basic material very thin and yet extremely tear-resistant.

Your benefits with MultiMark

- "Different materials for various requirements"
- Can be used with equipment from many manufacturers
- Device markers with a familiar design

General ordering data

Type	ESG 6/15 MM WS	Version
Order No.	2619940000	ESG, Device markers, 6 x 15 mm, white
GTIN (EAN)	4050118626148	
Qty.	3000 ST	

ITS 24-240VUC M7C PU10

Weidmüller Interface GmbH & Co. KG
Klingenbergstraße 26
D-32758 Detmold
Germany

Accessories

www.weidmueller.com

ESG 6/17



Guaranteed long service life: ESG

The multi-colour and multi-format labels have a strong adhesive layer to ensure the best possible adhesion to the underlying surface. Double laminated polyester makes the basic material very thin and yet extremely tear-resistant.

Your benefits with MultiMark

- “Different materials for various requirements”
- Can be used with equipment from many manufacturers
- Device markers with a familiar design

General ordering data

Type	ESG 6/17 MM WS	Version	
Order No.	2005100000	ESG, Device markers, 6 x 17 mm, white	
GTIN (EAN)	4050118390728		
Qty.	3000 ST		