

BLF 3.50/14/180LH SN BK BX

Weidmüller Interface GmbH & Co. KG

Klingenbergstraße 26

D-32758 Detmold

Germany

www.weidmueller.com

Product image

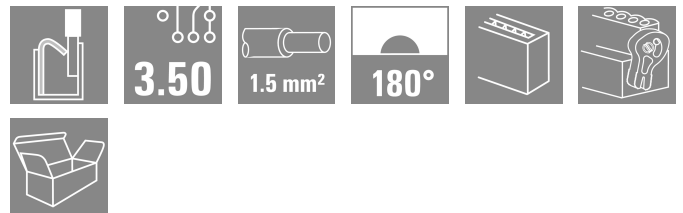

Connect efficiently - in a small space: female header with spring connection (PUSH IN) as a plug-in connection level; used together with male headers in 3.50 mm pitch.

General ordering data

Version	PCB plug-in connector, female plug, 3.50 mm, Number of poles: 14, 180°, PUSH IN with actuator, Clamping range, max. : 1.5 mm², Box
Order No.	2538130000
Type	BLF 3.50/14/180LH SN BK BX
GTIN (EAN)	4050118549850
Qty.	30 items
Product data	IEC: 320 V / 17.5 A / 0.14 - 1.5 mm² UL: 300 V / 10 A / AWG 26 - AWG 16
Packaging	Box
Delivery status	This article will no longer be available in the future.
Last order date	2026-10-31T00:00:00+01:00

Creation date 04.05.2026 01:44:35 MEZ

Catalogue status / Drawings

BLF 3.50/14/180LH SN BK BX

Weidmüller Interface GmbH & Co. KG
Klingenbergstraße 26
D-32758 Detmold
Germany

www.weidmueller.com

Technical data

Approvals

Approvals



ROHS	Conform
UL File Number Search	UL Website
Certificate No. (cURus)	E60693

Dimensions and weights

Depth	30.05 mm	Depth (inches)	1.1831 inch
Height	15.08 mm	Height (inches)	0.5937 inch
Width	55.9 mm	Width (inches)	2.2008 inch
Net weight	14.67 g		

Environmental Product Compliance

RoHS Compliance Status	Compliant without exemption		
REACH SVHC	No SVHC above 0.1 wt%		
Product Carbon Footprint	Cradle to gate	0,342 kg CO2 eq.	

System Parameters

Product family	OMNIMATE Signal - series BL/SL 3.50		
Type of connection	Field connection		
Wire connection method	PUSH IN with actuator		
Pitch in mm (P)	3.50 mm		
Pitch in inches (P)	0.138 "		
Conductor outlet direction	180°		
Number of poles	14		
L1 in mm	45.50 mm		
L1 in inches	1.791 "		
Number of rows	1		
Pin series quantity	1		
Rated cross-section	1.5 mm ²		
Touch-safe protection acc. to DIN VDE 57 106	Safe from finger touch		
Touch-safe protection acc. to DIN VDE 0470	IP20 plugged/ IP10 unplugged		
Protection degree	IP20, when fully mounted		
Volume resistance	≤5 mΩ		
Can be coded	Yes		
Stripping length	8 mm		
Stripping length tolerance	min.	0 mm	
	max.	1 mm	
Screwdriver blade	0.4 x 2.5		
Screwdriver blade standard	DIN 5264-A		
Plugging cycles	25		
Plugging force/pole, max.	6 N		
Pulling force/pole, max.	6 N		

Material data

Insulating material	PA GF	Colour	black
Colour of operational elements	orange	Colour chart (similar)	RAL 9011

BLF 3.50/14/180LH SN BK BX

Weidmüller Interface GmbH & Co. KG
 Klingenbergstraße 26
 D-32758 Detmold
 Germany

www.weidmueller.com

Technical data

Insulating material group	II	Comparative Tracking Index (CTI)	≥ 400, ≤ 600
Moisture Level (MSL)		UL 94 flammability rating	V-0
Contact material	Cu-alloy	Contact surface	tinned
Storage temperature, min.	-40 °C	Storage temperature, max.	70 °C
Operating temperature, min.	-50 °C	Operating temperature, max.	120 °C
Temperature range, installation, min.	-30 °C	Temperature range, installation, max.	100 °C

Conductors suitable for connection

Clamping range, min.	0.14 mm ²
Clamping range, max.	1.5 mm ²
Wire connection cross section AWG, min.	AWG 26
Wire connection cross section AWG, max.	AWG 16
Solid, min. H05(07) V-U	0.14 mm ²
Solid, max. H05(07) V-U	1.5 mm ²
Flexible, min. H05(07) V-K	0.14 mm ²
Flexible, max. H05(07) V-K	1.5 mm ²
w. plastic collar ferrule, DIN 46228 pt 4, min.	0.28 mm ²
w. plastic collar ferrule, DIN 46228 pt 4, max.	1 mm ²
w. wire end ferrule, DIN 46228 pt 1, min.	0.25 mm ²
w. wire end ferrule, DIN 46228 pt 1, max.	1 mm ²
Plug gauge in accordance with EN 60999 a x b; ø	2.4 mm x 1.5 mm

Clampable conductor	Cross-section for conductor connection	Type	fine-wired
		nominal	0.25 mm ²
wire end ferrule		Stripping length	nominal 10 mm
		Recommended wire-end ferrule	H0.25/12 HBL
Cross-section for conductor connection		Type	fine-wired
		nominal	0.34 mm ²
wire end ferrule		Stripping length	nominal 10 mm
		Recommended wire-end ferrule	H0.34/12 TK
Cross-section for conductor connection		Type	fine-wired
		nominal	0.5 mm ²
wire end ferrule		Stripping length	nominal 10 mm
		Recommended wire-end ferrule	H0.5/14 OR
Cross-section for conductor connection		Type	fine-wired
		nominal	0.75 mm ²
wire end ferrule		Stripping length	nominal 10 mm
		Recommended wire-end ferrule	H0.75/14T HBL
Cross-section for conductor connection		Type	fine-wired
		nominal	1 mm ²
wire end ferrule		Stripping length	nominal 10 mm
		Recommended wire-end ferrule	H1.0/14 GE

Reference text: The outside diameter of the plastic collar should not be larger than the pitch (P). Length of ferrules is to be chosen depending on the product and the rated voltage.

BLF 3.50/14/180LH SN BK BX

Weidmüller Interface GmbH & Co. KG
 Klingenbergstraße 26
 D-32758 Detmold
 Germany

www.weidmueller.com

Technical data

Rated data acc. to IEC

tested acc. to standard	IEC 60664-1, IEC 61984	Rated current, min. number of poles (Tu=20°C)	17.5 A
Rated current, max. number of poles (Tu=20°C)	14.7 A	Rated current, min. number of poles (Tu=40°C)	17.1 A
Rated current, max. number of poles (Tu=40°C)	13.1 A	Rated voltage for surge voltage class / pollution degree II/2	320 V
Rated voltage for surge voltage class / pollution degree III/2	160 V	Rated voltage for surge voltage class / pollution degree III/3	160 V
Rated impulse voltage for surge voltage class/ pollution degree II/2	2.5 kV	Rated impulse voltage for surge voltage class/ pollution degree III/2	2.5 kV
Rated impulse voltage for surge voltage class/ contamination degree III/3	2.5 kV	Short-time withstand current resistance	1 x 1s with 120 A

Rated data acc. to CSA

Rated voltage (Use group B / CSA)	300 V	Rated voltage (Use group C / CSA)	50 V
Rated voltage (Use group D / CSA)	300 V	Rated current (Use group B / CSA)	10 A
Rated current (Use group D / CSA)	10 A	Wire cross-section, AWG, min.	AWG 16
Wire cross-section, AWG, max.	AWG 26		

Rated data acc. to UL 1059

Institute (cURus)	CURUS	Certificate No. (cURus)	E60693
Rated voltage (Use group B / UL 1059)	300 V	Rated voltage (Use group C / UL 1059)	50 V
Rated voltage (Use group D / UL 1059)	300 V	Rated current (Use group B / UL 1059)	10 A
Rated current (Use group D / UL 1059)	10 A	Wire cross-section, AWG, min.	AWG 26
Wire cross-section, AWG, max.	AWG 16	Reference to approval values	Specifications are maximum values, details - see approval certificate.

Packing

Packaging	Box	VPE length	338.00 mm
VPE width	130.00 mm	VPE height	33.00 mm

Type tests

Visual and dimensional test	Standard	IEC 605 12-1-1:2002-02
	Test	dimensional inspection
	Evaluation	passed
	Standard	IEC 605 12-1-2:2002-02
	Test	weight check
	Evaluation	passed
Test: Durability of markings	Standard	IEC 61984:2001-10 section 6.2
	Test	visual examination
	Evaluation	passed
	Standard	IEC 60068-2-70:1995-12 test Xb
	Test	mark of origin, type identification, pitch, type of material, date clock, approval marking UL, approval marking CSA
	Evaluation	available
Test: Misengagement (Non-interchangeability)	Test	durability
	Evaluation	passed
	Standard	IEC 605 12-13-5:2006-02
	Test	180° turned with coding elements, 180° turned without coding elements
	Evaluation	passed

BLF 3.50/14/180LH SN BK BX

Weidmüller Interface GmbH & Co. KG
 Klingenbergstraße 26
 D-32758 Detmold
 Germany

www.weidmueller.com

Technical data

	Test	durability	
Test: Clampable cross section	Evaluation	passed	
	Standard	IEC 60999-1:1999-11 section 9.1, IEC 60947-1:2011-03 section 8.2.4.5.1	
	Conductor type	Type of conductor and conductor cross-section	solid 0.14 mm ²
		Type of conductor and conductor cross-section	stranded 0.14 mm ²
		Type of conductor and conductor cross-section	solid 1.5 mm ²
		Type of conductor and conductor cross-section	stranded 1.5 mm ²
		Type of conductor and conductor cross-section	AWG 26/1
		Type of conductor and conductor cross-section	AWG 26/19
		Type of conductor and conductor cross-section	AWG 16/1
		Type of conductor and conductor cross-section	AWG 16/19
Evaluation	passed		
Test for damage to and accidental loosening of conductors	Standard	IEC 60999-1:1999-11 section 9.4 bzw. section 8.10	
	Requirement	0.2 kg	
	Conductor type	Type of conductor and conductor cross-section	AWG 26/1
		Type of conductor and conductor cross-section	AWG 26/19
	Evaluation	passed	
	Requirement	0.3 kg	
	Conductor type	Type of conductor and conductor cross-section	H05V-U0.5
		Type of conductor and conductor cross-section	H05V-K0.5
	Evaluation	passed	
	Requirement	0.4 kg	
Conductor type	Type of conductor and conductor cross-section	H07V-U1.5	
	Type of conductor and conductor cross-section	H07V-K1.5	
	Type of conductor and conductor cross-section	AWG 16/1	
	Type of conductor and conductor cross-section	AWG 16/19	
Evaluation	passed		
Pull-out test	Standard	IEC 60999-1:1999-11 section 9.5	
	Requirement	≥10 N	

BLF 3.50/14/180LH SN BK BX

Weidmüller Interface GmbH & Co. KG
 Klingenbergstraße 26
 D-32758 Detmold
 Germany

Technical data

www.weidmueller.com

Conductor type	Type of conductor and conductor cross-section	AWG 26/1
	Type of conductor and conductor cross-section	AWG 26/19
Evaluation	passed	
Requirement	≥20 N	
Conductor type	Type of conductor and conductor cross-section	H05V-U0.5
	Type of conductor and conductor cross-section	H05V-K0.5
Evaluation	passed	
Requirement	≥40 N	
Conductor type	Type of conductor and conductor cross-section	H07V-U1.5
	Type of conductor and conductor cross-section	H07V-K1.5
	Type of conductor and conductor cross-section	AWG 16/1
	Type of conductor and conductor cross-section	AWG 16/19
Evaluation	passed	

Important note

IPC conformity Conformity: The products are developed, manufactured and delivered according international recognized standards and norms and comply with the assured properties in the data sheet resp. fulfill decorative properties in accordance with IPC-A-6 10 "Class 2". Further claims on the products can be evaluated on request.

- Notes
- Additional variants on request
 - Gold-plated contact surfaces on request
 - Rated current related to rated cross-section & min. No. of poles.
 - Wire end ferrule without plastic collar to DIN 46228/1
 - Wire end ferrule with plastic collar to DIN 46228/4
 - P on drawing = pitch
 - Rated data refer only to the component itself. Clearance and creepage distances to other components are to be designed in accordance with the relevant application standards.
 - In accordance with IEC 61984, OMNIMATE-connectors are connectors without breaking capacity (COC). During designated use, connectors are not allowed to be engaged or disengaged when live or under load
 - Long term storage of the product with average temperature of 50 °C and maximum humidity 70%, 36 months

Classifications

ETIM 8.0	EC002638	ETIM 9.0	EC002638
ETIM 10.0	EC002638	ECLASS 14.0	27-46-02-02
ECLASS 15.0	27-46-02-02		

BLF 3.50/14/180LH SN BK BX

Weidmüller Interface GmbH & Co. KG
 Klingenbergstraße 26
 D-32758 Detmold
 Germany

www.weidmueller.com

Drawings

Product image

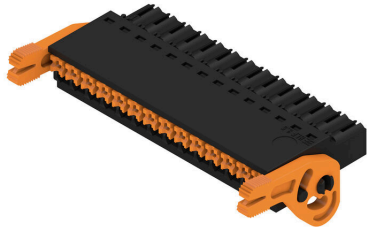

Dimensional drawing

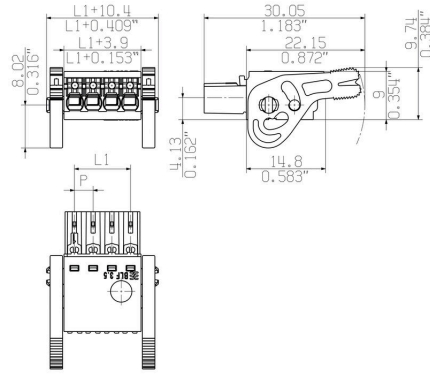

Derating curve

BLF 3.50/./180 - SL-SMT 3.50/./180

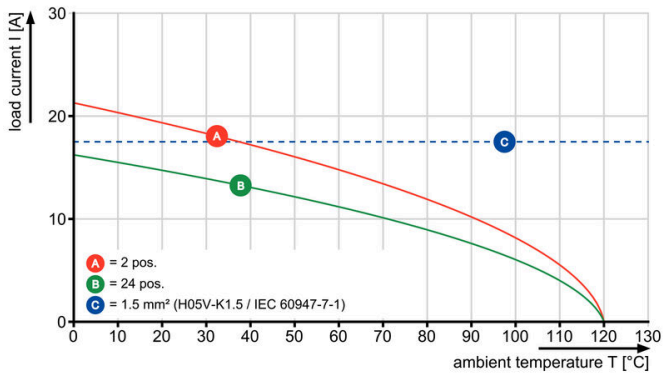

Derating curve

BLF 3.50/./180 - SL-SMT 3.50/./180

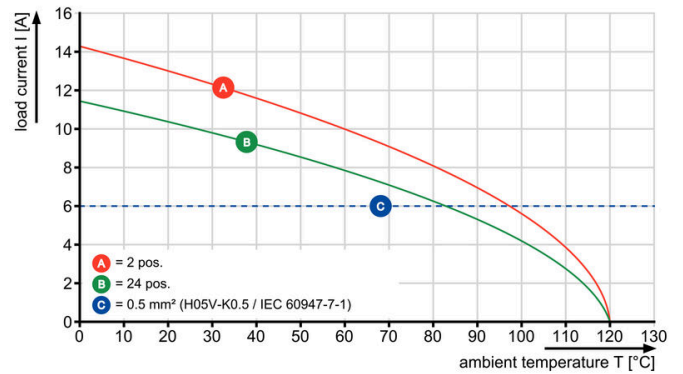

Product benefits

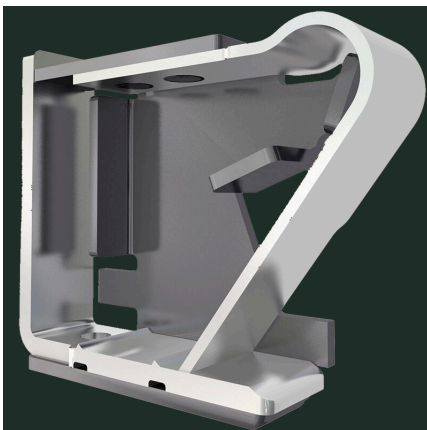

Solid PUSH IN contactSafe and durable

BLF 3.50/14/180LH SN BK BX

Weidmüller Interface GmbH & Co. KG
 Klingenbergstraße 26
 D-32758 Detmold
 Germany

Counterpart

www.weidmueller.com

SL 3.50/135F

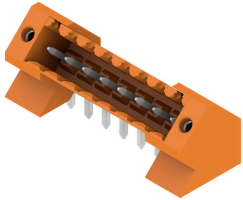

- Pin headers for wave soldering in 3.50 mm pitch
- Plugging direction is parallel (90°), straight 180° or angled (135°) to the PCB
 - Housing variant: screw flange (F)
 - Packed in a cardboard box (BX)
 - Pin header can be coded

General ordering data

Type	SL 3.50/14/135F 3.2SN O...	Version
Order No.	1643450000	PCB plug-in connector, male header, Flange, THT solder connection,
GTIN (EAN)	4008190282219	3.50 mm, Number of poles: 14, 135°, Solder pin length (l): 3.2 mm,
Qty.	30 ST	tinned, orange, Box

SL 3.50/180F

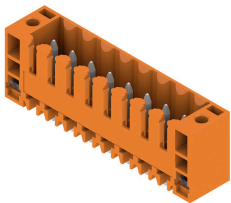

- Pin headers for wave soldering in 3.50 mm pitch
- Plugging direction is parallel (90°), straight 180° or angled (135°) to the PCB
 - Housing variant: screw flange (F)
 - Packed in a cardboard box (BX)
 - Pin header can be coded

General ordering data

Type	SL 3.50/14/180F 3.2SN O...	Version
Order No.	1607620000	PCB plug-in connector, male header, Flange, THT solder connection,
GTIN (EAN)	4008190055196	3.50 mm, Number of poles: 14, 180°, Solder pin length (l): 3.2 mm,
Qty.	50 ST	tinned, orange, Box

SL 3.50/90F

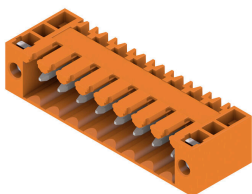

- Pin headers for wave soldering in 3.50 mm pitch
- Plugging direction is parallel (90°), straight 180° or angled (135°) to the PCB
 - Housing variant: screw flange (F)
 - Packed in a cardboard box (BX)
 - Pin header can be coded

General ordering data

Type	SL 3.50/14/90F 3.2SN OR...	Version
Order No.	1607160000	PCB plug-in connector, male header, Flange, THT solder connection,
GTIN (EAN)	4008190003340	3.50 mm, Number of poles: 14, 90°, Solder pin length (l): 3.2 mm,
Qty.	50 ST	tinned, orange, Box

BLF 3.50/14/180LH SN BK BX

Weidmüller Interface GmbH & Co. KG
 Klingenbergstraße 26
 D-32758 Detmold
 Germany

Counterpart

www.weidmueller.com

SLD 3.50/90F

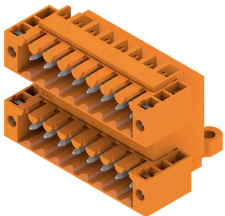

Two-tier pin header for wave soldering in 3.50 mm pitch. The connector is available in open, closed and flange versions. The male connectors provide space for labelling and can be coded. Packed in a cardboard box.

General ordering data

Type	SLD 3.50/28/90F 3.2SN O...	Version
Order No.	1633930000	PCB plug-in connector, male header, Flange, THT solder connection,
GTIN (EAN)	4008190258382	3.50 mm, Number of poles: 28, 90°, Solder pin length (l): 3.2 mm,
Qty.	20 ST	tinned, orange, Box

SLD 3.50V/180F

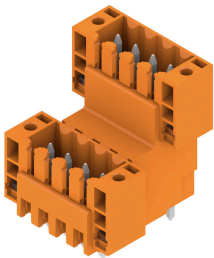

Double-level, staggered pin header for wave soldering at 3.50 mm pitch. They are available in closed and flanged versions. The male connectors provide space for labelling and can be coded.

General ordering data

Type	SLD 3.50 V/28/180F 3.2 ...	Version
Order No.	1641300000	PCB plug-in connector, male header, Flange, THT solder connection,
GTIN (EAN)	4008190279707	3.50 mm, Number of poles: 28, 180°, Solder pin length (l): 3.2 mm,
Qty.	10 ST	tinned, orange, Box

SLD 3.50V/90F

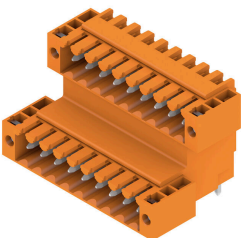

Double-level, staggered pin header for wave soldering at 3.50 mm pitch. They are available in closed and flanged versions. The male connectors provide space for labelling and can be coded.

General ordering data

Type	SLD 3.50 V/28/90F 3.2 S...	Version
Order No.	1642430000	PCB plug-in connector, male header, Flange, THT solder connection,
GTIN (EAN)	4008190280956	3.50 mm, Number of poles: 28, 90°, Solder pin length (l): 3.2 mm,
Qty.	10 ST	tinned, orange, Box

BLF 3.50/14/180LH SN BK BX

Weidmüller Interface GmbH & Co. KG
 Klingenbergstraße 26
 D-32758 Detmold
 Germany

www.weidmueller.com

Counterpart

SL-SMT 3.5/180F Box



- High-temperature-resistant male header, 3.50 mm pitch.
- Plugging direction parallel (90°), straight 180° or angled (135°) to PCB
 - Housing variants: closed side (G), screw flange (F), solder flange (LF) or snap-on solder flange (RF)
 - Optimised for the SMT process
 - Pin length 3.2 mm universal for all soldering methods
 - Pin length 1.5 mm optimised for reflow soldering methods
 - Packed either in a box (BX) or tape-on-reel (RL)
 - Male header can be coded

General ordering data

Type	SL-SMT 3.50/14/180F 3.2...	Version
Order No.	1842890000	PCB plug-in connector, male header, Flange, THT/THR solder
GTIN (EAN)	4032248354351	connection, 3.50 mm, Number of poles: 14, 180°, Solder pin length
Qty.	30 ST	(l): 3.2 mm, tinned, black, Box

SL-SMT 3.5/180LF Box

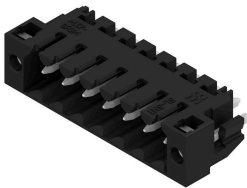

- High-temperature-resistant male header, 3.50 mm pitch.
- Plugging direction parallel (90°), straight 180° or angled (135°) to PCB
 - Housing variants: closed side (G), screw flange (F), solder flange (LF) or snap-on solder flange (RF)
 - Optimised for the SMT process
 - Pin length 3.2 mm universal for all soldering methods
 - Pin length 1.5 mm optimised for reflow soldering methods
 - Packed either in a box (BX) or tape-on-reel (RL)
 - Male header can be coded

General ordering data

Type	SL-SMT 3.50/14/180LF 3....	Version
Order No.	1842660000	PCB plug-in connector, male header, Solder flange, THT/THR solder
GTIN (EAN)	4032248354023	connection, 3.50 mm, Number of poles: 14, 180°, Solder pin length
Qty.	30 ST	(l): 3.2 mm, tinned, black, Box

SL-SMT 3.5/180RF

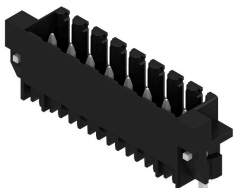

- High-temperature-resistant male header, 3.50 mm pitch.
- Plugging direction parallel (90°), straight 180° or angled (135°) to PCB
 - Housing variants: closed side (G), screw flange (F), solder flange (LF) or snap-on solder flange (RF)
 - Optimised for the SMT process
 - Pin length 3.2 mm universal for all soldering methods
 - Pin length 1.5 mm optimised for reflow soldering methods
 - Packed either in a box (BX) or tape-on-reel (RL)
 - Male header can be coded

BLF 3.50/14/180LH SN BK BX

Weidmüller Interface GmbH & Co. KG
 Klingenbergstraße 26
 D-32758 Detmold
 Germany

Counterpart

www.weidmueller.com

General ordering data

Type	SL-SMT 3.50/14/180RF 1...	Version
Order No.	1291430000	PCB plug-in connector, male header, Clip-on flange, THT/THR solder connection, 3.50 mm, Number of poles: 14, 180°, Solder pin length (l): 1.5 mm, tinned, black, Box
GTIN (EAN)	4050118084764	
Qty.	50 ST	

SL-SMT 3.5/90F Box

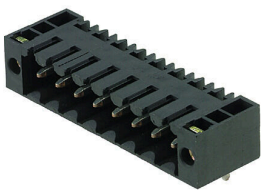

- High-temperature-resistant male header, 3.50 mm pitch.
- Plugging direction parallel (90°), straight 180° or angled (135°) to PCB
 - Housing variants: closed side (G), screw flange (F), solder flange (LF) or snap-on solder flange (RF)
 - Optimised for the SMT process
 - Pin length 3.2 mm universal for all soldering methods
 - Pin length 1.5 mm optimised for reflow soldering methods
 - Packed either in a box (BX) or tape-on-reel (RL)
 - Male header can be coded

General ordering data

Type	SL-SMT 3.50/14/90F 3.2S...	Version
Order No.	1842200000	PCB plug-in connector, male header, Flange, THT/THR solder connection, 3.50 mm, Number of poles: 14, 90°, Solder pin length (l): 3.2 mm, tinned, black, Box
GTIN (EAN)	4032248353552	
Qty.	30 ST	

SL-SMT 3.5/90LF Box

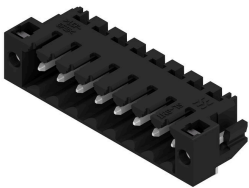

- High-temperature-resistant male header, 3.50 mm pitch.
- Plugging direction parallel (90°), straight 180° or angled (135°) to PCB
 - Housing variants: closed side (G), screw flange (F), solder flange (LF) or snap-on solder flange (RF)
 - Optimised for the SMT process
 - Pin length 3.2 mm universal for all soldering methods
 - Pin length 1.5 mm optimised for reflow soldering methods
 - Packed either in a box (BX) or tape-on-reel (RL)
 - Male header can be coded

General ordering data

Type	SL-SMT 3.50/14/90LF 3.2...	Version
Order No.	1841970000	PCB plug-in connector, male header, Solder flange, THT/THR solder connection, 3.50 mm, Number of poles: 14, 90°, Solder pin length (l): 3.2 mm, tinned, black, Box
GTIN (EAN)	4032248353323	
Qty.	30 ST	

BLF 3.50/14/180LH SN BK BX

Weidmüller Interface GmbH & Co. KG
 Klingenbergstraße 26
 D-32758 Detmold
 Germany

www.weidmueller.com

Counterpart

SL-SMT 3.5/90RF

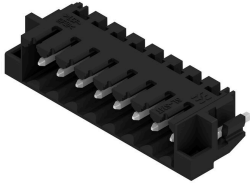

- High-temperature-resistant male header, 3.50 mm pitch.
- Plugging direction parallel (90°), straight 180° or angled (135°) to PCB
 - Housing variants: closed side (G), screw flange (F), solder flange (LF) or snap-on solder flange (RF)
 - Optimised for the SMT process
 - Pin length 3.2 mm universal for all soldering methods
 - Pin length 1.5 mm optimised for reflow soldering methods
 - Packed either in a box (BX) or tape-on-reel (RL)
 - Male header can be coded

General ordering data

Type	SL-SMT 3.50/14/90RF 1.5...	Version
Order No.	1000690000	PCB plug-in connector, male header, Clip-on flange, THT/THR solder
GTIN (EAN)	4032248822201	connection, 3.50 mm, Number of poles: 14, 90°, Solder pin length (l):
Qty.	50 ST	1.5 mm, tinned, black, Box

SL-THR 3.5/135F



- High-temperature-resistant male header, 3.50 mm pitch.
- Plugging direction parallel (90°), straight 180° or angled (135°) to PCB
 - Housing variants: closed side (G), screw flange (F), solder flange (LF) or snap-on solder flange (RF)
 - Optimised for the SMT process
 - Pin length 3.2 mm universal for all soldering methods
 - Pin length 1.5 mm optimised for reflow soldering methods
 - Packed either in a box (BX) or tape-on-reel (RL)
 - Male header can be coded

General ordering data

Type	SL-SMT 3.50/14/135F 3.2...	Version
Order No.	1003640000	PCB plug-in connector, male header, Flange, THT/THR solder
GTIN (EAN)	4032248700264	connection, 3.50 mm, Number of poles: 14, 135°, Solder pin length
Qty.	30 ST	(l): 3.2 mm, tinned, black, Box