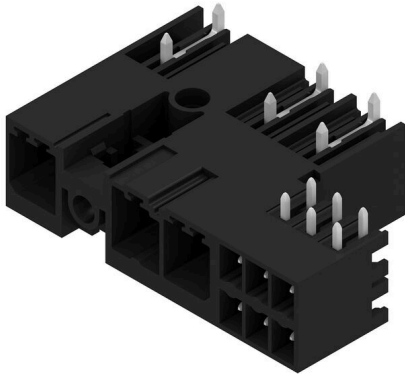

SV-SMT 7.62HP/03/270MF2 SC/6 2.6SN BX

Weidmüller Interface GmbH & Co. KG
 Klingenbergstraße 26
 D-32758 Detmold
 Germany

www.weidmueller.com

Product image

OMNIMATE Power BV / SV 7.62HP Hybrid – for power, signals and EMC

Three functions in one!

The OMNIMATE Power Hybrid connector provides developers and users with the perfect three-in-one solution.

This hybrid motor connector simultaneously unites power, signals and pluggable EMC shield support. Thus you save space on the PCB, on the outer side of the housing, and in the electrical cabinet. The self-snapping one-handed interlock mechanism requires only one plugging step and thus speeds up installation and maintenance procedures. It is easy to handle and interlocks automatically – even in difficult installation positions. The unique shielding shape and slender 30° wire entry enable a space savings of up to 10 cm between rows.

General ordering data

Version	PCB plug-in connector, male header, closed side, Middle flange, THT/THR solder connection, 7.62 mm, Number of poles: 3, 270°, Solder pin length (l): 2.6 mm, tinned, black, Box
Order No.	2529400000
Type	SV-SMT 7.62HP/03/270MF2 SC/6 2.6SN BX
GTIN (EAN)	4050118539578
Qty.	42 items
Product data	IEC: 1000 V / 41 A UL: 300 V / 33 A
Packaging	Box

SV-SMT 7.62HP/03/270MF2 SC/6 2.6SN BX

Weidmüller Interface GmbH & Co. KG
Klingenbergstraße 26
D-32758 Detmold
Germany

www.weidmueller.com

Technical data

Approvals

Approvals



ROHS	Conform
UL File Number Search	UL Website
Certificate No. (cURus)	E60693

Dimensions and weights

Depth	28.3 mm	Depth (inches)	1.1142 inch
Height	14 mm	Height (inches)	0.5512 inch
Height of lowest version	11.4 mm	Width	42.88 mm
Width (inches)	1.6882 inch	Net weight	10.4 g

Environmental Product Compliance

RoHS Compliance Status	Compliant without exemption
REACH SVHC	No SVHC above 0.1 wt%

System specifications

Product family	OMNIMATE Power - series BV/SV 7.62HP	Type of connection	Board connection
Mounting onto the PCB	THT/THR solder connection	Pitch in mm (P)	7.62 mm
Pitch in inches (P)	0.300 "	Outgoing elbow	270°
Number of poles	3	Number of solder pins per pole	2
Solder pin length (l)	2.6 mm	Solder pin dimensions	0.8 x 1.0 mm
Solder eyelet hole diameter (D)	1.4 mm	Solder eyelet hole diameter tolerance (D)+	0,1 mm
L1 in mm	22.86 mm	L1 in inches	0.900 "
L2 in mm	7.62 mm	L2 in inch	0.300 "
Number of rows	1	Pin series quantity	1
Touch-safe protection acc. to DIN VDE 57 106	safe to back of hand above the printed circuit board	Touch-safe protection acc. to DIN VDE 0470	IP 20
Volume resistance	2.00 mΩ	Can be coded	Yes
Plugging force/pole, max.	12 N	Pulling force/pole, max.	7 N

Material data

Insulating material	PA 9T	Colour	black
Colour chart (similar)	RAL 9011	Insulating material group	I
Comparative Tracking Index (CTI)	≥ 600	Moisture Level (MSL)	1
UL 94 flammability rating	V-0	Contact material	Cu-alloy
Contact surface	tinned	Layer structure of solder connection	1...3 μm Ni / 4...6 μm Sn matt
Layer structure of plug contact	1...3 μm Ni / 4...6 μm Sn matt	Storage temperature, min.	-40 °C
Storage temperature, max.	70 °C	Operating temperature, min.	-50 °C
Operating temperature, max.	130 °C	Temperature range, installation, min.	-25 °C
Temperature range, installation, max.	130 °C		

SV-SMT 7.62HP/03/270MF2 SC/6 2.6SN BX

Weidmüller Interface GmbH & Co. KG
 Klingenbergstraße 26
 D-32758 Detmold
 Germany

www.weidmueller.com

Technical data

Rated data acc. to IEC

tested acc. to standard	IEC 60664-1, IEC 61984	Rated current, min. number of poles (Tu=20°C)	41 A
Rated current, max. number of poles (Tu=20°C)	41 A	Rated current, min. number of poles (Tu=40°C)	41 A
Rated current, max. number of poles (Tu=40°C)	41 A	Rated voltage for surge voltage class / pollution degree II/2	1000 V
Rated voltage for surge voltage class / pollution degree III/2	630 V	Rated voltage for surge voltage class / pollution degree III/3	630 V
Rated impulse voltage for surge voltage class/ pollution degree II/2	6 kV	Rated impulse voltage for surge voltage class/ pollution degree III/2	6 kV
Rated impulse voltage for surge voltage class/ contamination degree III/3	6 kV	Short-time withstand current resistance	3 x 1s with 420 A

Rated data acc. to UL 1059

Institute (cURus)	CURUS	Certificate No. (cURus)	E60693
Rated voltage (Use group B / UL 1059)	300 V	Rated voltage (Use group C / UL 1059)	300 V
Rated voltage (Use group D / UL 1059)	600 V	Rated current (Use group B / UL 1059)	33 A
Rated current (Use group C / UL 1059)	33 A	Rated current (Use group D / UL 1059)	5 A
Creepage distance, min.	9.6 mm	Clearance distance, min.	6.9 mm
Reference to approval values	Specifications are maximum values, details - see approval certificate.		

Packing

Packaging	Box	VPE length	338.00 mm
VPE width	130.00 mm	VPE height	33.00 mm

Technical data - hybrid

Pitch in mm (hybrid)	nominal	3.81 mm	
	Hybrid component	Signal	
Pitch in mm (Signal)	3.81 mm		
Pitch in inch (hybrid)	nominal	0.15 "	
	Hybrid component	Signal	
Pitch in inches (Signal)	0.15 "		
Pole count (hybrid)	nominal	6	
	Hybrid component	Signal	
Number of poles (Signal)	6		
Number of solder pins per pole (hybrid)	Hybrid component	Signal	
	nominal	1	
Number of solder pins per pole (Signal)	1		
Solder pin dimensions (hybrid)	Solder pin dimensions	0.8 x 0.8 mm	
	Hybrid component	Signal	
Solder pin dimensions (Signal)	0.8 x 0.8 mm		
Solder pin dimensions = d tolerance (hybrid)	Solder pin dimensions = d tolerance	Lower tolerance with prefix (reveals minimum)	-0,03
		Upper tolerance with prefix (reveals maximum)	+0,01
		Tolerance, unit	mm
	Hybrid component	Signal	
Solder pin dimensions = d tolerance (Signal)	-0,03 / +0,01 mm		
Diameter of solder eyelet (hybrid)	Hybrid component	Signal	
	nominal	1.3 mm	

SV-SMT 7.62HP/03/270MF2 SC/6 2.6SN BX

Weidmüller Interface GmbH & Co. KG

Klingenbergstraße 26

D-32758 Detmold

Germany

www.weidmueller.com

Technical data

PCB hole diameter (Signal)	1.3 mm		
Tolerance of the diameter of the solder eyelet (hybrid)	Hybrid component	Signal	
	Solder eyelet hole diameter tolerance (D)	± 0.1 mm	
	Solder eyelet hole diameter tolerance (D)	+ 0,1 mm	
PCB hole diameter tolerance (Signal)	± 0.1 mm		
L2 in mm	7.62 mm		
L2 in inch	0.300 "		
Number of rows (hybrid)	Hybrid component	Signal	
Number of rows (Signal)	2		
Contact material (hybrid)	Hybrid component	Signal	
	Contact material	CuMg	
Contact material (Signal)	CuMg		
Contact surface (hybrid)	Hybrid component	Signal	
	Contact surface	tinned	
Contact surface (Signal)	tinned		
Layer structure of the solder connection (hybrid)	Layer structure of the solder connection	Material	Ni
		Layer strength	min. 1 µm
			max. 3 µm
		Material	Sn
		Layer strength	min. 4 µm
max. 8 µm			
Hybrid component	Signal		
Layer structure of the solder connection (Signal)	1-3 µm Ni / 4-8 µm Sn		
Layer structure of the plug contact (hybrid)	Layer structure of the plug contact	Material	Ni
		Layer strength	min. 1 µm
			max. 3 µm
		Material	Sn
		Layer strength	min. 4 µm
max. 8 µm			
Hybrid component	Signal		
Layer structure of the plug contact (Signal)	1-3 µm Ni / 4-8 µm Sn		
Rated voltage for overvoltage class / pollution severity level II/2 (hybrid)	Hybrid component	Signal	
	nominal	320 V	
Rated voltage for overvoltage class / pollution severity level II/2 (Signal)	320 V		
Rated voltage for overvoltage class / pollution severity level III/2 (hybrid)	Hybrid component	Signal	
	nominal	160 V	
Rated voltage for overvoltage class / pollution severity level III/2 (Signal)	160 V		
Rated voltage for overvoltage class / pollution severity level III/3 (hybrid)	Hybrid component	Signal	
	nominal	160 V	
Rated voltage for overvoltage class / pollution severity level III/3 (Signal)	160 V		
Rated impulse voltage for overvoltage class / pollution severity level II/2 (hybrid)	Hybrid component	Signal	
	nominal	2.5 kV	
Rated impulse voltage for overvoltage class / pollution severity level II/2 (Signal)	2.5 kV		
Rated impulse voltage for overvoltage class / pollution severity level III/2 (hybrid)	Hybrid component	Signal	
	nominal	2.5 kV	
Rated impulse voltage for overvoltage class / pollution severity level III/2 (Signal)	2.5 kV		
Rated impulse voltage for overvoltage class / pollution severity level III/3 (hybrid)	Hybrid component	Signal	
	nominal	2.5 kV	

SV-SMT 7.62HP/03/270MF2 SC/6 2.6SN BX

Weidmüller Interface GmbH & Co. KG
 Klingenbergstraße 26
 D-32758 Detmold
 Germany

www.weidmueller.com

Technical data

Rated impulse voltage for overvoltage class/pollution severity level III/3 (Signal)	2.5 kV	
Short-time withstand current capacity (hybrid)	Short-time withstand current resistance	3 x 1s with 80 A
	Hybrid component	Signal
Short-time withstand current resistance (Signal)	3 x 1s with 80 A	
Creepage distance (hybrid)	Hybrid component	Signal
	min.	4.38 mm
Clearance distance (hybrid)	Hybrid component	Signal
	min.	3.6 mm
Rated voltage (Use group B / CSA) (Hybrid)	Hybrid component	Signal
	nominal	300 V
Rated voltage (Use group B / CSA) (Signal)	300 V	
Rated voltage (Use group C / CSA) (Hybrid)	Hybrid component	Signal
	nominal	50 V
Rated voltage (Use group C / CSA) (Signal)	50 V	
Rated current (Use group B / CSA) (Hybrid)	Hybrid component	Signal
	nominal	9 A
Rated current (Use group B / CSA) (Signal)	9 A	
Rated current (Use group C / CSA) (Hybrid)	Hybrid component	Signal
	nominal	9 A
Rated current (Use group C / CSA) (Signal)	9 A	
Rated current (Use group D / CSA) (Hybrid)	Hybrid component	Signal
	nominal	9 A
Rated current (Use group D / CSA) (Signal)	9 A	
Rated voltage (Use group B / UL 1059) (Hybrid)	Hybrid component	Signal
	nominal	300 V
Rated voltage (Use group B / UL 1059) (Signal)	300 V	
Rated voltage (Use group C / UL 1059) (Hybrid)	Hybrid component	Signal
	nominal	50 V
Rated voltage (Use group C / UL 1059) (Signal)	50 V	
Rated voltage (Use group D / UL 1059) (Hybrid)	Hybrid component	Signal
	nominal	300 V
Rated voltage (Use group D / UL 1059) (Signal)	300 V	
Rated current (Use group B / UL 1059) (Hybrid)	Hybrid component	Signal
	nominal	5 A
Rated current (Use group B / UL 1059) (Signal)	5 A	
Rated current (Use group C / UL 1059) (Hybrid)	Hybrid component	Signal
	nominal	5 A
Rated current (Use group C / UL 1059) (Signal)	5 A	
Rated current (Use group D / UL 1059) (Hybrid)	Hybrid component	Signal

Important note

IPC conformity	Conformity: The products are developed, manufactured and delivered according international recognized standards and norms and comply with the assured properties in the data sheet resp. fulfill decorative properties in accordance with IPC-A-610 "Class 2". Further claims on the products can be evaluated on request.
Notes	<ul style="list-style-type: none"> • Technical specifications refer to the power contacts

SV-SMT 7.62HP/03/270MF2 SC/6 2.6SN BX

Weidmüller Interface GmbH & Co. KG
Klingenbergstraße 26
D-32758 Detmold
Germany

www.weidmueller.com

Technical data

- Technical data of signal contacts: 50V / 5A, stripping length 8mm
- Rated current related to rated cross-section & min. No. of poles.
- Specifications of diagram: P1=7.62 mm; P2=3.81 mm
- Rated data refer only to the component itself. Clearance and creepage distances to other components are to be designed in accordance with the relevant application standards.
- MFX and MSFX: X= Position of the middle flange e.g. MF2, MSF3
- In accordance with IEC 61984, OMNIMATE-connectors are connectors without breaking capacity (COC). During designated use, connectors are not allowed to be engaged or disengaged when live or under load
- Long term storage of the product with average temperature of 50 °C and maximum humidity 70%, 36 months

Classifications

ETIM 8.0	EC002637	ETIM 9.0	EC002637
ETIM 10.0	EC002637	ECLASS 14.0	27-46-03-01
ECLASS 15.0	27-46-03-01		

SV-SMT 7.62HP/03/270MF2 SC/6 2.6SN BX

Weidmüller Interface GmbH & Co. KG
Klingenbergstraße 26
D-32758 Detmold
Germany

Drawings

www.weidmueller.com

Product image

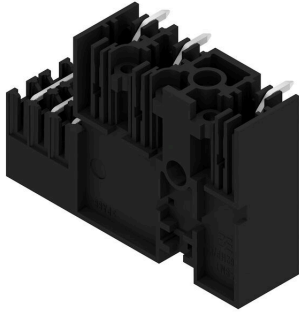

Dimensional drawing

