

WPD 109 1X185/2X35+3X25+4X16 BL

Weidmüller Interface GmbH & Co. KG
Klingenbergstraße 26
D-32758 Detmold
Germany

www.weidmueller.com

Product image

Our WPD 1XX distribution blocks are used in all situations where power is supplied and distributed. Their user-friendly design creates a better overview and enables Rapid, efficient implementation of space-saving power distribution.

General ordering data

Version	Potential distributor terminal, Screw connection, blue, 185 mm ² , 490 A, 1000 V, Number of connections: 10, Number of levels: 1
Order No.	2519490000
Type	WPD 109 1X185/2X35+3X25+4X16 BL
GTIN (EAN)	4050118531916
Qty.	1 items

WPD 109 1X185/2X35+3X25+4X16 BL

Weidmüller Interface GmbH & Co. KG
 Klingenbergstraße 26
 D-32758 Detmold
 Germany

www.weidmueller.com

Technical data

Approvals

Approvals



ROHS	Conform
UL File Number Search	UL Website
Certificate No. (cURus)	E60693

Dimensions and weights

Depth	77 mm	Depth (inches)	3.0315 inch
Height	95 mm	Height (inches)	3.7401 inch
Width	51.1 mm	Width (inches)	2.0118 inch
Net weight	455 g		

Temperatures

Storage temperature	-25 °C...55 °C	Ambient temperature	-50 °C...75 °C
Continuous operating temp., min.	-50 °C	Continuous operating temp., max.	120 °C

Environmental Product Compliance

RoHS Compliance Status	Compliant with exemption
RoHS Exemption (if applicable/known)	6c
REACH SVHC	Lead 7439-92-1
SCIP	9b5f0838-1f0b-4c14-9fc7-3f5e6ee75be2

Material data

Basic material	Wemid	Colour	blue
UL 94 flammability rating	V-0		

Rating data IECEx/ATEX

Certificate No. (ATEX)	CNEX16ATEX0005U	Certificate No. (IECEX)	IECEXCNEX16.0005U
Max. voltage (ATEX)	1100 V	Current (ATEX)	353 A
Wire cross section max. (ATEX)	185 mm ²	Max. voltage (IECEX)	1100 V
Current (IECEX)	353 A		

System specifications

Version	Screw connection	End cover plate required	No
Number of potentials	1	Number of levels	1
Number of clamping points per level	2	Number of potentials per tier	1
Levels cross-connected internally	Yes	Mounting rail	Mounting plate, TS 35
PE function	No	PEN function	No

WPD 109 1X185/2X35+3X25+4X16 BL

Weidmüller Interface GmbH & Co. KG
 Klingenbergstraße 26
 D-32758 Detmold
 Germany

www.weidmueller.com

Technical data

Additional technical data

Open sides	closed	Installation advice	Terminal rail / mounting plate
Explosion-tested version	Yes	Type of mounting	Snap-on

CSA rating data

Certificate number (cCSAus)	70128467
-----------------------------	----------

Conductors for clamping (additional connection)

Connection type, additional connection	Screw connection
----------------------------------------	------------------

Conductors for clamping (rated connection)

Wire connection cross section AWG, max.	kcmil 300	Connection direction	on side
Type of connection 2	Screw connection	Type of connection	Screw connection
Number of connections	10	Clamping range, max.	185 mm ²
Clamping range, min.	1.5 mm ²	Wire connection cross section AWG, min.	AWG 16
Wire connection cross-section, finely stranded with wire-end ferrules DIN 46228/4, min.	1.5 mm ²	Wire connection cross-section, finely stranded with wire-end ferrules DIN 46228/1, max.	150 mm ²
Wire connection cross-section, finely stranded with wire-end ferrules DIN 46228/1, min.	1.5 mm ²	Wire connection cross section, finely stranded, max.	0 mm ²
Wire connection cross section, finely stranded, min.	1.5 mm ²	Connection cross-section, stranded, max.	185 mm ²
Connection cross-section, stranded, min.	1.5 mm ²	Wire connection cross-section, solid core, max.	185 mm ²
Wire connection cross-section, solid core, min.	1.5 mm ²		

General

Number of poles	1	Wire connection cross section AWG, max.	kcmil 300
Installation advice	Terminal rail / mounting plate	Wire connection cross section AWG, min.	AWG 16
Standards	IEC 60947-7-1, UL 1059	Mounting rail	Mounting plate, TS 35

Rating data

Rated cross-section	185 mm ²	Rated voltage	1000 V
Rated AC voltage	1000 V	Rated DC voltage	1500 V
Nominal current	490 A	Current at maximum wires	490 A
Standards	IEC 60947-7-1, UL 1059	Power loss in accordance with IEC 60947-7-x	12.50 W

UL rating data

Certificate No. (cURus)	E60693
-------------------------	--------

Important note

Product information	The socket complies with flammability class V-2 according to UL94.
---------------------	--------------------------------------------------------------------

WPD 109 1X185/2X35+3X25+4X16 BL

Weidmüller Interface GmbH & Co. KG
Klingenbergstraße 26
D-32758 Detmold
Germany

www.weidmueller.com

Technical data

Classifications

ETIM 8.0	EC000897	ETIM 9.0	EC000897
ETIM 10.0	EC000897	ECLASS 14.0	27-25-01-19
ECLASS 15.0	27-25-01-19		

WPD 109 1X185/2X35+3X25+4X16 BL

Weidmüller Interface GmbH & Co. KG
 Klingenbergstraße 26
 D-32758 Detmold
 Germany

www.weidmueller.com

Drawings

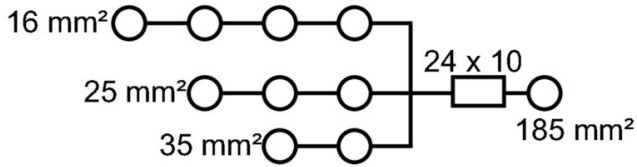

Conductor connection data according to IEC 60947-7-1 (Co)

Input	connection point A			CP** B	
	Copper	Aluminium*	CP** B	Copper	
185 mm²	19 Nm	19 Nm	22,6 Nm		
150 mm²			22,6 Nm		
125 mm²			22,6 Nm		
90 mm²			22,6 Nm		
70 mm²			22,6 Nm		
50 mm²			22,6 Nm		
Flat band 24x10mm			3 Nm		
Stripping length	27 mm		22 mm		
Allen screw	M16		W6		

Output	connection point 1 / 2 / 3			connection point 4 / 5 / 6 / 7			connection point 8 / 9	
	Copper	Aluminium*	Aluminium*	Copper	Aluminium*	Aluminium*	Copper	Aluminium*
35 mm²								
25 mm²				5,1 Nm	5,1 Nm	5,1 Nm	2,5 Nm	11,3 Nm
18 mm²				5,1 Nm	5,1 Nm	5,1 Nm	2,5 Nm	11,3 Nm
16 mm²				5,1 Nm	5,1 Nm	5,1 Nm	2,5 Nm	11,3 Nm
10 mm²				2 Nm	2 Nm	2 Nm	2,5 Nm	11,3 Nm
6 mm²				2 Nm	2 Nm	2 Nm	2,5 Nm	11,3 Nm
4 mm²				2 Nm	2 Nm	2 Nm	2,5 Nm	11,3 Nm
2,5 mm²				2 Nm	2 Nm	2 Nm	2,5 Nm	11,3 Nm
1,5 mm²				2 Nm	2 Nm	2 Nm	2,5 Nm	11,3 Nm
Stripping length	12 mm			12 mm			19 mm	
Allen screw	M6			M6			M6	

* Values according to UL 1959 ** CP: connection point

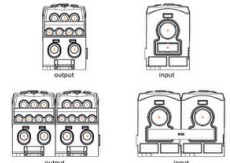

Conductor connection data according to UL 1059 (Al+Cu)

Input (line)	connection point A			CP** B	
	Copper	Aluminium	Aluminium	Copper	
kcmil 350					
kcmil 300					
kcmil 250	249,6 lb in.	249,6 lb in.	388,3 lb in.		
AWG 4/0			388,3 lb in.		
AWG 3/0			388,3 lb in.		
AWG 2/0			388,3 lb in.		
AWG 1/0			388,3 lb in.		
Flat band 24x10 mm			117 lb in.		
max. current	310 A	285 A	250 A	230 A	250 A
Voltage size B.C. (UR)	600 V				

Output	connection point 1 / 2 / 3			connection point 4 / 5 / 6 / 7			connection point 8 / 9		
	Copper	Aluminium	Aluminium	Copper	Aluminium	Aluminium	Copper	Aluminium	
AWG 2									
AWG 4				45,1 lb in.	45,1 lb in.	45,1 lb in.	100 lb in.	100 lb in.	
AWG 6				45,1 lb in.	45,1 lb in.	45,1 lb in.	100 lb in.	100 lb in.	
AWG 8				45,1 lb in.	45,1 lb in.	45,1 lb in.	100 lb in.	100 lb in.	
AWG 10	22,6 lb in.	22,6 lb in.		22,6 lb in.	22,6 lb in.	22,6 lb in.	53,1 lb in.	53,1 lb in.	
AWG 12				22,6 lb in.	22,6 lb in.	22,6 lb in.	53,1 lb in.	53,1 lb in.	
AWG 14				22,6 lb in.	22,6 lb in.	22,6 lb in.	53,1 lb in.	53,1 lb in.	
AWG 16				22,6 lb in.	22,6 lb in.	22,6 lb in.	53,1 lb in.	53,1 lb in.	
max. current	65 A	65 A	65 A	50 A	50 A	50 A	115 A	85 A	
Voltage size B.C. (UR)	600 V								

* Values according to UL 1959 ** CP: connection point

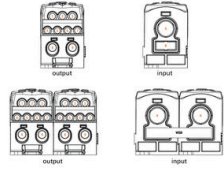

CSA rating data according to CSA 22.2 No. 150

Certificate No. (CSA)	Input		Output	
	CP** A	CP** 1/2/3	CP** 4/5/6/7	CP** B
kcmil 250				
kcmil 200				
AWG 2/0	19 Nm			
AWG 2				
AWG 4				
AWG 6				
AWG 8				
AWG 10				
AWG 12				
AWG 14				
AWG 16				
max. current	255 A	65 A	65 A	115 A
Voltage size C (CSA)	600 V			

* Values according to UL 1959 ** CP: connection point

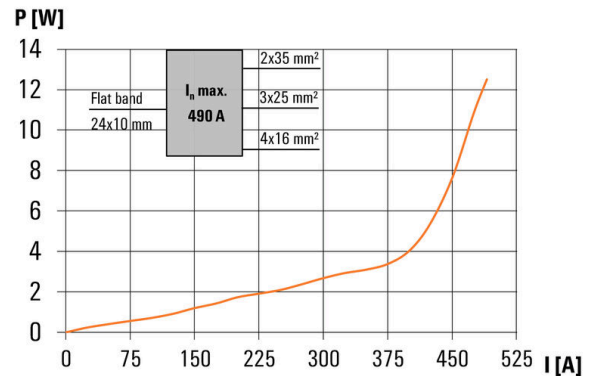
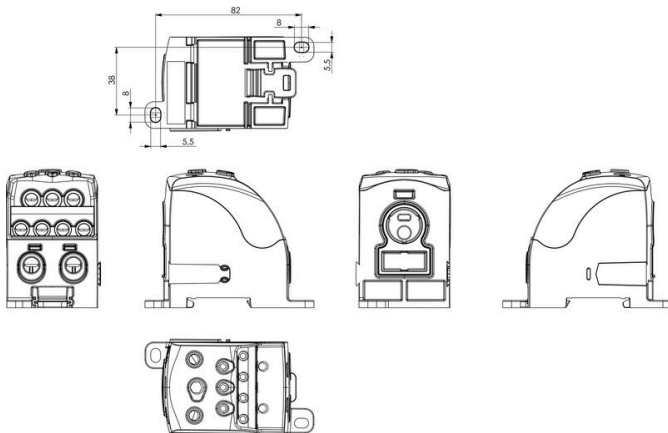
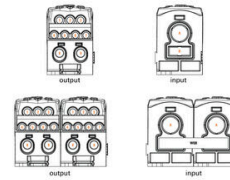

WPD 109 1X185/2X35+3X25+4X16 BL

Weidmüller Interface GmbH & Co. KG
Klingenbergstraße 26
D-32758 Detmold
Germany

www.weidmueller.com

Accessories

Socket wrench sets



Allen key made from fully hardened, high-alloy chromium-vanadium- steel, acc. to DIN ISO 2936 L (DIN 911), high-quality refined surface.

General ordering data

Type	SKS 2,0-8,0 MR	Version	
Order No.	9008870000	socket wrenches	
GTIN (EAN)	4032248266623		
Qty.	1 ST		

Slotted screwdriver



Slotted screwdriver with rounded blade SD DIN 5265, ISO 2380/2, output to DIN 5264, ISO 2380/1. ChromTop tip, SoftFinish grip

General ordering data

Type	SDS 0.6X3.5X100	Version	
Order No.	9008330000	Screwdriver, Screwdriver	
GTIN (EAN)	4032248056286		
Qty.	1 ST		

Custom printing



ESG is the tried-and-tested marker in MultiCard format for use on many well-known electrical devices. The result is high-quality device marking with a high-contrast appearance.

Various types are available for devices from manufacturers like Siemens, ABB, Beckhoff etc.

Advantages at a glance:

- Tags for universal usage, self-adhesive or clip-on tags, depending on type
- For aligned equipment, e.g. circuit breakers, we supply ESG markers for clipping onto tag rails
- Individual laser-quality printing according to specifications

For custom printing: Please send us a file of our labeling software M-Print PRO or M-Print PRO Online (without installation) for your labeling specifications.

WPD 109 1X185/2X35+3X25+4X16 BL

Weidmüller Interface GmbH & Co. KG
 Klingenbergstraße 26
 D-32758 Detmold
 Germany

www.weidmueller.com

Accessories

General ordering data

Type	ESG 9/17 K MC SDR	Version	
Order No.	1674770000	ESG, Device markers x 17 mm, PA 66, Colour: To customer	
GTIN (EAN)	4008190447656	specification, Self-adhesive	
Qty.	40 ST		

Marker holder

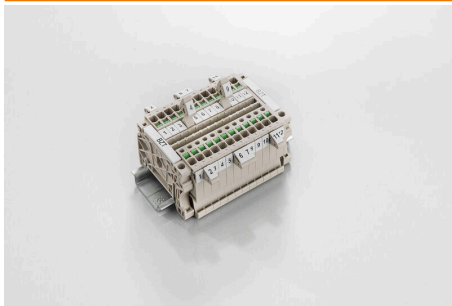

The marker holder offer the possibility of additional mounting of standard markers with a pitch of 5 or 5.1 mm. The angled holders can be optionally snapped together and could be mounted in all standard marking channels of the Klippon® Connect modular terminal blocks. Fitting marker types could be found under the respective accessories of the designation marking holder.

General ordering data

Type	BZT 1 WS 10/5	Version	
Order No.	1805490000	Accessories, Marker holder	
GTIN (EAN)	4032248270231		
Qty.	100 ST		
Type	BZT 1 ZA WS 10/5	Version	
Order No.	1805520000	Accessories, Marker holder	
GTIN (EAN)	4032248270248		
Qty.	100 ST		

Cross-connections

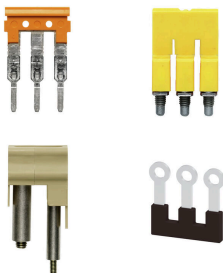

The distribution or multiplication of a potential to adjoining terminal blocks is realized via a cross-connection. Additional wiring effort can be easily avoided. Even if the poles are broken out, contact reliability in the terminal blocks is still ensured. Our portfolio offers pluggable and screwable cross-connection systems for modular terminal blocks.

General ordering data

Type	WQB WPD X08-09/2	Version	
Order No.	1561900000	Cross-connector (terminal), Plugged, grey, 353 A, Number of poles: 2,	
GTIN (EAN)	4050118367096	Pitch in mm (P): 51.10, Insulated: Yes, Width: 74.6 mm	
Qty.	3 ST		