

SAIL-7/8W7/8W-5-0.5U

Weidmüller Interface GmbH & Co. KG
Klingenbergstraße 26
D-32758 Detmold
Germany

www.weidmueller.com



Sensor/actuator cables are used for wiring sensors and actuators and for transmitting data or power in various applications. The moulded cable offers connected and tested connection of the plug-in connector to the cable ex-works. The cables may be exposed to a wide range of conditions, such as humidity, dust, heat, cold, shock or vibration.

The 7/8" cables tend to be used for power supply applications.

Is there something you have not managed to find or you feel needs explanation? Talk to us!

General ordering data

Version	Sensor/actuator line, 7/8", Number of poles : 5 (4 + PE), 0.5 m, pin, 90° - socket 90°, Shielded: No, LED: No, Sheath material: PUR, Halogen: No
Order No.	2519460050
Type	SAIL-7/8W7/8W-5-0.5U
GTIN (EAN)	4050118534306
Qty.	1 items

SAIL-7/8W7/8W-5-0.5U

Weidmüller Interface GmbH & Co. KG
 Klingenbergstraße 26
 D-32758 Detmold
 Germany

www.weidmueller.com

Technical data

Approvals

Approvals



ROHS Conform

Dimensions and weights

Net weight 90 g

Environmental Product Compliance

RoHS Compliance Status Compliant
 REACH SVHC Lead 7439-92-1
 SCIP ebf89fc8-a87f-4691-b87a-dfb9921774b4

Technical specifications for cable

Cable length	0.5 m	Sheathing colour	black
PE function	Yes	Suitable for cable carriers	Yes
Core cross-section	1.5 mm ²	Shielded	No
Halogen	No	Insulation	TPM
Bending radius, min., moving	7.5 x cable diameter	Bending cycles	5 Mio
Sheath material	PUR	Configurable cable length	No
Outer cladding in accordance with UL AWM style	20234 (80 °C / 1000 V)	Irradiation crosslinked	No
Welding spark resistance	No	Colour coding	brown, white, blue, black, Green/yellow
Torsion resistance	0 °/m	Temperature range, stationary	-50...80 °C
Resistant to welding beads	No	Temperature range, moving	-20...80 °C
Number of poles	5 (4 + PE)	Outside diameter	8.7 mm ± 0.2 mm

General technical data

Coding	none	Connection thread	7/8"
Contact surface	Au (Gold)	LED	No
Version	pin, 90° - socket 90°	Housing main material	PUR
Insulation resistance	108 Ω	Contact material	CuZn
Nominal voltage	300 V	Nominal current	9 A
Protection degree	IP68, when screwed in	Plugging cycles	≥ 100
Pollution severity	3	jumpered	No
Rated impulse voltage	2500 V	Rated voltage (UL)	600 V
Threaded ring material	Diecast zinc	Temperature range of housing	-40 ... +85 °C
Tightening torque	7/8": 1.5 Nm		

Electrical properties

Insulation resistance 108 Ω Nominal voltage 300 V

Plug, left

Plug left IP68, male contact, angled 90°, Plastic, unshielded

SAIL-7/8W7/8W-5-0.5U

Weidmüller Interface GmbH & Co. KG
Klingenbergstraße 26
D-32758 Detmold
Germany

www.weidmueller.com

Technical data**Plug, right**

Plug right	IP68, female contact, angled 90°, Plastic, unshielded
------------	---

Classifications

ETIM 8.0	EC001855	ETIM 9.0	EC001855
ETIM 10.0	EC001855	ECLASS 14.0	27-06-03-11
ECLASS 15.0	27-06-03-11		

SAIL-7/8W7/8W-5-0.5U

Weidmüller Interface GmbH & Co. KG
 Klingenbergstraße 26
 D-32758 Detmold
 Germany

www.weidmueller.com

Drawings

Dimensioned drawing

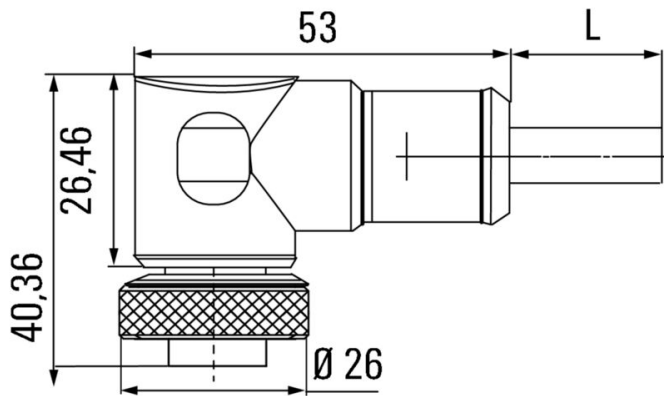

Pole scheme

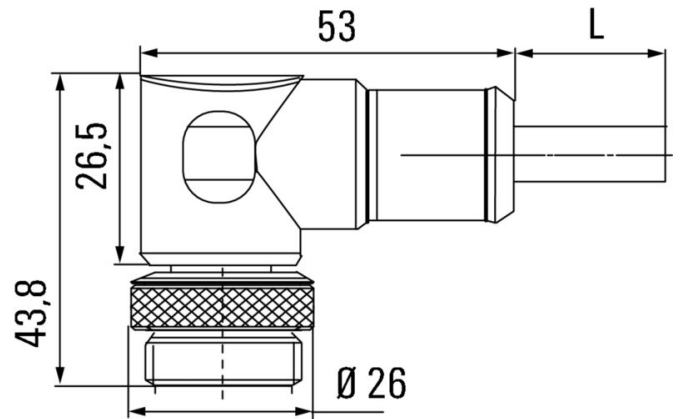

Pole scheme

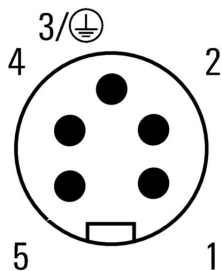

Wiring diagram

