

DRIKIT 110VDC 2CO LD

Weidmüller Interface GmbH & Co. KG
 Klingenbergstraße 26
 D-32758 Detmold
 Germany

www.weidmueller.com

Product image

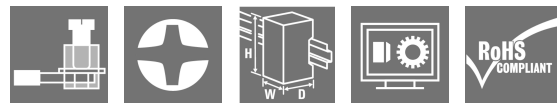

Similar to illustration

- Mounted kit consisting relay, socket and retaining clip
- 100 % function tested
- 100 % check of the dielectric strenght between input - output
- 2 CO contacts
- Optional with mechanical status indicator
- Optional Test button with coloured identification of coils (AC red / DC blue)
- Bright status LED (AC coil: red / DC coil: green)

General ordering data

Version	D-SERIES DRI, Relay module, Number of contacts: 2, CO contact AgSnO, Rated control voltage: 110 V DC, Continuous current: 5 A, Screw connection, Test button available: No
Order No.	2476840000
Type	DRIKIT 110VDC 2CO LD
GTIN (EAN)	4050118497069
Qty.	10 items

DRIKIT 110VDC 2CO LD

Weidmüller Interface GmbH & Co. KG

Klingenbergstraße 26

D-32758 Detmold

Germany

www.weidmueller.com

Technical data

Approvals

Approvals



ROHS Conform

Dimensions and weights

Depth	67.7 mm	Depth (inches)	2.6653 inch
Height	80.2 mm	Height (inches)	3.1575 inch
Width	15.8 mm	Width (inches)	0.622 inch
Net weight	64 g		

Temperatures

Storage temperature	-40 °C...85 °C	Ambient temperature	-40 °C...55 °C
Operating temperature		Humidity	35...85 % rel. humidity, no condensation

Environmental Product Compliance

RoHS Compliance Status	Compliant with exemption
RoHS Exemption (if applicable/known)	7a, 7cl
REACH SVHC	Lead 7439-92-1
SCIP	611f3393-31e7-4ef5-8360-95619a629f27

Control side

Rated control voltage	110 V DC	Rated current DC	4,8 mA
Power rating	530 mW	Coil resistance	22800 Ω ± 10 %
Status indicator	Green LED	Protective circuit	Free-wheeling diode

Load side

Rated switching voltage	250 V AC	Continuous current	5 A
Max. switching frequency at rated load	0.1 Hz	Max. switching voltage, AC	250 V
Max. switching voltage, DC	250 V	AC switching capacity (resistive), max.	1250 VA
DC switching capacity (resistive), max.	150 W @ 24 V	Switch-on delay	≤ 15 ms
Switch-off delay	≤ 10 ms	Contact type	2 CO contact (AgSnO)
Mechanical service life	10 x 10 ⁶ switching cycles	Min. switching power	10 mA @ 24 V, 10 mA @ 12 V, 100 mA @ 5 V

General data

Mounting rail	TS 35	
Test button available	No	
Mechanical switch position indicator	No	
Colour	black	
UL94 flammability rating component	Component	Housing
	UL94 flammability rating	V-2
	Component	Mounting foot
	UL94 flammability rating	HB
	Component	Retaining clip
	UL94 flammability rating	HB
Component	Relay cover	

DRIKIT 110VDC 2CO LD

Weidmüller Interface GmbH & Co. KG
 Klingenbergstraße 26
 D-32758 Detmold
 Germany

www.weidmueller.com

Technical data

UL94 flammability rating	V-2
Component	Relay baseplate
UL94 flammability rating	V-0

Insulation coordination

Rated voltage	250 V	Pollution severity	2
Surge voltage category	III	Insulating material group	IIIb
Clearance and creepage distances for control side - load side	≥ 3 mm	Dielectric strength for control side - load side	4 kVeff / 1 min
Dielectric strength of neighbouring contacts	1.5 kVeff / 1 min.	Dielectric strength of open contact	1 kVeff / 1 min
Impulse withstand voltage	4.8 kV (1.2/50 µs)	Protection degree	IP20

Further details of approvals / standards

Relevant relay	DRI424110LD	Relevant base	SDI 2CO
Certificate no. (cURus) relay	E312083	Certificate no. (cURus) base	E355547

Connection data

Wire connection method	Screw connection	Stripping length, rated connection	8 mm
Tightening torque, min.	0.5 Nm	Tightening torque, max.	0.8 Nm
Clamping range, rated connection	1.5 mm ²	Clamping range, min.	0.25 mm ²
Clamping range, max.	4 mm ²	Wire cross-section, solid, min.	0.25 mm ²
Wire cross-section, solid, max.	4 mm ²	Wire connection cross section, finely stranded, min.	0.25 mm ²
Wire connection cross section, finely stranded, max.	4 mm ²	Wire connection cross-section, finely stranded with wire-end ferrules DIN 46228/4, min.	0.25 mm ²
Wire connection cross-section, finely stranded with wire-end ferrules DIN 46228/4, max.	4 mm ²	Conductor cross-section, flexible, AEH (DIN 46228-1), min.	0.25 mm ²
Conductor cross-section, flexible, AEH (DIN 46228-1), max.	4 mm ²	Blade size	size PH1

Classifications

ETIM 6.0	EC001437	ETIM 7.0	EC001437
ETIM 8.0	EC001437	ETIM 9.0	EC001437
ETIM 10.0	EC001437	ECLASS 9.0	27-37-16-01
ECLASS 9.1	27-37-16-01	ECLASS 10.0	27-37-16-01
ECLASS 11.0	27-37-16-01	ECLASS 12.0	27-37-16-01
ECLASS 13.0	27-37-16-01	ECLASS 14.0	27-37-16-01
ECLASS 15.0	27-37-16-01		

DRIKIT 110VDC 2CO LD

Weidmüller Interface GmbH & Co. KG
 Klingenbergstraße 26
 D-32758 Detmold
 Germany

www.weidmueller.com

Drawings

Wiring diagram

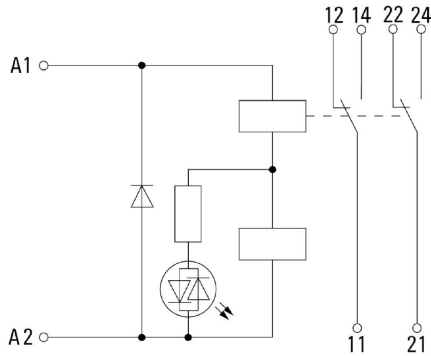

Graph

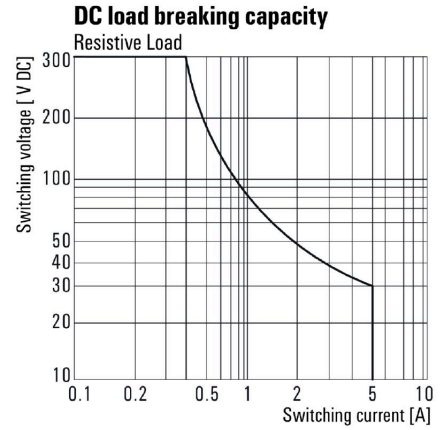

DC load limit curve Resistive load

Graph

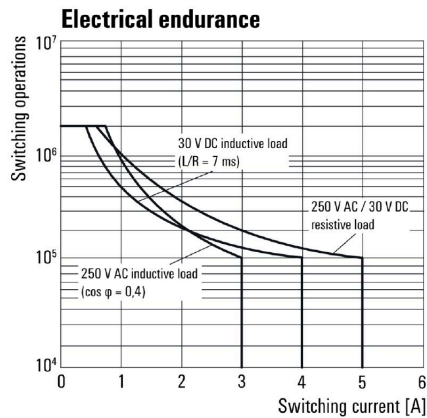

Electrical service life

Graph

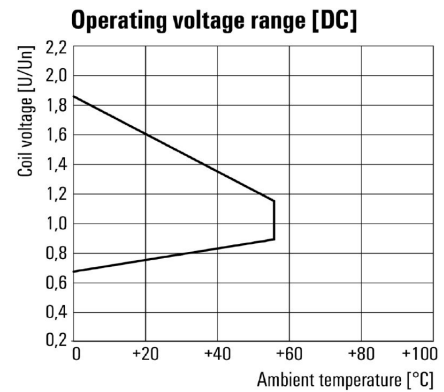

DC operational voltage range

Dimensional drawing

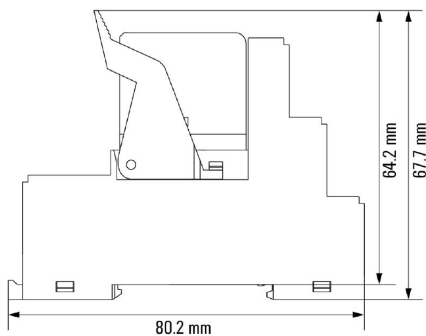

DRIKIT 110VDC 2CO LD

Weidmüller Interface GmbH & Co. KG
 Klingenbergstraße 26
 D-32758 Detmold
 Germany

Drawings

www.weidmueller.com

Miscellaneous

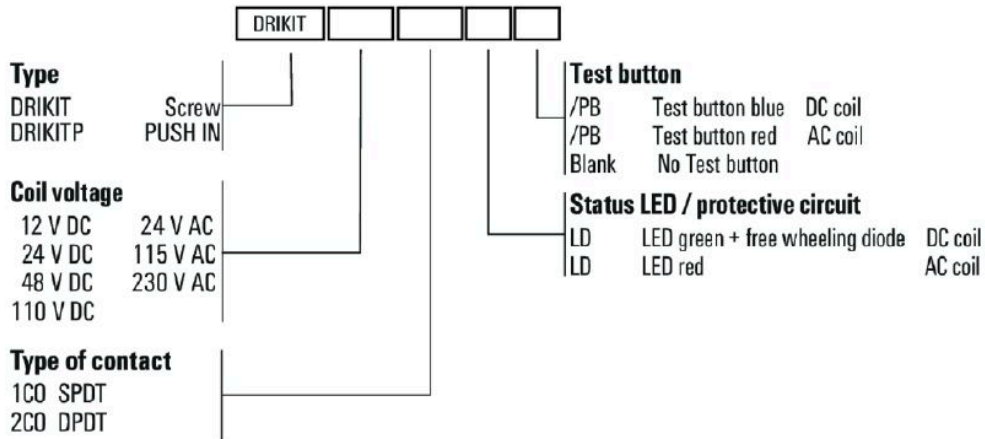

Type codes

DRIKIT 110VDC 2CO LD

Weidmüller Interface GmbH & Co. KG
 Klingenbergstraße 26
 D-32758 Detmold
 Germany

www.weidmueller.com

Accessories

Protection modules



Pluggable protective modules for the D-SERIES relay sockets, with optional protective functions.

- With free-wheeling diode or RC filter

General ordering data

Type	RIM 1 6/230VDC	Version	
Order No.	7760056169	D-SERIES, Free-wheeling diode, Rated control voltage: 6...230 V, Plug-	
GTIN (EAN)	4032248967728	in connection	
Qty.	10 ST		

LED / free-wheel diode



Pluggable protective modules for the D-SERIES relay sockets, with optional protective functions.

- With green LED and free-wheeling diode

General ordering data

Type	RIM 2 110/230VDC	Version	
Order No.	7760056017	D-SERIES, LED module with freewheel diode, Rated control voltage:	
GTIN (EAN)	4032248896615	110...230 V DC, Plug-in connection	
Qty.	10 ST		

LED



Pluggable protective modules for the D-SERIES relay sockets, with optional protective functions.

- With green LED

General ordering data

Type	RIM 3 110/230VUC	Version	
Order No.	7940018455	D-SERIES, LED module, Rated control voltage: 110...230 V UC, Plug-	
GTIN (EAN)	4032248878185	in connection	
Qty.	10 ST		

DRIKIT 110VDC 2CO LD

Weidmüller Interface GmbH & Co. KG
 Klingenbergstraße 26
 D-32758 Detmold
 Germany

www.weidmueller.com

Accessories

Cross-connection for socket with screw connection

Cross-connection for the sockets in the RIDERSERIES RCI.



General ordering data

Type	SRC-I QV S	Version	
Order No.	1132070000		RIDERSERIES RCI, Cross-connector
GTIN (EAN)	4032248912087		
Qty.	10 ST		

Retaining clips

Retaining clip for D-SERIES DRI relays
 • Metal and plastic retaining clip



General ordering data

Type	SDI CLIP LM	Version	
Order No.	7760056368		D-SERIES DRI, Retaining clip
GTIN (EAN)	6944169773341		
Qty.	10 ST		
Type	SDI CLIP P	Version	
Order No.	7760056389		D-SERIES DRI, Retaining clip
GTIN (EAN)	6944169787539		
Qty.	10 ST		

DRIKIT 110VDC 2CO LD

Weidmüller Interface GmbH & Co. KG

Klingenbergstraße 26

D-32758 Detmold

Germany

www.weidmueller.com

Accessories

Blank

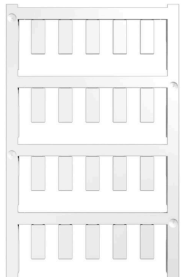

ESG is the tried-and-tested marker in MultiCard format for use on many well-known electrical devices. The result is high-quality device marking with a high-contrast appearance.

Various types are available for devices from manufacturers like Siemens, ABB, Beckhoff etc.

Advantages at a glance:

- Tags for universal usage, self-adhesive or clip-on tags, depending on type
- For aligned equipment, e.g. circuit breakers, we supply ESG markers for clipping onto tag rails
- Individual laser-quality printing according to specifications

For custom printing: Please send us a file of our labeling software M-Print PRO or M-Print PRO Online (without installation) for your labeling specifications.

General ordering data

Type	ESG 6/15 SDI MC NE WS	Version	
Order No.	2558340000	ESG, Device markers x 15 mm, PA 66, Colour: white, pluggable	
GTIN (EAN)	4050118569056		
Qty.	200 ST		

Custom printing

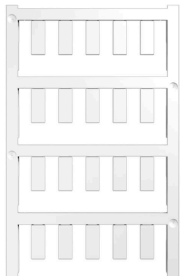

ESG is the tried-and-tested marker in MultiCard format for use on many well-known electrical devices. The result is high-quality device marking with a high-contrast appearance.

Various types are available for devices from manufacturers like Siemens, ABB, Beckhoff etc.

Advantages at a glance:

- Tags for universal usage, self-adhesive or clip-on tags, depending on type
- For aligned equipment, e.g. circuit breakers, we supply ESG markers for clipping onto tag rails
- Individual laser-quality printing according to specifications

For custom printing: Please send us a file of our labeling software M-Print PRO or M-Print PRO Online (without installation) for your labeling specifications.

General ordering data

Type	ESG 6/15 SDI MC SDR	Version	
Order No.	2558310000	ESG, Device markers x 15 mm, PA 66, Colour: To customer specification, pluggable	
GTIN (EAN)	4050118569025		
Qty.	40 ST		

DRIKIT 110VDC 2CO LD

Weidmüller Interface GmbH & Co. KG
Klingenbergstraße 26
D-32758 Detmold
Germany

www.weidmueller.com

Accessories

Crosshead screwdriver, Phillips

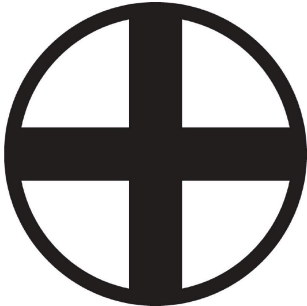

VDE insulated screwdriver sets, for working on live parts up to 1000 V AC and 1500 V DC, DIN EN 60900, IEC 900. Each piece is "GS" safety tested. Blade made from fully hardened, high-alloy chromium-vanadium-molybdenum steel, gun-metal finish.

General ordering data

Type	SDIK SLIM PH1 X 80	Version	
Order No.	2749650000	Screwdriver, Blade width (B): 1 mm, 80 mm, Blade thickness (A): 1	
GTIN (EAN)	4050118896398		
Qty.	1 ST		

Crosshead screwdriver Phillips



VDE insulated crosshead screwdriver, for Phillips screws, SDIK PH DIN 7438, ISO 8764/2-PH, output to ISO 8764-PH, SoftFinish grip

General ordering data

Type	SDIK PH1 X 80	Version	
Order No.	2749890000	Screwdriver, Blade width (B): 1 mm, 80 mm, Blade thickness (A): 1	
GTIN (EAN)	4050118897098		
Qty.	1 ST		
Type	SDK PH1 X 80	Version	
Order No.	2749410000	Screwdriver, Blade width (B): 1 mm, 80 mm, Blade thickness (A): 1	
GTIN (EAN)	4050118895636		
Qty.	1 ST		

ESG 6/15



Guaranteed long service life: ESG

The multi-colour and multi-format labels have a strong adhesive layer to ensure the best possible adhesion to the underlying surface. Double laminated polyester makes the basic material very thin and yet extremely tear-resistant.

Your benefits with MultiMark

- "Different materials for various requirements"
- Can be used with equipment from many manufacturers
- Device markers with a familiar design

DRIKIT 110VDC 2CO LD

Weidmüller Interface GmbH & Co. KG
Klingenbergstraße 26
D-32758 Detmold
Germany

www.weidmueller.com

Accessories

General ordering data

Type	ESG 6/15 MM WS	Version	
Order No.	2619940000	ESG, Device markers, 6 x 15 mm, white	
GTIN (EAN)	4050118626148		
Qty.	3000 ST		