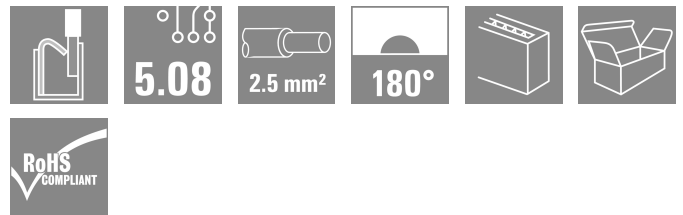
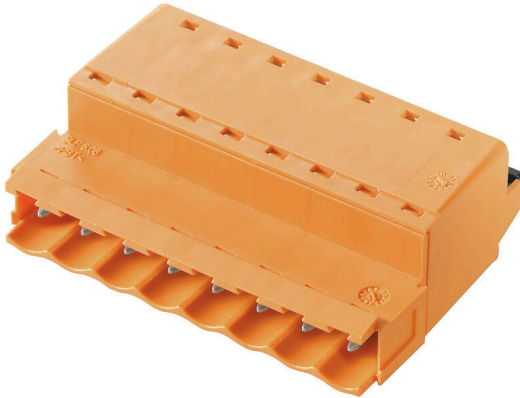

SLF 5.08/04/180B SN BK BX PRT

Weidmüller Interface GmbH & Co. KG
 Klingenbergstraße 26
 D-32758 Detmold
 Germany

www.weidmueller.com

Product image

Similar to illustration

Male plug with PUSH IN wire connection and straight outlet direction, when used with BLF 5.08HC as wire-to-wire application for panel feed-through. The male plugs provide space for labelling and can be coded.

General ordering data

Version	PCB plug-in connector, male plug, 5.08 mm, Number of poles: 4, 180°, PUSH IN with actuator, Clamping range, max. : 3.31 mm², Box
Order No.	2456790000
Type	SLF 5.08/04/180B SN BK BX PRT
GTIN (EAN)	4050118471755
Qty.	78 items
Product data	IEC: 400 V / 25.9 A / 0.2 - 2.5 mm² UL: 300 V / 14 A / AWG 26 - AWG 12
Packaging	Box

SLF 5.08/04/180B SN BK BX PRT

Weidmüller Interface GmbH & Co. KG
Klingenbergstraße 26
D-32758 Detmold
Germany

www.weidmueller.com

Technical data

Approvals

Approvals



ROHS Conform
UL File Number Search [UL Website](#)
Certificate No. (cURus) E60693

Dimensions and weights

Depth	30 mm	Depth (inches)	1.1811 inch
Height	14.2 mm	Height (inches)	0.5591 inch
Net weight	7.28 g		

Environmental Product Compliance

RoHS Compliance Status Compliant without exemption
REACH SVHC No SVHC above 0.1 wt%

System Parameters

Product family	OMNIMATE Signal - series BL/SL 5.08	Type of connection	Field connection
Wire connection method	PUSH IN with actuator	Pitch in mm (P)	5.08 mm
Pitch in inches (P)	0.200 "	Conductor outlet direction	180°
Number of poles	4	L1 in mm	15.24 mm
L1 in inches	0.600 "	Number of rows	1
Pin series quantity	1	Rated cross-section	2.5 mm ²
Touch-safe protection acc. to DIN VDE 0470	IP20 plugged/ IP10 unplugged	Protection degree	IP20
Volume resistance	≤5 mΩ	Can be coded	Yes
Stripping length	10 mm	Screwdriver blade	0.6 x 3.5
Screwdriver blade standard	DIN 5264	Plugging cycles	25
Plugging force/pole, max.	7 N	Pulling force/pole, max.	5.5 N

Material data

Insulating material	PBT	Colour	black
Colour of operational elements	orange	Colour chart (similar)	RAL 9011
Moisture Level (MSL)		UL 94 flammability rating	V-0
Contact material	Copper alloy	Contact surface	tinned
Layer structure of plug contact	4...8 μm Sn hot-dip tinned	Storage temperature, min.	-40 °C
Storage temperature, max.	70 °C	Operating temperature, min.	-50 °C
Operating temperature, max.	100 °C	Temperature range, installation, min.	-25 °C
Temperature range, installation, max.	100 °C		

Conductors suitable for connection

Clamping range, min.	0.13 mm ²
Clamping range, max.	3.31 mm ²
Wire connection cross section AWG, min.	AWG 26
Wire connection cross section AWG, max.	AWG 12
Solid, min. H05(07) V-U	0.2 mm ²
Solid, max. H05(07) V-U	2.5 mm ²
Flexible, min. H05(07) V-K	0.2 mm ²

SLF 5.08/04/180B SN BK BX PRT

Weidmüller Interface GmbH & Co. KG
 Klingenbergstraße 26
 D-32758 Detmold
 Germany

www.weidmueller.com

Technical data

Flexible, max. H05(07) V-K	2.5 mm ²			
w. plastic collar ferrule, DIN 46228 pt 4, 0.2 mm ² min.				
w. plastic collar ferrule, DIN 46228 pt 4, 2.5 mm ² max.				
w. wire end ferrule, DIN 46228 pt 1, min.	0.2 mm ²			
w. wire end ferrule, DIN 46228 pt 1, max.	2.5 mm ²			
Plug gauge in accordance with EN 60999 a x b; ø	2.8 mm x 2.0 mm			
Clampable conductor	Cross-section for conductor connection	Type	fine-wired	
		nominal	0.5 mm ²	
	wire end ferrule	Stripping length	nominal	12 mm
		Recommended wire-end ferrule	H0.5/16 OR	
		Stripping length	nominal	10 mm
		Recommended wire-end ferrule	H0.5/10	
	Cross-section for conductor connection	Type	fine-wired	
		nominal	0.75 mm ²	
	wire end ferrule	Stripping length	nominal	12 mm
		Recommended wire-end ferrule	H0.75/16 W	
		Stripping length	nominal	10 mm
		Recommended wire-end ferrule	H0.75/10	
	Cross-section for conductor connection	Type	fine-wired	
		nominal	1 mm ²	
	wire end ferrule	Stripping length	nominal	12 mm
		Recommended wire-end ferrule	H1.0/16D R	
		Stripping length	nominal	10 mm
		Recommended wire-end ferrule	H1.0/10	
	Cross-section for conductor connection	Type	fine-wired	
		nominal	1.5 mm ²	
	wire end ferrule	Stripping length	nominal	10 mm
		Recommended wire-end ferrule	H1.5/10	
		Stripping length	nominal	12 mm
		Recommended wire-end ferrule	H1.5/16 R	
Cross-section for conductor connection	Type	fine-wired		
	nominal	2.5 mm ²		
wire end ferrule	Stripping length	nominal	10 mm	
	Recommended wire-end ferrule	H2.5/14DS BL		

Reference text The outside diameter of the plastic collar should not be larger than the pitch (P). Length of ferrules is to be chosen depending on the product and the rated voltage.

Rated data acc. to IEC

tested acc. to standard	IEC 60664-1, IEC 61984	Rated current, min. number of poles (Tu=20°C)	25.9 A
Rated current, max. number of poles (Tu=20°C)	21.7 A	Rated current, min. number of poles (Tu=40°C)	22.5 A
Rated current, max. number of poles (Tu=40°C)	18.5 A	Rated voltage for surge voltage class / pollution degree II/2	400 V
Rated voltage for surge voltage class / pollution degree III/2	320 V	Rated impulse voltage for surge voltage class/ pollution degree II/2	4000 V

SLF 5.08/04/180B SN BK BX PRT

Weidmüller Interface GmbH & Co. KG
 Klingenbergstraße 26
 D-32758 Detmold
 Germany

www.weidmueller.com

Technical data

Rated impulse voltage for surge voltage class/ pollution degree III/2 4 kV
 Short-time withstand current resistance 3 x 1s with 120 A

Rated impulse voltage for surge voltage class/ contamination degree III/3 4 kV

Rated data acc. to CSA

Rated voltage (Use group B / CSA)	300 V	Rated voltage (Use group D / CSA)	300 V
Rated current (Use group B / CSA)	10 A	Rated current (Use group D / CSA)	10 A
Wire cross-section, AWG, min.	AWG 26	Wire cross-section, AWG, max.	AWG 12

Rated data acc. to UL 1059

Institute (cURus)	CURUS	Certificate No. (cURus)	E60693
Rated voltage (Use group B / UL 1059)	300 V	Rated voltage (Use group D / UL 1059)	300 V
Rated current (Use group B / UL 1059)	14 A	Rated current (Use group D / UL 1059)	10 A
Wire cross-section, AWG, min.	AWG 26	Wire cross-section, AWG, max.	AWG 12
Reference to approval values	Specifications are maximum values, details - see approval certificate.		

Packing

Packaging	Box	VPE length	354.00 mm
VPE width	136.00 mm	VPE height	38.00 mm

Type tests

Test: Durability of markings	Standard	IEC 61984 section 6.2 and 7.3.2 / 10.11, IEC 60068-2-70 / 12.95		
	Test	mark of origin, type identification, pitch, date clock, type of material		
	Evaluation	available		
	Test	durability		
Test: Misengagement (Non-interchangeability)	Evaluation	passed		
	Standard	IEC 61984 section 6.3 and 6.9.1 / 10.11, IEC 60512-13-5 / 02.06		
	Test	180° turned with coding elements		
	Evaluation	passed		
Test: Clampable cross section	Standard	IEC 60999-1 section 7 and 9.1 / 11.99, IEC 60947-1 section 8.2.4.5.1 / 03.11		
	Conductor type	Type of conductor and conductor cross-section	solid 0.5 mm ²	
		Type of conductor and conductor cross-section	stranded 0.5 mm ²	
		Type of conductor and conductor cross-section	stranded 1.0 mm ²	
		Type of conductor and conductor cross-section	solid 2.5 mm ²	
		Type of conductor and conductor cross-section	AWG 26/1	
		Type of conductor and conductor cross-section	AWG 26/19	

SLF 5.08/04/180B SN BK BX PRT

Weidmüller Interface GmbH & Co. KG
 Klingenbergstraße 26
 D-32758 Detmold
 Germany

www.weidmueller.com

Technical data

Test for damage to and accidental loosening of conductors		Type of conductor and conductor cross-section	AWG 14/1
		Type of conductor and conductor cross-section	AWG 14/19
	Evaluation	passed	
	Standard	IEC 60999-1 section 9.4 / 11.99	
	Requirement	0.2 kg	
	Conductor type	Type of conductor and conductor cross-section	AWG 26/1
		Type of conductor and conductor cross-section	AWG 26/19
	Evaluation	passed	
	Requirement	0.3 kg	
	Conductor type	Type of conductor and conductor cross-section	H05V-U0.5
Type of conductor and conductor cross-section		H05V-K0.5	
Evaluation	passed		
Requirement	0.7 kg		
Conductor type	Type of conductor and conductor cross-section	H07V-K2.5	
	Type of conductor and conductor cross-section	H07V-U2.5	
	Type of conductor and conductor cross-section	AWG 14/1	
	Type of conductor and conductor cross-section	AWG 14/19	
Evaluation	passed		
Standard	IEC 60999-1 section 9.5 / 11.99		
Requirement	≥10 N		
Conductor type	Type of conductor and conductor cross-section	AWG 26/1	
	Type of conductor and conductor cross-section	AWG 26/19	
Evaluation	passed		
Requirement	≥20 N		
Conductor type	Type of conductor and conductor cross-section	H05V-U0.5	
	Type of conductor and conductor cross-section	H05V-K0.5	
Evaluation	passed		
Requirement	≥50 N		
Conductor type	Type of conductor and conductor cross-section	H07V-K2.5	
	Type of conductor and conductor cross-section	H07V-U2.5	

SLF 5.08/04/180B SN BK BX PRT

Weidmüller Interface GmbH & Co. KG
 Klingenbergstraße 26
 D-32758 Detmold
 Germany

www.weidmueller.com

Technical data

	Type of conductor and conductor cross-section	AWG 14/1
	Type of conductor and conductor cross-section	AWG 14/19
Evaluation	passed	

Important note

IPC conformity	Conformity: The products are developed, manufactured and delivered according international recognized standards and norms and comply with the assured properties in the data sheet resp. fulfill decorative properties in accordance with IPC-A-610 "Class 2". Further claims on the products can be evaluated on request.
Notes	<ul style="list-style-type: none"> • Additional variants on request • Gold-plated contact surfaces on request • Rated current related to rated cross-section & min. No. of poles. • Wire end ferrule without plastic collar to DIN 46228/1 • Wire end ferrule with plastic collar to DIN 46228/4 • P on drawing = pitch • Crimping shape "A" for wire end ferrules with PZ 6/5 crimping tool recommended. • The test point can only be used as potential-pickup point. • In accordance with IEC 61984, OMNIMATE-connectors are connectors without breaking capacity (COC). During designated use, connectors are not allowed to be engaged or disengaged when live or under load • Long term storage of the product with average temperature of 50 °C and maximum humidity 70%, 36 months

Classifications

ETIM 8.0	EC002638	ETIM 9.0	EC002638
ETIM 10.0	EC002638	ECLASS 14.0	27-46-02-02
ECLASS 15.0	27-46-02-02		

Dimensional drawing

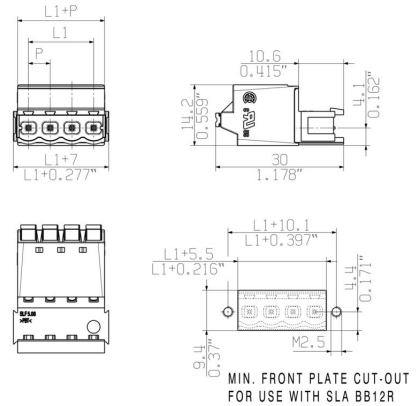

Graph

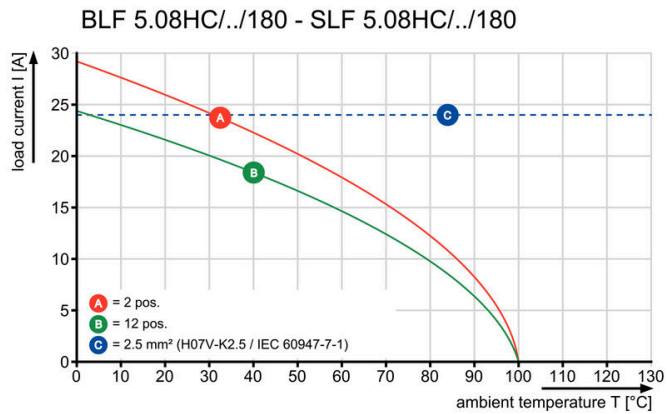

Graph

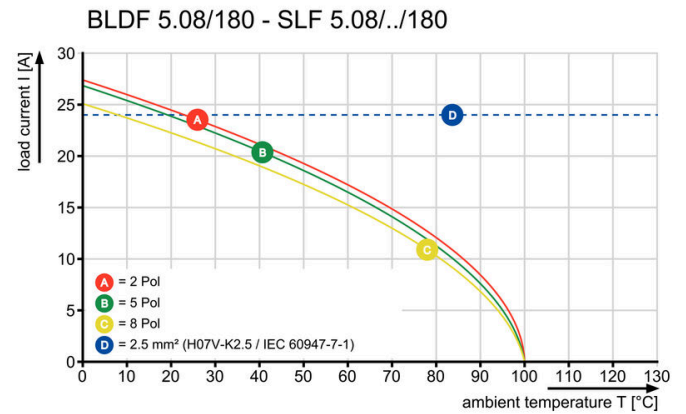

Product benefits



Uncompromising functionality High vibration resistance

Product benefits

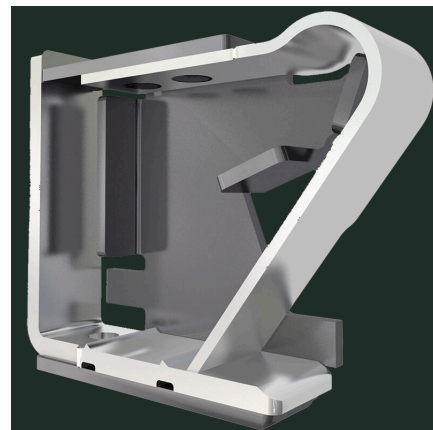

Solid PUSH IN contact Safe and durable

Drawings

Product benefits



Lower assembly costs
Secure in a matter of seconds

Product benefits

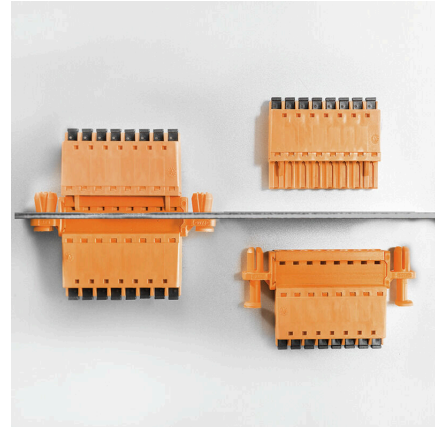

Easy handling
No implementation framework necessary