

ACT20X-HDI-SDO-P

Weidmüller Interface GmbH & Co. KG
 Klingenbergstraße 26
 D-32758 Detmold
 Germany

www.weidmueller.com

Product image, Similar to illustration



The ACT20X HDI SDO S / 2HDI-2SDO-S isolating switch amplifiers are specially designed for recording NAMUR sensor signals and digital switching signals which originate from Ex zone 0.

Negative-switching (NPN) transistor outputs are used to transmit the signals to applications in the safe zone.

Integrated alarm contacts issue an alert in the event of a malfunction; this makes troubleshooting easier and increases system availability.

The rail mounted disconnect-switch amplifiers are optionally available in one- or two-channel versions.

With 11 mm width per channel, the devices need little space in the electrical cabinet.

General ordering data

Version	EX signal isolating converter, Ex-input: NAMUR sensor/switch, Safe-output: Optocoupler, 1-channel
Order No.	2456070000
Type	ACT20X-HDI-SDO-P
GTIN (EAN)	4050118471267
Qty.	1 items

ACT20X-HDI-SDO-P

Weidmüller Interface GmbH & Co. KG

Klingenbergstraße 26

D-32758 Detmold

Germany

www.weidmueller.com

Technical data

Approvals

Approvals



ROHS Conform

UL File Number Search [UL Website](#)

Certificate no. (cULus) E337701

Dimensions and weights

Depth	114.6 mm	Depth (inches)	4.5118 inch
Height	127.3 mm	Height (inches)	5.0118 inch
Width	22.5 mm	Width (inches)	0.8858 inch
Net weight	170 g		

Temperatures

Storage temperature	-20 °C...85 °C	Operating temperature	-20 °C...60 °C
Humidity	0...95 % (no condensation)		

Probability of failure

SIL PAPER	SIL certificate - PDF/ Cert_Weidmueller_070902_P0002_C001_V2R1.pdf (application/pdf)	SIL in compliance with IEC 61508	2
MTBF	215 a		

Environmental Product Compliance

RoHS Compliance Status	Compliant with exemption
RoHS Exemption (if applicable/known)	7a, 7cI
REACH SVHC	Lead 7439-92-1
SCIP	2f6dd957-421a-46db-a0c2-cf1609156924

Assembling

Type of mounting	Snap mounting support rail	Mounting rail	TS 35
Mounting position	horizontal or vertical		

Input EX

Sensor	NAMUR sensor, according to EN60947-5-6, switch with or without RS, RP	Input frequency	0...5 kHz
Input resistance	1 kΩ	Type	intrinsically safe circuit
Sensor supply	8 V DC / 8 mA	Resistance	Series resistor 750Ω, Parallel resistor 15kΩ
Output signal in case of wire break	<0.1 mA, > 6.5 mA (in case of wire break)	Pulse duration	> 0.1 ms
NAMUR supply	8 V DC / 8 mA	Trigger level low	<1.2 mA
Trigger level high	> 2.1 mA		

ACT20X-HDI-SDO-P

Weidmüller Interface GmbH & Co. KG

Klingenbergstraße 26

D-32758 Detmold

Germany

www.weidmueller.com

Technical data

Digital output

Number of digital outputs	1	Max. switching frequency	≤ 5 kHz
Type	NPN-Transistor	Function	Output = input, direct or inverse (configurable)
Nominal switching voltage	30 V DC	Continuous current	80 mA

Output (Status)

Hysteresis	0.1 mA (switching threshold)	Type	Status relay, 1 NC (voltage-free)
Alarm function	Device error, No supply voltage, Short circuit at input, Open circuit at input	Number of alarm outputs	1
Nominal switching voltage	≤ 125 V AC / 110 V DC (safe area) ≤ 32 V AC / 32 V DC (zone 2)	Continuous current	≤ 0.5 A AC / 0.3 A DC (safe zone), ≤ 0.5 A AC / 1 A DC (zone 2)
Power rating	≤ 62.5 VA / 32 W (safe area) ≤ 16 VA / 32 W (Zone 2)		

General specifications

Type of connection	PUSH IN	Humidity	0...95 % (no condensation)
Protection degree	IP20	Supply voltage	19.2...31.2 V DC
Configuration	With FDT/DTM software, Requires configuration adapter 8978580000 CBX200 USB	Operating altitude	≤ 2000 m

Insulation coordination

EMC standards	EN 61326-1	Standards	EN 61010-1
Insulation voltage	2.6 kV (input / output)	Rated voltage	300 V

Data for Ex applications (ATEX)

ATEX - gas labelling	II (1) G [Ex ia Ga] IIC/IIB/IIA	ATEX - dust labelling	II (1) D [Ex ia Da] IIIC, I (M1) [Ex ia Ma] I
IECEx - gas labelling	Ex ec nC IIC T4 Gc, [Ex ia Ga] IIC/IIB/IIA	Installation location	Device installed in safe area, zone 2

Connection data

Type of connection	PUSH IN	Wire connection cross section AWG, min.	AWG 26
Wire connection cross section AWG, max.	AWG 14	Wire cross-section, solid, min.	0.2 mm ²
Wire cross-section, solid, max.	2.5 mm ²	Wire connection cross section, finely stranded, min.	0.2 mm ²
Wire connection cross section, finely stranded, max.	2.5 mm ²	Wire connection cross-section, finely stranded with wire-end ferrules DIN 46228/4, min.	0.2 mm ²
Wire connection cross-section, finely stranded with wire-end ferrules DIN 46228/4, max.	2.5 mm ²		

Guarantee

Time interval	3 years
---------------	---------

ACT20X-HDI-SDO-P

Weidmüller Interface GmbH & Co. KG
Klingenbergstraße 26
D-32758 Detmold
Germany

www.weidmueller.com

Technical data**Part description**

Product description The devices of the ACT20X-HDI-SDO-S family transmit digital signals galvanic isolated from potentially explosive atmospheres to non-hazardous or less hazardous areas. For this purpose the input circuits are designed intrinsically safe. They can process NAMUR sensor signals according to EN 60947-5-6 or be connected to potential-free contacts (with or without resistor circuitry).
Single and dual channel versions are available with relay or transistor outputs.

Classifications

ETIM 8.0	EC002653	ETIM 9.0	EC002653
ETIM 10.0	EC002653	ECLASS 14.0	27-21-01-20
ECLASS 15.0	27-21-01-20		

ACT20X-HDI-SDO-P

Weidmüller Interface GmbH & Co. KG
 Klingenbergstraße 26
 D-32758 Detmold
 Germany

Drawings

www.weidmueller.com

Connection diagram

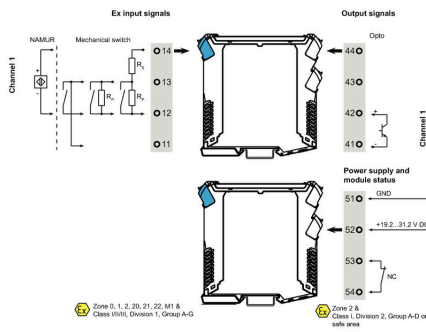

Application

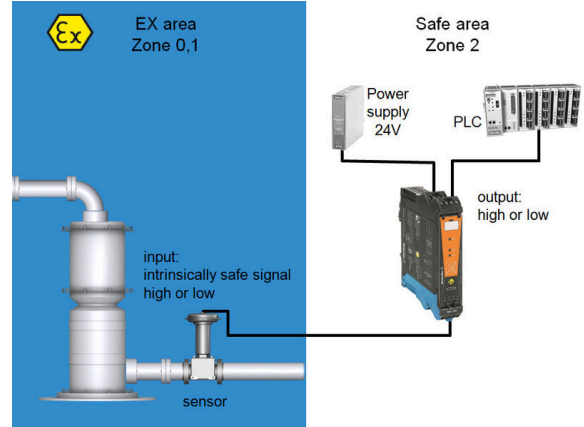

Block diagram

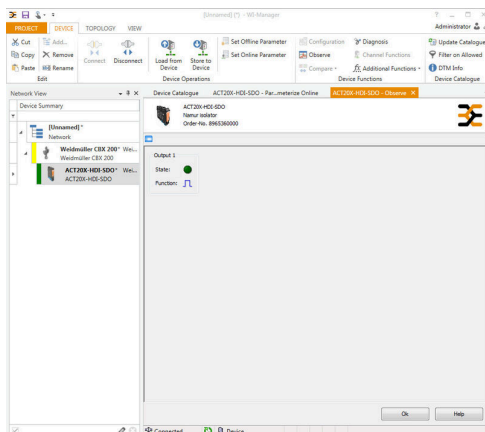
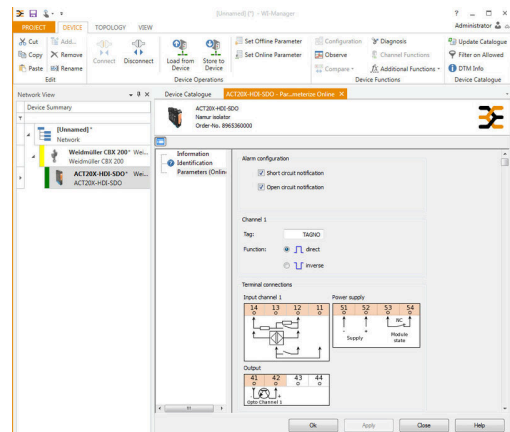
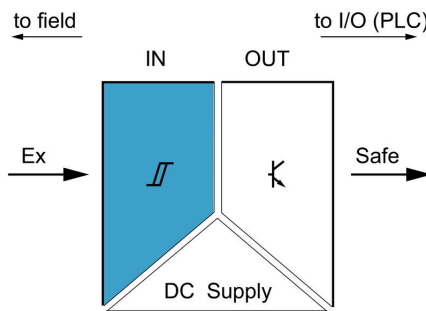

89653600004806.tif

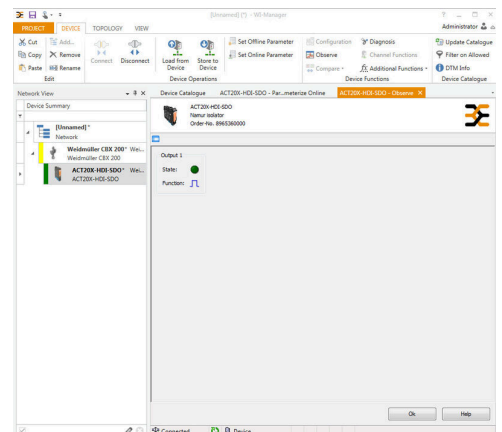

screenshot of "observe" with FDT2 / DTM software

ACT20X-HDI-SDO-P

Weidmüller Interface GmbH & Co. KG
Klingenbergstraße 26
D-32758 Detmold
Germany

Drawings

www.weidmueller.com

Dimensioned drawing

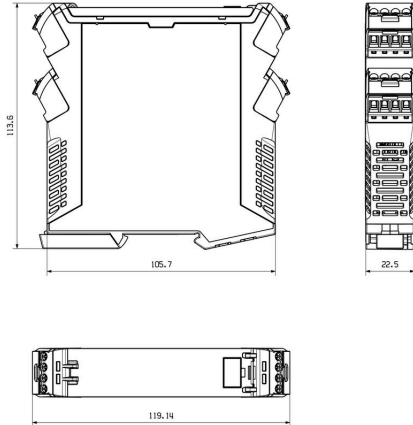

Removable terminals with coding